

Q Tesis LOC / 3
(Rojo).

ARQUITECTURA Y CONSTRUCCION
CON LADRILLOS VISTOS EN SEVILLA.
1850-1950.

Tesis Doctoral
Rafael Lucas Ruiz

Junio 1992

*Para la alumna de Arquitectura
y Arquitectura Técnica con sus mejores deseos
Julia 15 Nov-93
Rafael Ruiz*

Tomo III
Láminas

INDICE DE LAMINAS

LAMINA 0101

REPLANTEO DE PAÑOS REPLANTEO DE PAÑOS 1

Leyenda:

- m.- Valor del módulo de solape igual a un cuarto de la dimensión de la sogá.
- T.- Longitud del tizón igual a 2m.
- S.- Longitud de la sogá.
- Ls.- Longitud de la hilada superior.
- Li.- Longitud de la hilada inferior.
- A.- Ladrillo cortado situado en hilada superior.
- B.- Ladrillo cortado situado en hilada inferior.
- L.- Longitud del paño.

LAMINA 0102

REPLANTEO DE PAÑOS REPLANTEO DE PAÑOS 2

LAMINA 0103

REPLANTEO DE PAÑOS REPLANTEO DE PAÑOS 3 Y CASOS PARTICULARES

- Fig.1 Generación de paños a partir de los lados, con un tizón en la hilada superior y un tres cuartos en la hilada inferior, solapada un cuarto.
- Fig.2 Generación de paños a partir del centro, con un tizón en la hilada superior y una sogá en la hilada inferior solapada un cuarto.
- Fig.3.a Ejemplo de paño con laterales, según figura 1 y centro según figura 2, en el que hay que partir ladrillos intermedios.
- Fig.3.b Otro ejemplo del mismo caso anterior.
- Fig.4 Caso singular en el que el ladrillo de tres cuartos se sustituye por una pieza de un cuarto.
Ver Jovellanos 9. (Fot. C.50.20 y C.48.28)

LAMINA 0201

ORNAMENTACIONES SUPERFICIALES TIPOS DE SUPERFICIES ORNAMENTABLES

- Fig.1 Tímpanos de frontones.
- Fig.2 Frentes de arcos adintelados.
- Fig.3 Frentes de arcos de medio punto.
- Fig.4 Enjutas y albanegas.
- Fig.5 Tímpanos de arcos ciegos.
- Fig.6 Vacíos de arcos enjarjados.
- Fig.7 Antepechos.
- Fig.8 Balcones.
- Fig.9 Paños.
- Fig.10 Jambas.
- Fig.11 Pilastras y machones.

LAMINA 0202

ORNAMENTACIONES SUPERFICIALES PILASTRAS

- Fig.1 Ordinaria.
- Fig.2 De hiladas rehundidas.
- Fig.3 Insinuada por hiladas resaltadas.
- Fig.4 Insinuada por hiladas rehundidas.
- Fig.5 Recercada sencilla.
- Fig.6 Recercada moldurada.
- Fig.7 Acanalada.
- Fig.8 Acanalada redondeada.
- Fig.9 Sencilla de bordes redondeados.
- Fig.10 Singular de inspiración renacentista.
- Fig.11 Singular regionalista.

LAMINA 0203

ORNAMENTACIONES SUPERFICIALES MOTIVOS EN BANDA Y ARPADOS

- Fig.1 Motivo en banda por rehundido.
- Fig.2 Motivo en banda por resalte.
- Fig.3 Motivo reticulado.
- Fig.4 Motivo en banda singular, formado por hiladas de ladrillos amarillos y rojos resaltados por escalonado.
Ver Alhóndiga. 24

LAMINA 0204

ORNAMENTACIONES SUPERFICIALES
MOTIVOS ROMBADOS 1

- Fig.1 Albanegas. Estación de Córdoba.
Fig.1.a Figura básica.
Fig.1.b Simetría por giro de 180 °.
Fig.1.c Simetría por reflexión.
Fig.1.d Situación de la figura en la retícula.
Ver Armas s/n. (Fots. C.08.21 y C.08.20)

LAMINA 0205

ORNAMENTACIONES SUPERFICIALES
MOTIVOS ROMBADOS 2

- Fig.1 Hastial. Estación de Córdoba.
Fig.1.a Figura básica.
Fig.1.b Simetría por giro de 180°.
Fig.1.c Simetría por reflexión.
Fig.1.d Situación de la figura en la retícula.
Ver Armas s/n. (Fot. C.08.25)

LAMINA 0206

ORNAMENTACIONES SUPERFICIALES
MOTIVOS COMBINADOS

- Fig.1 Motivo lineal vertical a modo de pilastra insinuada, formado por tizones rehundidos.
Ver Lepanto 1.
Fig.2 Panel en damero de piezas de un cuarto resaltadas y rehundidas.
Ver Armas s/n. (Fot. C.08.28) Desaparecido kiosco bar de la Estación de Córdoba.
Fig.3 Panel arpado a sardinel de canto, combinado con motivo en banda, formado por damero de tizones pareados. Se separan ambos motivos, por hiladas tendidas resaltadas.
Ver América s/n. Pabellón Mudéjar.

LAMINA 0207

ORNAMENTACIONES SUPERFICIALES
ESGRAFIADOS, ESTUDIOS TIPO

- Fig.1 Paño rehundido con aparejo.
Fig.2 Desarrollo del dibujo.
Fig.3 Dibujo real con desarrollo de secciones.
Fig.4 Superposición de dibujo y aparejo.
Fig.5 Propuesta de mejor replanteo.
Fig.6 Propuesta de replanteo correcto.
Ver Mateos Gago 24. (Fot. C.58.15)

LAMINA 0208

ORNAMENTACIONES SUPERFICIALES
ESGRAFIADOS, TRAZADOS VARIOS 1

- Mateos Gago 24.
Fig.1 Dibujo corregido. (Fot. C.58.15)
Fig.2 Trazado
Fig.2.a Figura básica.
Fig.2.b Simetría por giro de 90°.
Fig.2.c Simetría por reflexión.
Fig.2.d Situación de la figura en la retícula.
Fig.3 Dibujo corregido. (Fot. C.58.07)
Fig.4 Trazado.
Fig.4.a Figura básica.
Fig.4.b Simetría por giro de 180°.
Fig.4.c Simetría por reflexión.
Fig.4.d Formación del dibujo definitivo por nueva simetría de giro de 90°.
Fig.4.e Líneas que generan el dibujo
Fig.5 Dibujo corregido. (Fot. C.58.10)
Fig.6 Trazado.
Fig.6.a Líneas que generan el dibujo.
Fig.6.b Dibujo básico.

LAMINA 0209

ORNAMENTACIONES SUPERFICIALES
ESGRAFIADOS, TRAZADOS VARIOS 2

Mateos Gago 24.

- Fig.7 Dibujo corregido. (Fot. C.58.13)
- Fig.8 Trazado.
- Fig.8.a Figura básica.
- Fig.8.b Simetría por reflexión.
- Fig.8.c Formación del dibujo por traslación.
- Fig.9 Dibujo corregido. (Fot. C.58.12)
- Fig.10 Trazado.
- Fig.10.a Figura básica.
- Fig.10.b Simetría por giro de 180°.
- Fig.10.c Simetría por reflexión.
- Fig.10.d Situación de la figura en la retícula.

LAMINA 0210

ORNAMENTACIONES SUPERFICIALES
ESGRAFIADOS 3

Mateos Gago 24. (Fot. C.58.19)

- Fig.1 Trazado.
- Fig.1.a Dibujo básico.
- Fig.1.b Simetría por giro de 90°.
- Fig.1.c Simetría por reflexión.
- Fig.1.d Situación de la figura en la retícula.
- Fig.2 Dibujo situado en la enjuta.

LAMINA 0301

ARCOS Y DINTELES
TIPOS DE APOYOS Y ARRANQUES

- Fig.1 Dintel, apoyo a inglete.
- Fig.2 Dintel, apoyo escalonado.
- Fig.3 Dintel, apoyo ordinario.
- Fig.4 Dintel con apoyo oculto.
- Fig.5 Dintel acordado a modo de arco deprimido.
- Fig.6 Arco adintelado, arranque ordinario.
- Fig.7 Arco adintelado, arranque sobre escalonado.
- Fig.8 Arco rebajado en correa, arranque horizontal.
- Fig.9 Arco rebajado, arranque ordinario paramentado.
- Fig.10 Arco rebajado, arranque ordinario resaltado.
- Fig.11 Arco rebajado, arranque sobre ménsula.
- Fig.12 Arco rebajado, arranque a inglete.
- Fig.13 Arco rebajado, arranque acordado.

LAMINA 0302

ARCOS Y DINTELES
ESTUDIO DE ARCOS ADINTELADOS

- Fig.1 Frente de un pie. Replanteo para aparejo de sogas.
- Fig.2 Frente de un pie. Replanteo para aparejo a sogas y tizón.
- Fig.3 Frente de un pie y medio. Replanteo para juntas horizontales simétricamente dispuestas.
- Fig.4 Frente de un pie y medio. Replanteo para juntas horizontales que dividen el frente en tres partes iguales.
- Fig.5 Frente de un pie y medio. Replanteo para juntas concéntricas naturales.
- Fig.6 Frente de dos pies. Replanteo con juntas horizontales asimétricas.
- Fig.7 Frente de dos pies. Replanteo con juntas horizontales simétricas.
- Fig.8 Frente de dos pies. Replanteo con juntas horizontales que dividen el frente en partes iguales.

LAMINA 0303

ARCOS Y DINTELES
ARCOS ADINTELADOS, TIPOS DE APAREJOS

- Fig.1 Frente de un pie con aparejo de sogas.
- Fig.2 Frente de un pie con aparejo de sogas y tizones. Junta horizontal asimétrica.
- Fig.3 Frente de un pie con aparejo de sogas y tizones. Junta horizontal simétrica.
- Fig.4 Frente de un pie con aparejo de sogas y tizones. Juntas concéntricas naturales.
- Fig.5 Frente de un pie con aparejo en bolsón.
- Fig.6 Frente de un pie y medio. Juntas horizontales.
- Fig.7 Frente de un pie y medio. Juntas naturales.
- Fig.8 Frente de dos pies. Juntas horizontales repartidas.
- Fig.9 Frente de dos pies. Juntas horizontales concentradas.

LAMINA 0304

ARCOS Y DINTELES

FIGURAS DE ARCOS ADINTELADOS Y DINTELES CON
TRASDOS SINGULAR

- Fig.1 Alameda 63.
- Fig.2 Castellar 65.
- Fig.3 Calatrava 24.
- Fig.4 Constitución 6.
- Fig.5 Doctor Letamendi 3.
- Fig.6 Doña María Coronel 3.
- Fig.7 Encarnación 2.
- Fig.8 Francos 34.
- Fig.9 Jerónimo Hernández 28.
- Fig.10 Mateos Gago 22.
- Fig.11 Juan de Avila 17.
- Fig.12 Museo 3.

LAMINA 0305

ARCOS Y DINTELES

APAREJOS SINGULARES DE ARCOS ADINTELADOS

- Fig.1 Modelo de aparejo de arco adintelado con trasdós rebajado.
Ver Santander 3,5 y 7.
- Fig.2 Arco compuesto por arco adintelado con trasdós rebajado, y arco de correa a tizón de dos hiladas. Se representa una hilada a tizón para regularización del desacuerdo existente entre paños.
Ver Yuste 12.
- Fig.3 Arco adintelado con su frente dividido en tres cuerpos por juntas horizontales, el superior dentellado por rehundido.
Ver Palacios Malaver 18.
- Fig.4 Arcos en bolsón pareados, en composición simétrica.
Ver Cristóbal Colón 16, 17, 18 y 19, fachada a Velarde. (Fot. C.28.31)

LAMINA 0306

ARCOS Y DINTELES

APAREJOS DE ARCOS REBAJADOS

- Fig.1 Arco rebajado de correa a tizón de una hilada.
- Fig.2 Arco rebajado de correa a tizón de dos hiladas.
- Fig.3 Arco rebajado a sardinel.
- Fig.4 Arco rebajado con aparejo de sogas.
- Fig.5 Arco rebajado con aparejo a soga y tizón.
- Fig.6 Arco rebajado de un pie y medio.
- Fig.7 Arco rebajado de dos pies.
- Fig.8 Arco rebajado de dos pies y medio.
- Fig.9 Arcos rebajado de roscas a sardinel.
- Fig.10 Arco rebajado con el frente dispuesto en dos planos.

LAMINA 0307

ARCOS Y DINTELES

ARCOS REBAJADOS CON TRASDOS SINGULAR

- Fig.1 Arco rebajado compuesto por: arco ordinario de pie y medio, arco de correa de una hilada a tizón resaltado un octavo, arco a sardinel resaltado un cuarto y arco de correa a tizón de una hilada resaltado un octavo. La hilada a sardinel se cierra con tres tizones en disposición tendida.
Ver Arrayán 23,25 y 27.
- Fig.2 Arco rebajado de dos pies, con trasdós dentellado por rehundido de un tizón. Se cierra con guardapolvos formado por una hilada a tizón a modo de arco de correa que continúa como imposta.
Ver Arte de la Seda 17.
- Fig.3 Arco rebajado con trasdós en ángulo.
Ver Doctor Fedriani s/n, Cementerio, edificios de servicios (Fot. C.37.08)
- Fig.4 Arco rebajado con trasdós también rebajado de menor radio de curvatura.
Ver Panteón 020. (Fot. C.37.11)

LAMINA 0308

ARCOS Y DINTELES

ARCOS SINGULARES DE MEDIO PUNTO

- Fig.1 Guardapolvo formado por un arco de correa de una hilada a tizón dentellada.
Ver Mateos Gago 2. (Fot. C. 16.14)
- Fig.2 Arco de medio punto de un pie de frente, con trasdós denticulado por resalte de un cuarto.
Ver Tarifa 4. (Fot. C.09.30)
- Fig.3 Arco de medio punto con frente dentellado por resalte de una dovela alterna.
Ver Cristobal Colón 16,17,18 y 19, fachada a Velarde. (Fot. C.28.30)
- Fig.4 Arco de medio punto con aparejo continuado hasta llenar la enjuta.
Laraña 2, (Fots. C.34.26 y C.34.25) ver también Santo Tomás 17.

LAMINA 0309

ARCOS Y DINTELES

ARCOS RECTILINEOS Y MIXTILINEOS

- Fig.1 Arco rectilíneo ciego, aparejado con tirantez al centro.
Ver San Bernardo 46. (Fot. C.40.21)
- Fig.2 Arco rectilíneo ciego, de hiladas tendidas.
- Fig.2.a Mejor solución del arco anterior.Modelo.
- Fig.3 Falso arco rectilíneo ciego de hiladas tendidas.
Doctor Fedriani s/n. (Fot. C.36.35 y Fot. C.41.20)
- Fig.4 Arco rectilíneo de hiladas paralelas con clave de piedra.
San Jacinto 5. (Fot. C.31.16)
- Fig.5 Arco mixtilíneo con aparejo de cinco centros.
- Fig.5.a Modelo de trazado geométrico.
- Fig.5.b Modelo de reparto de dovelas
Lineros 21. (Fot. C.34.31 y SR.44)

LAMINA 0310

ARCOS Y DINTELES

ARCOS FLORENTINO Y DEPRIMIDO

- Fig.1 Arco florentino, con tirantez al centro y distribución uniforme de juntas concéntricas en cada dovela, un medio para las dovelas de dos ladrillos y un cuarto, un medio y un cuarto para las de tres piezas.
- Fig.1.a Modelo del trazado geométrico.
- Fig.1.b Modelo del trazado de líneas de juntas.
- Fig.1.c Modelo para la rectificación del trazado de la junta.
- Fig.1.d Modelo con juntas rectificadas.
Ver Mercedarias s/n. (Fot. C.38.11)
- Fig.2 Arco deprimido de tres centros.
Ver Villasís 1. (Fot. C.15.16)

LAMINA 0401

DOSELES Y FRONTONES

DOSELES NEOCLASICOS

- Fig.1 Dosel neoclásico de sección escalonada.
- Fig.2 Dosel neoclásico de sección moldurada por tallado o premoldeado.
- Fig.3 Dosel neoclásico con molduras.
- Fig.4.a Modelo de replanteo de dosel, iniciado por el centro.
- Fig.4.b Modelo terminado, el ajuste se realiza con ladrillos partidos en los extremos.
- Fig.4.c Modelo de replanteo de dosel iniciado por los extremos.
- Fig.4.d Modelo terminado, el ajuste se realiza con ladrillos partidos en el centro.

LAMINA 0402

DOSELES Y FRONTONES

DOSELES DENTELLADOS 1

- Fig.1 Dosel dentellado. (Fot. C.55.17)
- Fig.2 Dosel dentellado. (Fot. C.55.20)
- Fig.3 Dosel dentellado. (Fot. C.54.03)
- Fig.4 Dosel dentellado. (Fot. C.54.01)
Ver Carretera de Cádiz s/n. (1)

LAMINA 0403
DOSELES Y FRONTONES
DOSELES DENTELLADOS 2

- Fig.5 Dosele dentellado. (Fot. C.55.19)
Fig.6 Dosele dentellado. (Fots. C.54.09 y 54.06)
Ver Carretera de Cádiz s/n. (1)

LAMINA 0404
DOSELES Y FRONTONES
FIGURAS DE FRONTONES TIPOS

- Fig.1 Figura de frontón triangular.
Fig.2 Figura de frontón triangular partido.
Fig.3 Figura de frontón triangular desventrado.
Fig.4 Figura de frontón triangular partido y desventrado.
Fig.5 Figura de frontón circular.
Fig.6 Figura de frontón circular partido.
Fig.7 Figura de frontón circular partido con volutas.
Fig.8 Figura de frontón de inflexión.
Fig.9 Figura de frontón de inflexión desventrado.

LAMINA 0405
DOSELES Y FRONTONES
FIGURAS DE FRONTONES SINGULARES

- Fig.1 Feria 105.
Fig.2 Arfe 5.
Fig.3 Santas Patronas 39.
Fig.4 Mateos Gago 3.
Fig.5 Mateos Gago 3.
Fig.6 Mateos Gago 5.
Fig.7 Monsalves 2.
Fig.8 Mateos Gago 2.
Fig.9 Teniente Vargas Zúñiga 2 y 4.
Fig.10 Lineros 21. (Fot. C.34.36)
Fig.11 Saucedá 2.
Fig.12 Villegas 1 y 3.

LAMINA 0406
DOSELES Y FRONTONES
EVOLUCION COMPOSITIVA DE FRONTONES

- Fig.1 Frontón básico.
Fig.2 Frontón con guardapolvos.
Fig.3 Frontón con guardapolvos e imposta.
Fig.4 Frontón completo con acróteras y canes.
Fig.5 Frontón con decoración del tímpano.
Fig.6.a Denticulado Regionalista de frontón.
Fig.6.b Denticulado clásico de frontón.
Fig.7.a Acuerdo ordinario de lados.
Fig.7.b Acuerdo singular de lados.

LAMINA 0407
DOSELES Y FRONTONES
SECCIONES CONSTRUCTIVAS BASICAS

- Fig.1 Sección escalonada de hiladas tendidas.
Fig.2 Sección moldurada de hiladas tendidas.
Fig.3 Sección moldurada y con molduras de hiladas tendidas.
Fig.4 Sección escalonada, moldurada y con molduras de hiladas tendidas.
Fig.5 Sección escalonada de hilada a sardinel.
Fig.6 Sección moldurada de hilada a sardinel.
Fig.7 Sección escalonada y moldurada de hiladas a sardinel.
Fig.8 Sección combinada de hiladas tendidas y a sardinel.

LAMINA 0408
DOSELES Y FRONTONES
CONSTRUCCION DE FRONTONES

- Fig.1 Frontón básico construido con secciones de hiladas tendidas.
Fig.2 Frontón combinado. Formado por frontón básico construido con secciones de hiladas tendidas y guardapolvos, construido con sección de hilada a sardinel.
Fig.3 Frontón construido íntegramente con secciones de hiladas tendidas.
Fig.4 Frontón construido íntegramente con hiladas a sardinel.

LAMINA 0501

CERCOS Y OCULOS
CERCOS RECTANGULARES

- Fig.1 Cerco rectangular singular.
Ver San Jacinto 25 y 27.
- Fig.2.a Cerco rectangular de hiladas a sardinel y a tizón combinadas. Modelo.
- Fig.2.b Cerco existente.
Ver Calatava 24.
- Fig.3 Cerco rectangular con borde de molduras.
Ver San Pablo 17.
- Fig.4 Cerco rectangular de sección moldurada.
Ver Arfe 5.
- Fig.5 Cerco formado por una hilada tendida de ladrillo con molduras.

LAMINA 0502

CERCOS Y OCULOS
APAREJOS Y SECCIONES DE CERCOS CIRCULARES

- Fig.1 Aparejo con juntas concurrentes y ladrillo ordinario.
- Fig.2 Aparejo con juntas paralelas y ladrillo cortado.
- Fig.3 Aparejo con juntas concurrentes y ladrillo escafilado.
- Fig.4 Aparejo de hiladas tendidas a tizón.
- Fig.5 Oculo construido con ladrillos premoldeados específicamente.
Ver Buen Suceso s/n.
- Fig.6 Cerco circular dentellado.
- Fig.7 Sección de cerco escalonada y moldurada.
- Fig.8 Sección de cerco moldurada singular.
Ver San Pablo s/n.
- Fig.9 Sección de cerco de ladrillo moldurados premoldeados en serie.

LAMINA 0503

CERCOS Y OCULOS
OCULOS CIRCULARES

- Fig.1 Oculo compuesto por hiladas a sardinel y tendidas, con ejes acentuados.
Ver Calatrava 24. (Fot. C.28.20)
- Fig.2 Oculo dentellado en bloques de cinco ladrillos.
Ver Juan de Avila 17. (Fot. C.23.8)
- Fig.3 Oculo combinado de tramos rectos y circulares.
Ver Francos 37. (Fot. C.18.30)

LAMINA 0504

CERCOS Y OCULOS
CERCOS Y OCULOS CIRCULARES

- Fig.1 Cerco arpado.
Ver Castellar 65.
- Fig.2 Oculo polilobulado.
Ver Martín Villa s/n. (Fot. C.34.2)
- Fig.3.a Cerco ovalado. Modelo con aparejo coherente.
- Fig.3.b Cerco ovalado. Modelo aparejado con tirantez al centro geométrico de la figura.
Ver Palmera s/n. (Fot. C.62.32 y C.62.33)

LAMINA 0505

CERCOS Y OCULOS
OCULO DENTELLADO

- Fig.1 Rosetón dentellado singular.
Ver Mercedarias s/n.

LAMINA 0506
CERCOS Y OCULOS
CERCOS COMBINADOS

- Fig.1 Oculo mixtilíneo con borde de molduras.
Fig.1.a Solución existente.
Fig.1.b Modelo.
Ver Gerona 2. (Fot. C.10.04)
Fig.2 Cerco rectilíneo en estrella de ocho puntas.
Fig.2.a Solución constructiva existente.
Fig.2.b Modelo.
Fig.2.c Modelo.
Fig.2.d Modelo.
Fig.2.e Modelo.
Ver Ramón y Cajal s/n, Matadero. (Fot. S.R.
23)

LAMINA 0601
IMPOSTAS Y CORNISAS
TIPOS DE MODILLONES

- Fig.1 Modillón sencillo, de hiladas tendidas.
Fig.2 Modillón escalonado, de hiladas tendidas.
Fig.3 Modillón escalonado y con ladrillos moldurados, de hiladas tendidas.
Fig.4 Modillón escalonado y moldurado, de hiladas tendidas.
Fig.5 Modillón sencillo con remate volado, de hiladas tendidas.
Fig.6 Modillón de doble escalonado, de hiladas tendidas.
Fig.7 Modillón sencillo a sardinel.
Fig.8 Modillón moldurado a sardinel.
Fig.9 Modillón, de frente tallado.
Fig.10 Modillón tallado.
Fig.11 Modillón pareado con remate volado moldurado.

LAMINA 0602
IMPOSTAS Y CORNISAS
TIPOS DE IMPOSTAS SENCILLAS

- Fig.1.a Imposta simple de una hilada tendida a tizón.
Fig.1.b Imposta simple de una hilada tendida a sogá.
Fig.2 Imposta simple de una hilada a sardinel.
Fig.3 Imposta simple de una hilada a sardinel de canto.
Fig.4 Imposta sencilla de varias hiladas tendidas.
Fig.5 Imposta escalonada de hiladas tendidas.
Fig.6 Imposta escalonada y moldurada de hiladas tendidas.
Fig.7 Imposta escalonada moldurada y con molduras de hiladas tendidas.
Fig.8 Imposta moldurada de hiladas tendidas.
Fig.9 Imposta moldurada a sardinel.

LAMINA 0603
IMPOSTAS Y CORNISAS
TIPOS DE IMPOSTAS DENTELLADAS Y ARPADAS

- Fig.1 Imposta dentellada a modo de denticulos.
Fig.2 Imposta dentellada a sardinel en banda.
Fig.3 Imposta dentellada a sardinel de canto en banda.
Fig.4 Imposta arpada simple, de hilada tendida.
Fig.5 Imposta arpada de hilada tendida en banda.
Fig.6 Imposta arpada a sardinel en banda.
Fig.7 Imposta arpada a sardinel de canto en banda.

LAMINA 0604
IMPOSTAS Y CORNISAS
IMPOSTAS DENTELLADAS SINGULARES

- Fig.1 Imposta escalonada y dentellada a tizón.
Fig.2 Imposta con motivo de dados de un cuarto en banda.
Fig.3 Imposta con motivo dentellado en banda.
Fig.4 Imposta festoneada sencilla.
Fig.5 Imposta dentellada de ladrillos a sogá en banda.
Fig.6 Imposta en damero dentellado de tres tizones, también "en fondo de cesta".
Ver Becas 10. (Fot. C.44.06)

LAMINA 0605
IMPOSTAS Y CORNISAS
IMPOSTAS DENTELLADA Y FESTONEADAS 1

- Fig.1 Imposta festoneada sencilla.
Ver San Jacinto 5.
Fig.2 Imposta dentellada en banda.
Ver Luis Montoto 3 y 5.
Fig.3 Imposta festoneada.
Ver Castellar 65.

LAMINA 0606
IMPOSTAS Y CORNISAS
IMPOSTAS FESTONEADAS 2

- Fig.4.a Imposta festoneada sobre pilarillos. Modelo.
Fig.4.b Imposta anterior realmente construida.
Ver Baños 76.
Fig.5 Imposta festoneada sobre pilarillos.
Ver Becas 10.

LAMINA 0607
IMPOSTAS Y CORNISAS
IMPOSTA FESTONEADA 3

- Fig.6 Imposta festoneada.
Ver Luis Montoto 3 y 5.

LAMINA 0608
IMPOSTAS Y CORNISAS
IMPOSTAS SINGULARES

- Fig.1 Imposta singular de pilarillos redondeados en banda.
Ver San Miguel 6.
Fig.2 Imposta singular de elementos moldurados, arpados y tallados.
Ver Sor Angela de la Cruz 33.
Fig.3 Imposta arpada en columnilla, en banda.
Santas Patronas 48 y 50.
Fig.4 Imposta singular formada por motivos premoldeados y tallados.
Ver Nueva 5.

LAMINA 0609
IMPOSTAS Y CORNISAS
TIPOS DE CUERPOS VOLADOS

- Fig.1 Cuerpo volado de sección escalonada sencilla, de hiladas tendidas.
Fig.2 Cuerpo volado de sección escalonada y moldurada.
Fig.3 Cuerpo volado de sección moldurada.
Fig.4 Cuerpo volado de sección en envolvente triangular.
Fig.5 Cornisa de sección escalonada y moldurada en dos cuerpos volados.
Fig.6 Cornisa de sección triangular, moldurada y con molduras.

LAMINA 0610
IMPOSTAS Y CORNISAS
TIPOS DE CORNISAS

- Fig.1 Cornisa sencilla formada por cuerpo volado.
Fig.2 Cornisa formada por imposta y cuerpo volado.
Fig.3 Cornisa formada por cuerpo volado sobre modillones.
Fig.4 Cornisa completa formada por cuerpo volado sobre modillones e imposta.

LAMINA 0611
IMPOSTAS Y CORNISAS
CORNISAS SINGULARES 1

- Fig.1 Cornisa Neomedieval de motivo tallado.
Ver Doctor Fedriani s/n. Cementerio. Depósito de cadáveres. (Fot. C.37.06.)
Fig.2 Cornisa arpada a sardinel de canto y con hiladas tendidas.
Ver Calatrava

LAMINA 0612
IMPOSTAS Y CORNISAS
CORNISAS SINGULARES 2

- Fig.3 Navarros 55.
- Fig.4 Puente y Pellón 19.
- Fig.5 Amor de Dios 23. (Fots. C.66.05 y C.66.06)
- Fig.6 Feria 68.
- Fig.7 Guadiana 8.

LAMINA 0613
IMPOSTAS Y CORNISAS
CORNISAS SINGULARES 3

- Fig.8 Ramón y Cajal s/n.

LAMINA 0701
ALMENADOS, CRESTERIAS, ANTEPECHOS Y BALCONES
ALMENADOS

- Fig.1 Alvarez Quintero 20. (Fot.P043)
- Fig.2 Laraña s/n(1).
- Fig.3 Baños 76.
- Fig.4 Baños 76.
- Fig.5 Carretera de Cádiz s/n(2). (Fot.C.57.14)
- Fig.6 Carretera de Cádiz s/n(2). (Fot.C.56.24)
- Fig.7 Carretera de Cádiz s/n(2). (Fot.C.56.25)

LAMINA 0702
ALMENADOS, CRESTERIAS, ANTEPECHOS Y BALCONES
CRESTERIAS

- Fig.1.a Paño donde se ha de implantar la crestería.
- Fig.1.b Recorte de ambos lados.
- Fig.1.c División par, en partes iguales.
- Fig.1.d Módulo de replanteo.
- Fig.1.e Figura rectilínea elegida.
- Fig.1.f Figura obtenida por simetría de reflexión.
- Fig.1.g Situación de la figura en el paño.
- Fig.2 Maese Rodrigo, crestería lateral.
- Fig.3 Omnium Sanctórum.
- Fig.4 San Pedro.
- Fig.5 Campanario Maese Rodrigo.
- Fig.6 Estación de Córdoba.
- Fig.7 Matadero.
- Fig.8 Subestaciones de la Compañía Catalana de gas y Electricidad.
- Fig.9 Costurero de la Reina.

LAMINA 0703
ALMENADOS, CRESTERIAS, ANTEPECHOS Y BALCONES
EVOLUCION DEL ANTEPECHO

- Fig.1 Casa con tejado.
- Fig.2 Casa con paño-baranda.
- Fig.3 Casa con paño-baranda o antepecho ciego, con ornamentación sencilla.
- Fig.4 Casa con antepecho de elementos sencillos de sostén y barandilla.
- Fig.5 Antepecho con elementos de sostén con remate, y barandilla.
- Fig.6 Antepecho con elementos de sostén con remates, que arrancan de debajo de la cornisa.
- Fig.7 Sección de casa con tejado.
- Fig.8 Sección de casa con paño baranda.
- Fig.9 Sección de casa con azotea y baranda.

LAMINA 0704

ALMENADOS, CRESTERIAS, ANTEPECHOS Y BALCONES
ANTEPECHOS SINGULARES 1

- Fig.1 Doña María Coronel 3.
- Fig.2 Navarros 55.
- Fig.3 Eduardo Cano 10.
- Fig.4 San Juan de la Palma 24.
- Fig.5 Doctor Fedriani s/n. (Fot.C.37.07)

LAMINA 0705

ALMENADOS, CRESTERIAS, ANTEPECHOS Y BALCONES
ANTEPECHOS SINGULARES 2

- Fig.6 Antepecho singular en forma de olas.
Ver Villasís 1. (Fot.C.09.10)
- Fig.7 Alonso el Sabio 3.
- Fig.8 San Pedro s/n.
- Fig.9.a Antepecho arpado y dentellado. Alzado.
- Fig.9.b Silueta de hiladas en planta.
- Fig.9.c Disposición de ladrillos dentellados.
- Fig.9.d Disposición de ladrillos arpados.
- Fig.9.e Disposición conjunta.
Ver Martín Villa s/n.

LAMINA 0706

ALMENADOS, CRESTERIAS, ANTEPECHOS Y BALCONES
ANTEPECHOS DENTELLADOS Y ARPADOS

- Fig.1 Luis Montoto 3 y 5.
- Fig.2 Carretera de Cádiz s/n(2). (Fot.C.57.02)
- Fig.3 Carretera de Cádiz s/n(2). (Fot.C.57.14)
- Fig.4 Antepecho arpado en columnilla.
Ver Martín Villa s/n.
- Fig.5 Alameda de Hércules 52.
- Fig.6 Tarifa 4.

LAMINA 0707

ALMENADOS, CRESTERIAS, ANTEPECHOS Y BALCONES
BALCONES DENTELLADOS

- Fig.1 Carretera de Cádiz s/n(2). (Fot.C.57.09)
- Fig.2 Carretera de Cádiz s/n(2). (Fot.C.57.12)
- Fig.3 Carretera de Cádiz s/n(2). (Fot.C.57.10)
- Fig.4 Carretera de Cádiz s/n(2). (Fot.C.56.08)
- Fig.5 San Miguel 20 y 22.

LAMINA 0708

ALMENADOS, CRESTERIAS, ANTEPECHOS Y BALCONES
BALCONES SINGULARES

- Fig.1 Tarifa 4.
- Fig.2 Orfila 7.
- Fig.3 Campana 6.
- Fig.4 Cuna 26.

SERIE TEORICA

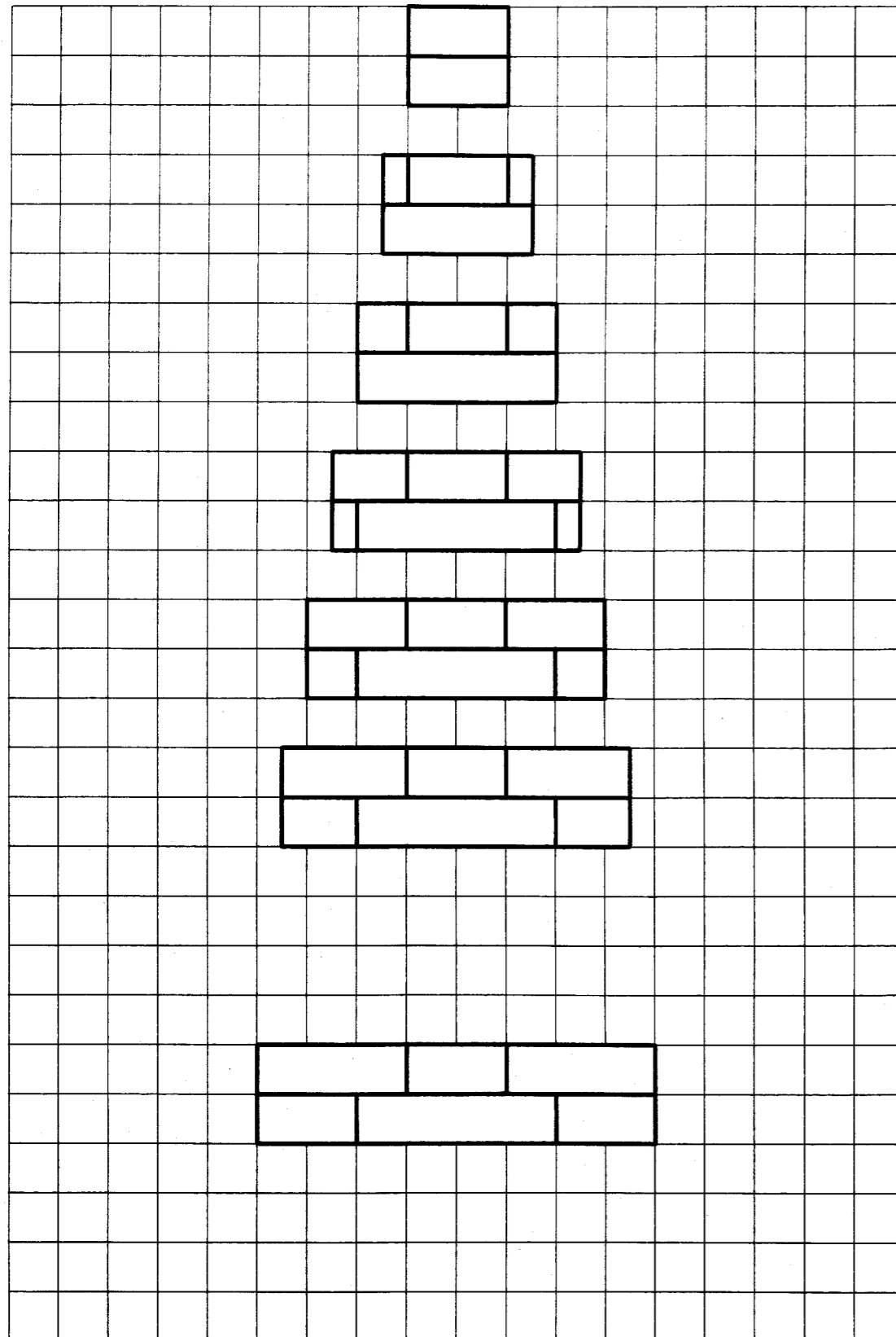

SERIE REAL

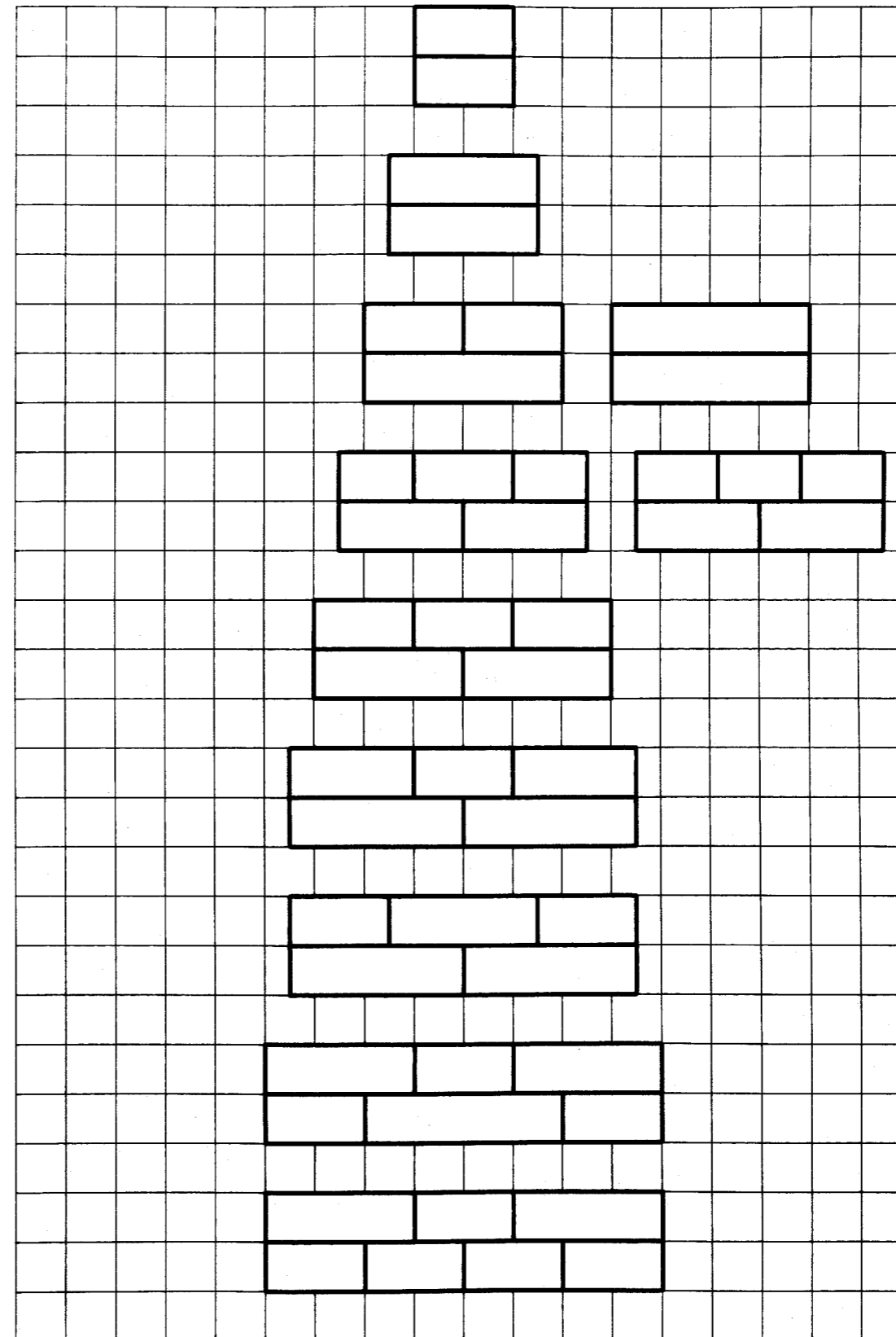

01	$L_s = T$
	$L_i = T$
	$L = 2m$
02	$L_s = T + 2A$
	$L_i = B$
	$2m < L < 4m$
03	$L_s = T + 2A$
	$L_i = S$
	$L = 4m$
04	$L_s = T + 2A$
	$L_i = S + 2B$
	$4m < L < 6m$
05	$L_s = T + 2T = 3T$
	$L_i = S + 2B$
	$L = 6m$
06	$L_s = T + 2A$
	$L_i = S + B$
	$6m < L < 8m$
07	$L_s = T + 2A$
	$L_i = S + 2T$
	$L = 8m$

SERIE TEORICA

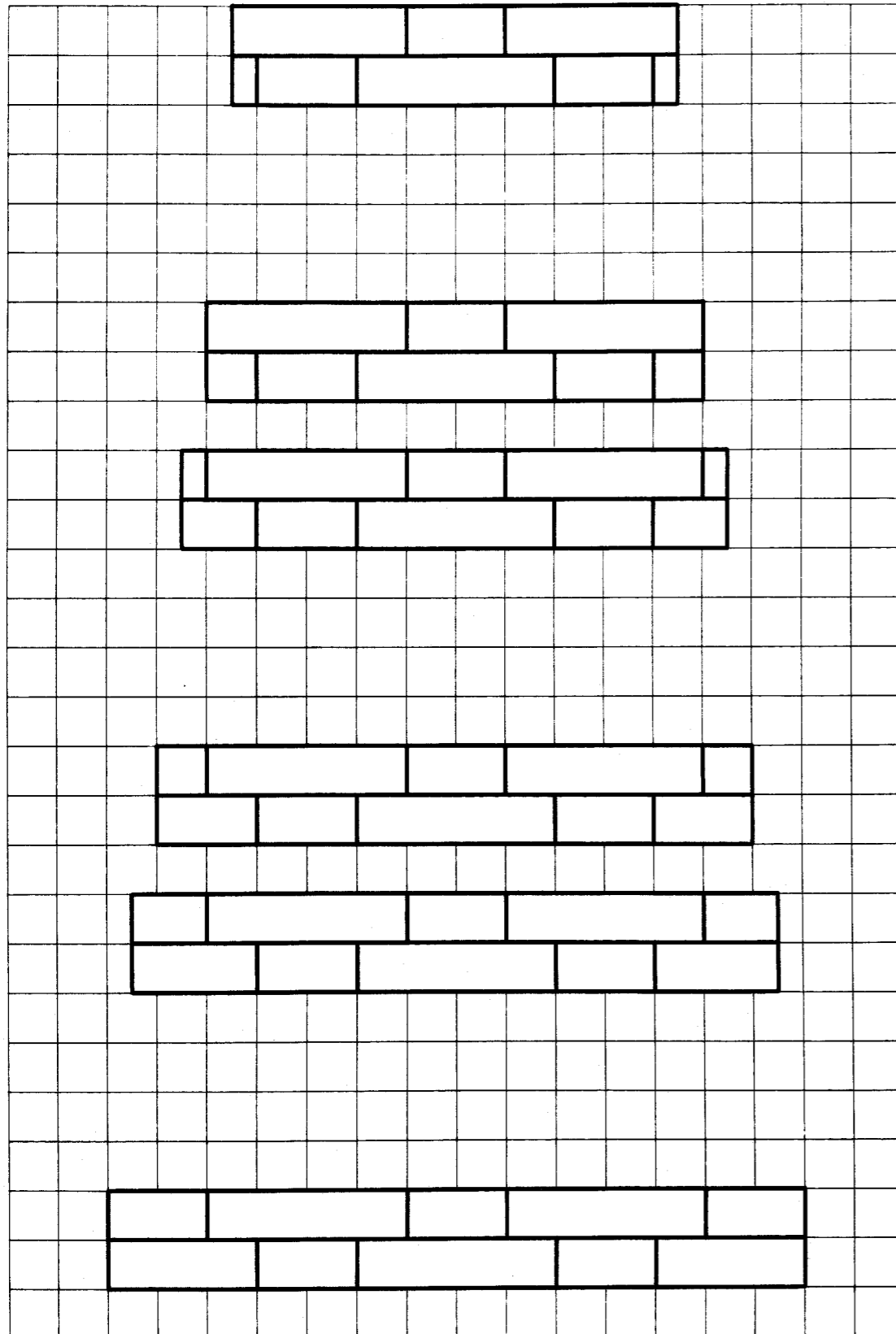

SERIE REAL

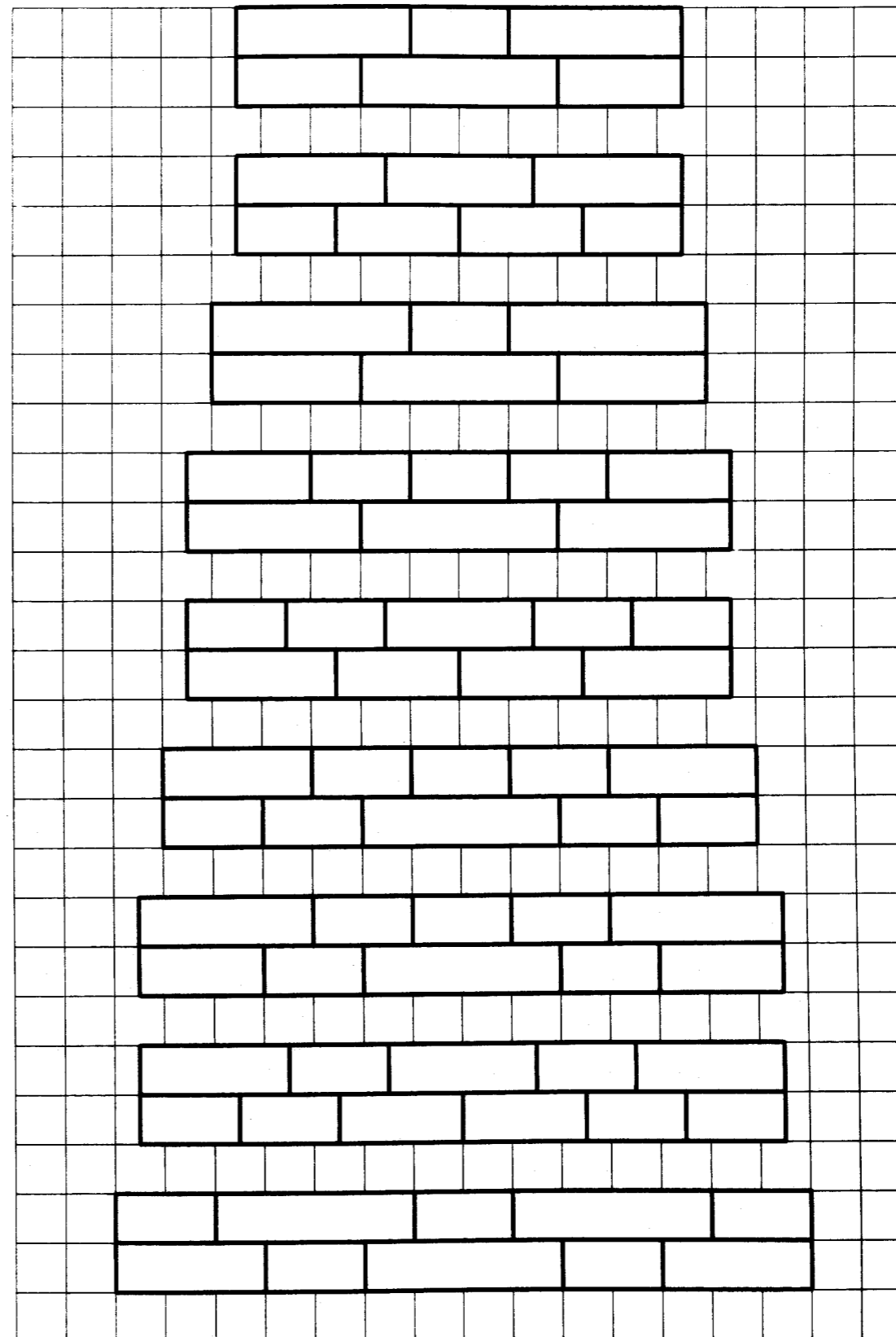

08	$L_s = T + 2A$
	$L_i = S + 2T + 2B$
	$8m < L < 10m$
09	$L_s = T + 2S$
	$L_i = S + 2T + 2B$
	$L = 10m$
10	$L_s = T + 2S + 2A$
	$L_i = S + 2T + 2B$
	$10n < L < 12m$
11	$L_s = T + 2S + 2A$
	$L_i = S + 2T + 2T$
	$L = 12m$
12	$L_s = T + 2S + 2A$
	$L_i = S + 2T + 2B$
	$12m < L < 14m$
13	$L_s = T + 2S + 2T$
	$L_i = S + 2T + 2B$
	$L = 14m$

LAMINA 0103

REPLANTEO DE PAÑOS

REPLANTEO DE PAÑOS 3 Y CASOS PARTICULARES

SERIE TEORICA

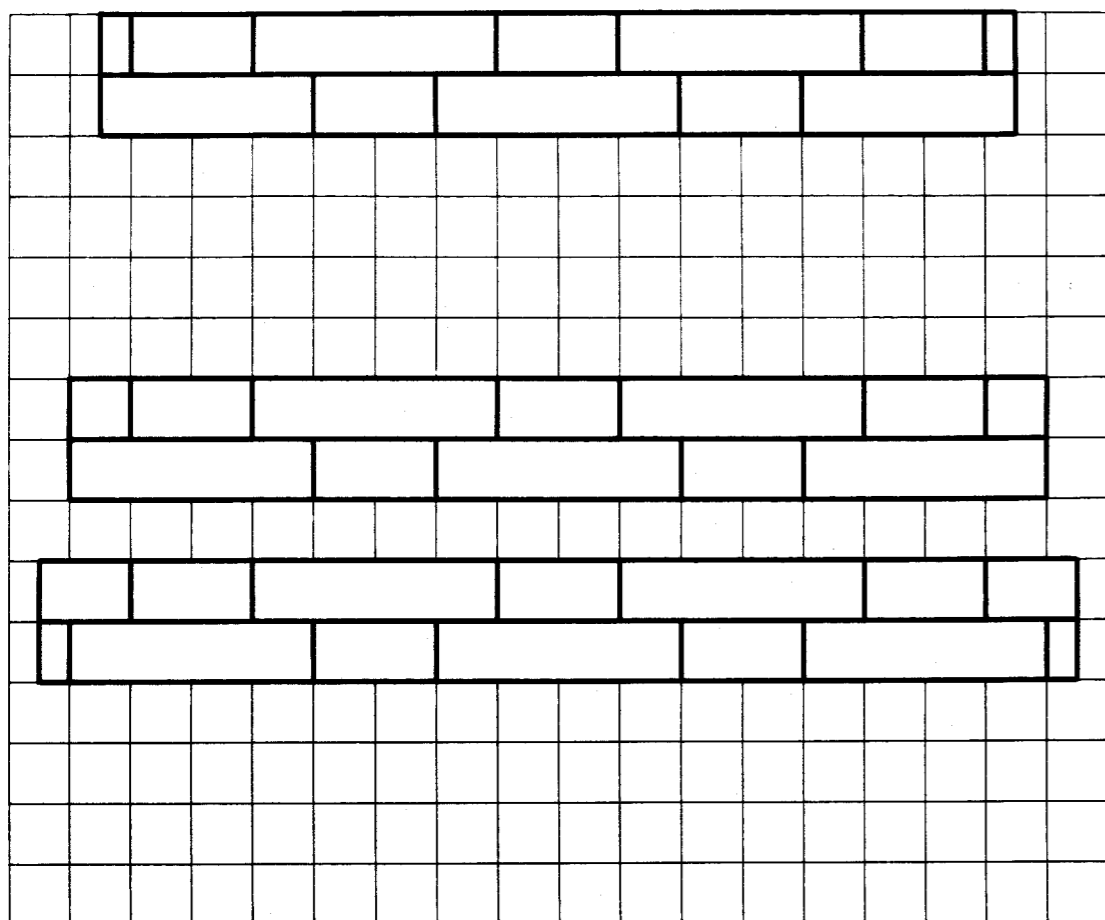

SERIE REAL

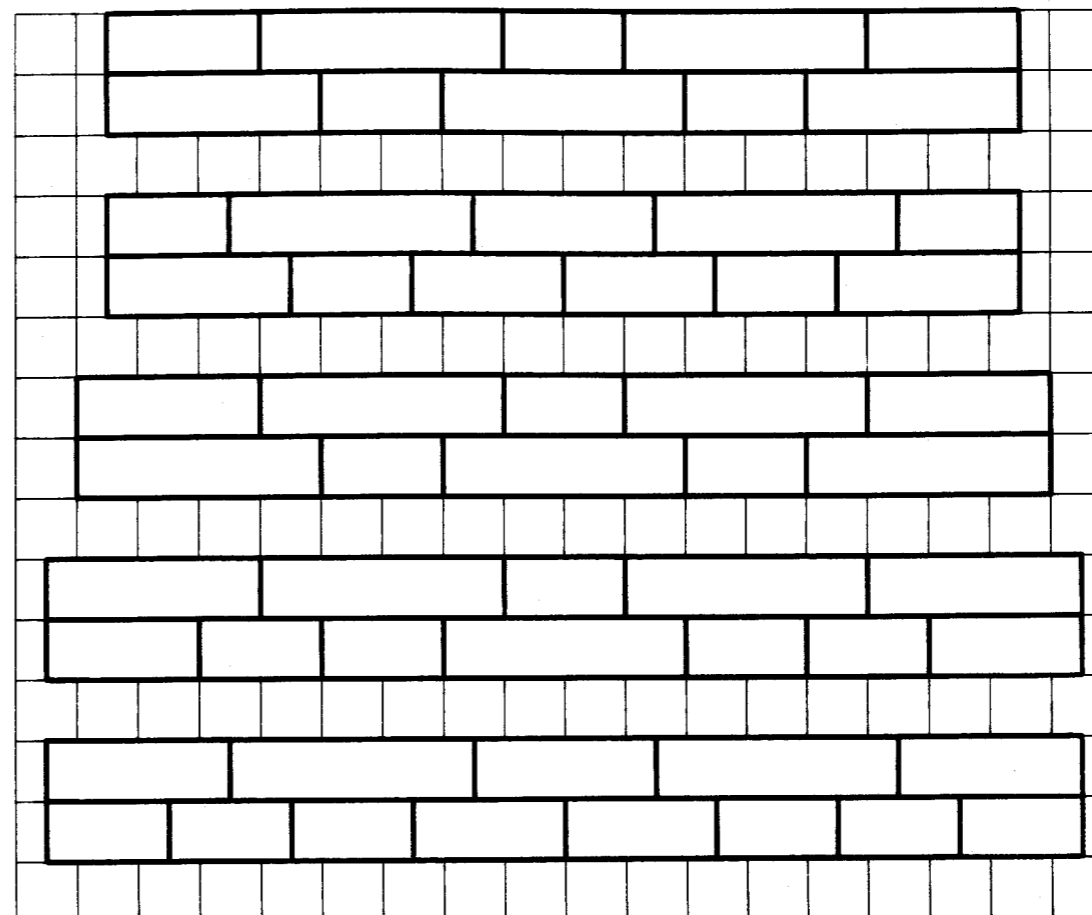

14	$L_s = T + 2S + 2T + 2A$
	$L_i = S + 2T + 2B$
	$14m < L < 16m$
15	$L_s = T + 2S + 2T + 2A$
	$L_i = S + 2T + 2S$
	$L = 16m$
16	$L_s = T + 2S + 2T + 2A$
	$L_i = S + 2T + 2S + 2B$
	$16m < L < 18m$

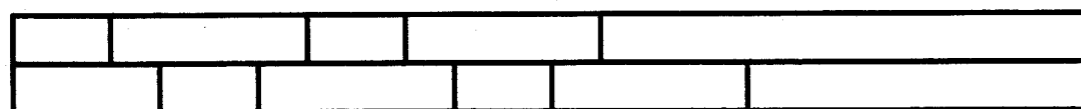

Fig. 1

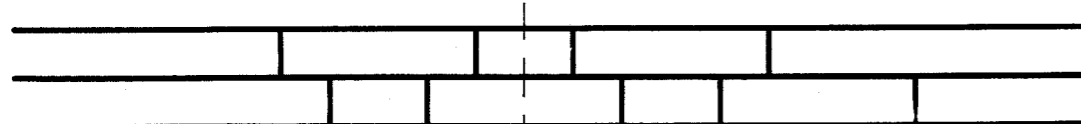

Fig. 2

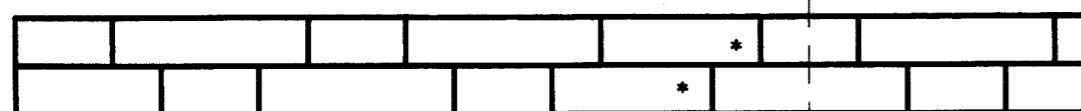

Fig. 3.a

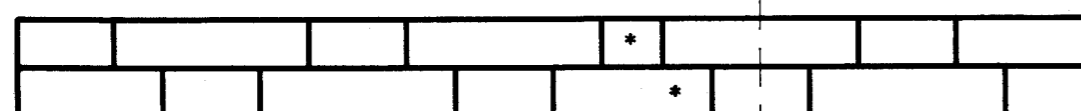

Fig. 3.b

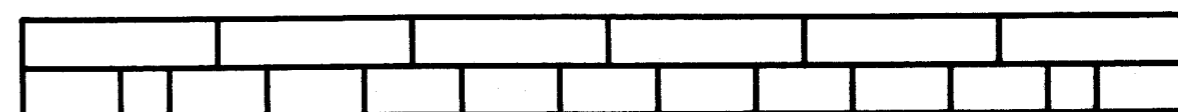
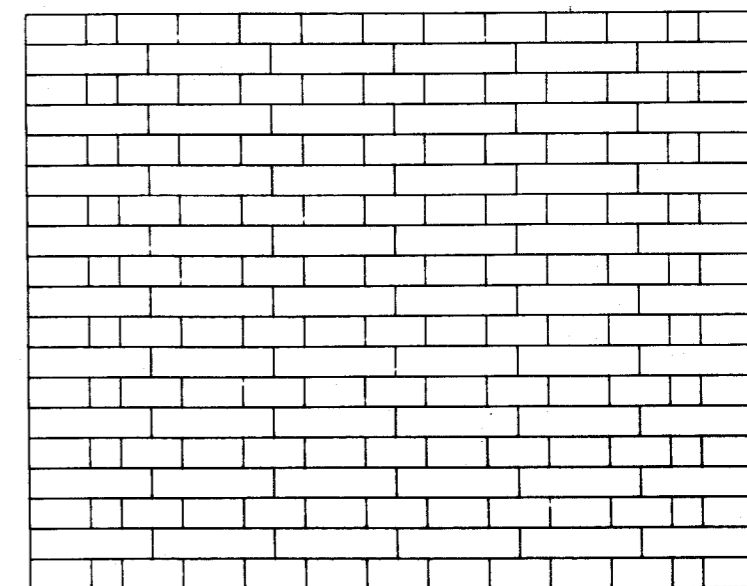

Fig. 4

LAMINA 0201
ORNAMENTACIONES SUPERFICIALES
TIPOS DE SUPERFICIES ORNAMENTABLES

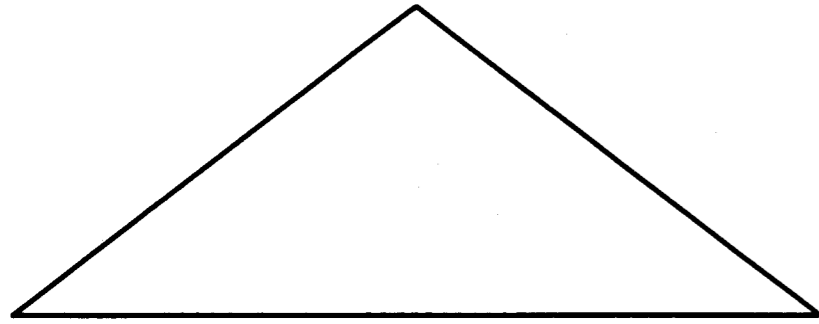

Fig. 1

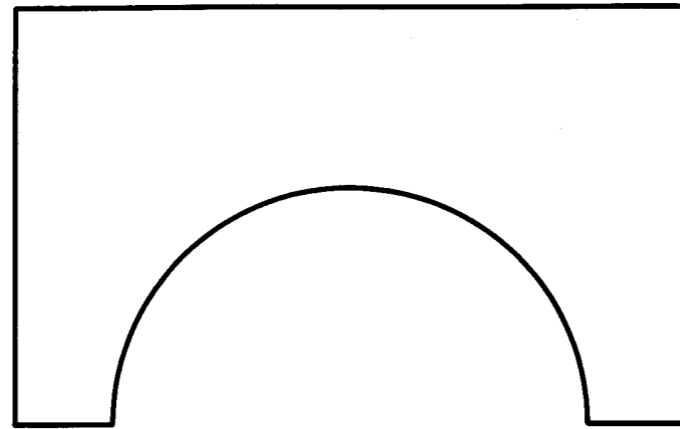

Fig. 4

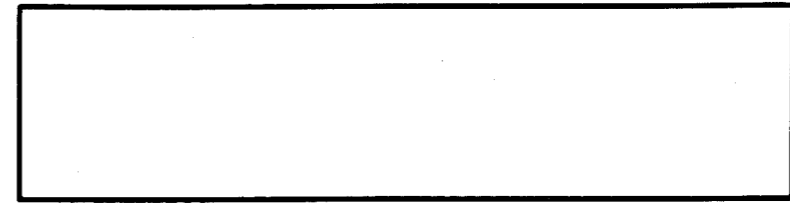

Fig. 7

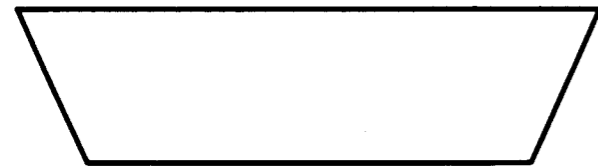

Fig. 2

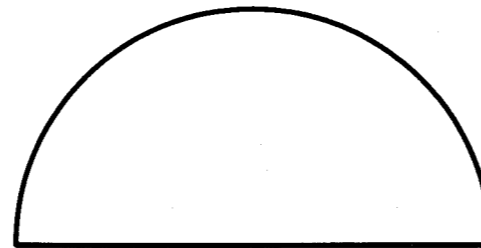

Fig. 5

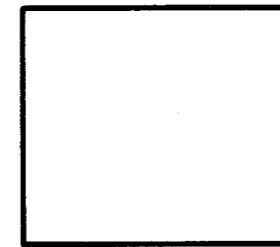

Fig. 8



Fig. 10

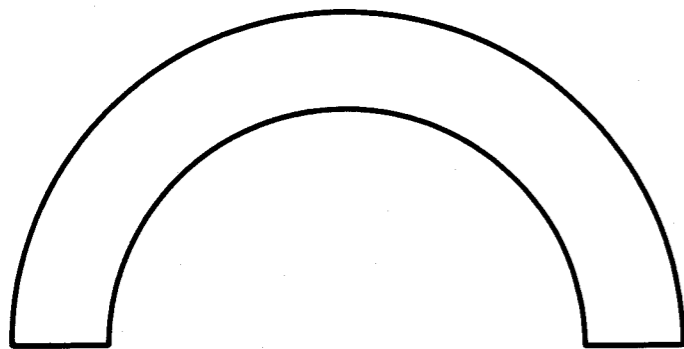

Fig. 3

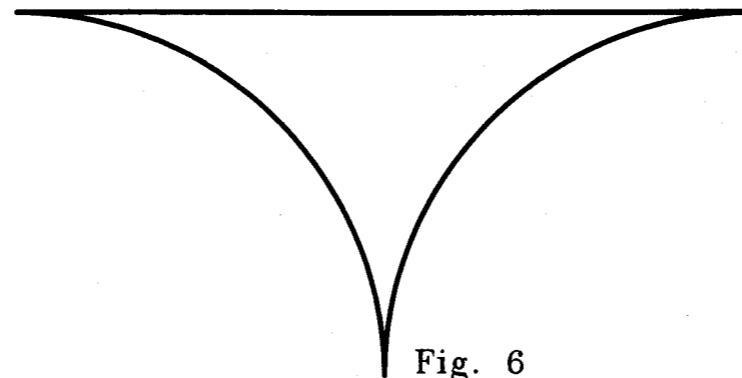

Fig. 6

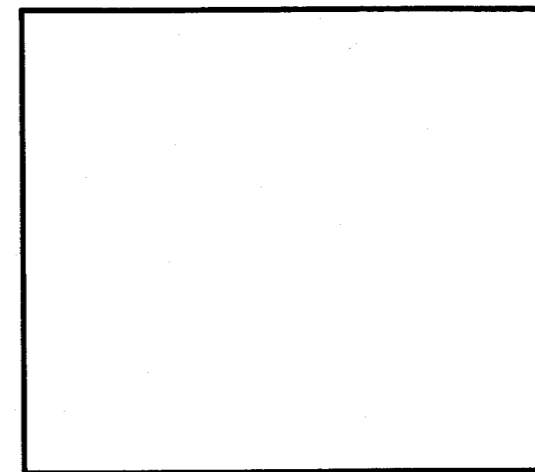

Fig. 9

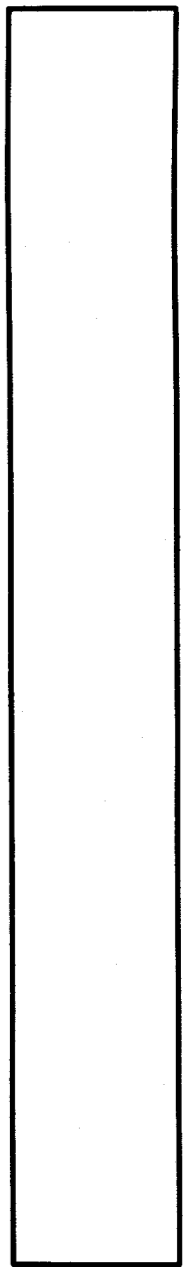

Fig. 11

LAMINA 0202
 ORNAMENTACIONES SUPERFICIALES
 PILASTRAS

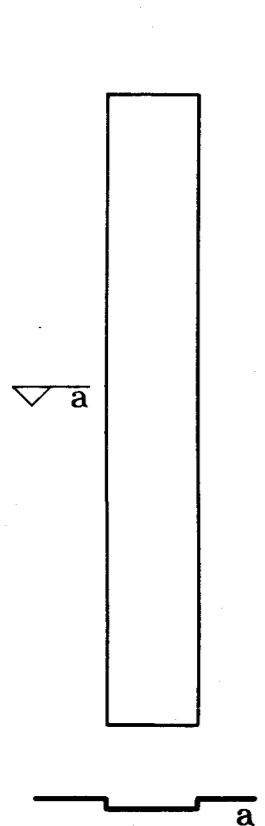

Fig. 1

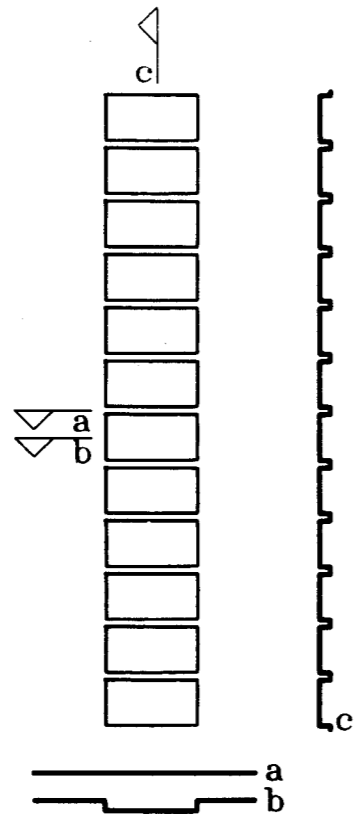

Fig. 2

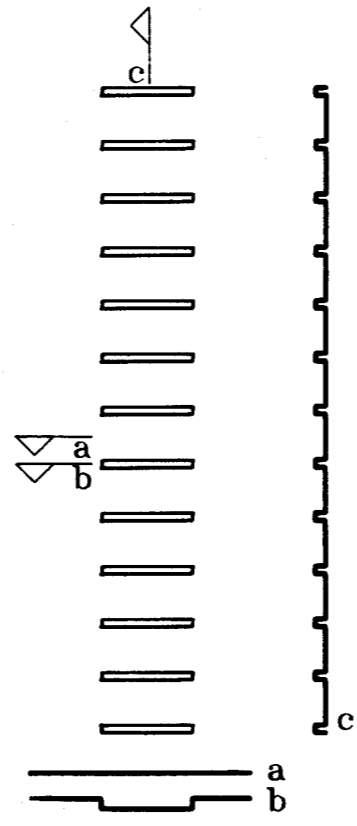

Fig. 3

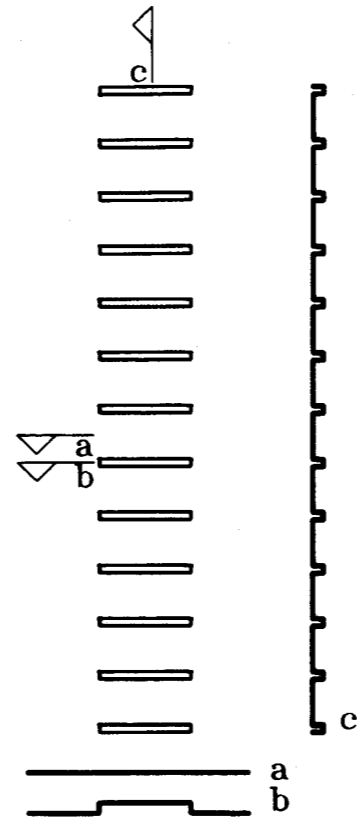

Fig. 4

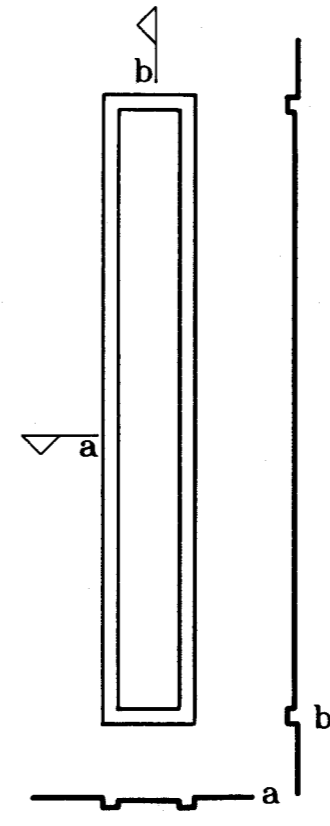

Fig. 5

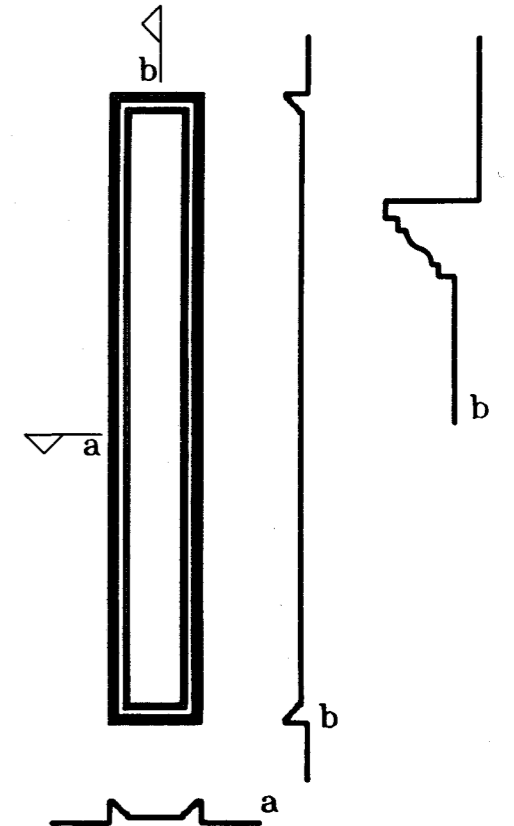

Fig. 6

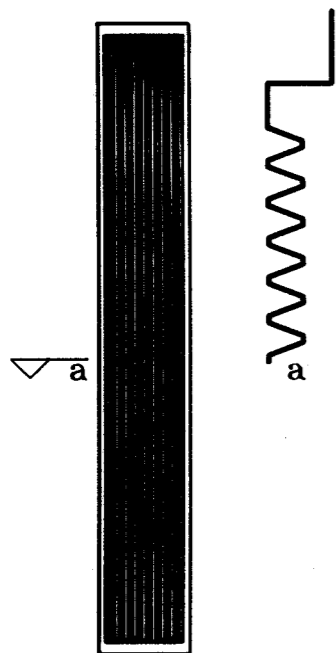

Fig. 7

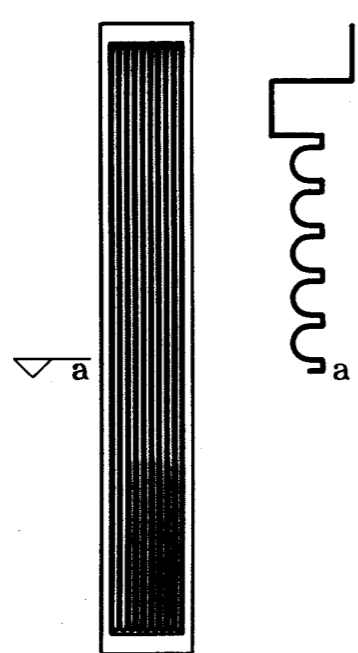

Fig. 8

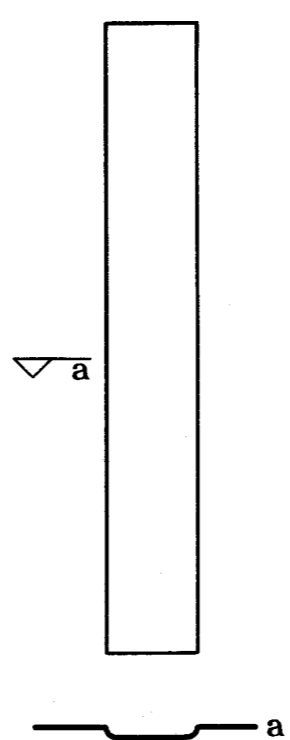

Fig. 9

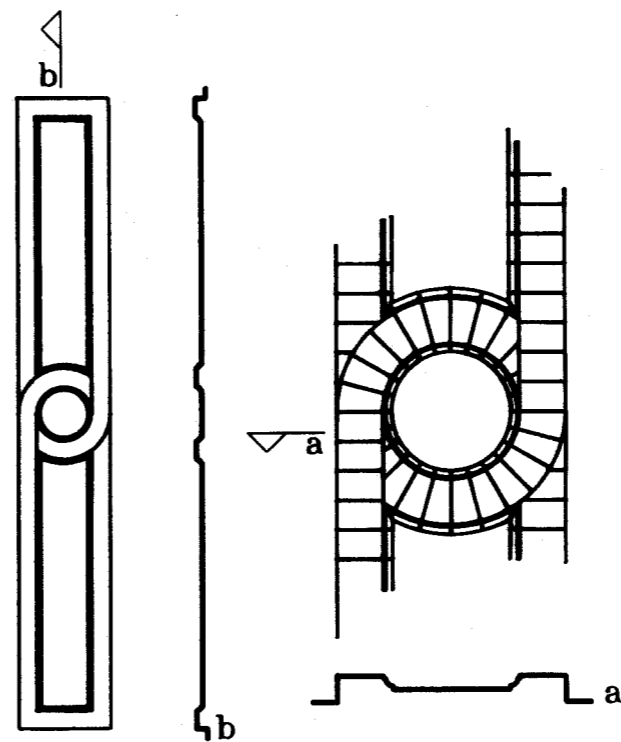

Fig. 10

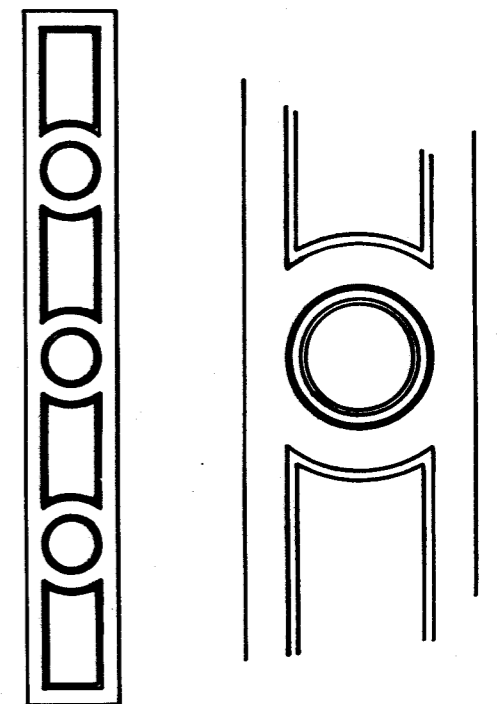

Fig. 11

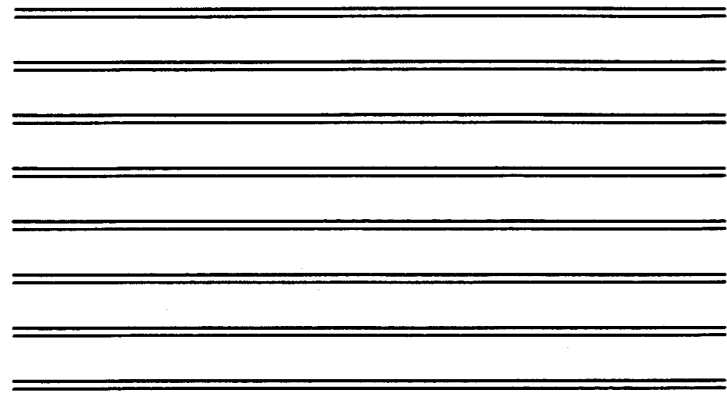

Fig. 1

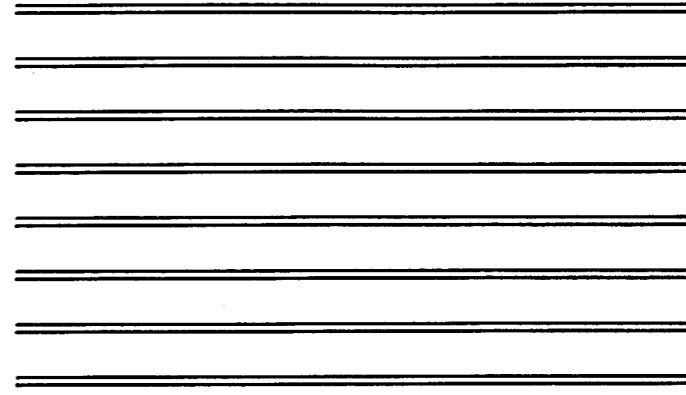

Fig. 2

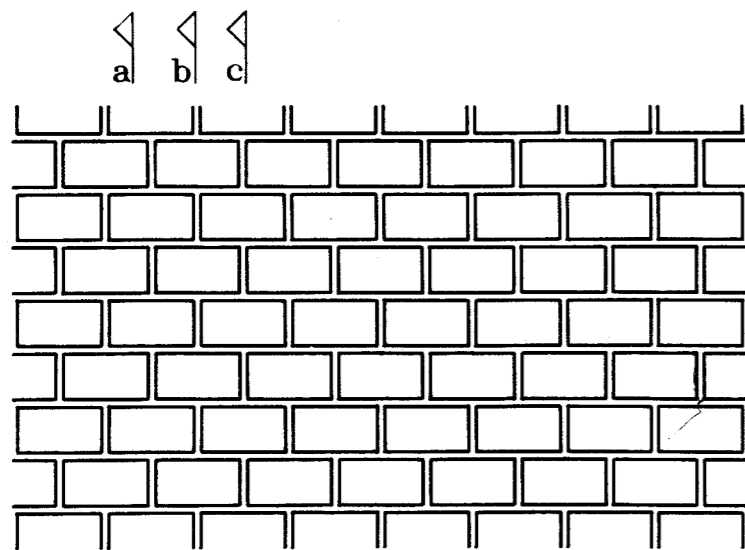

Fig. 3

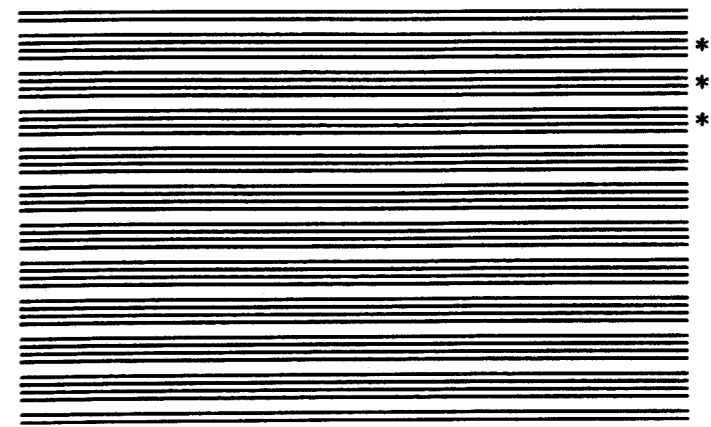

Fig. 4



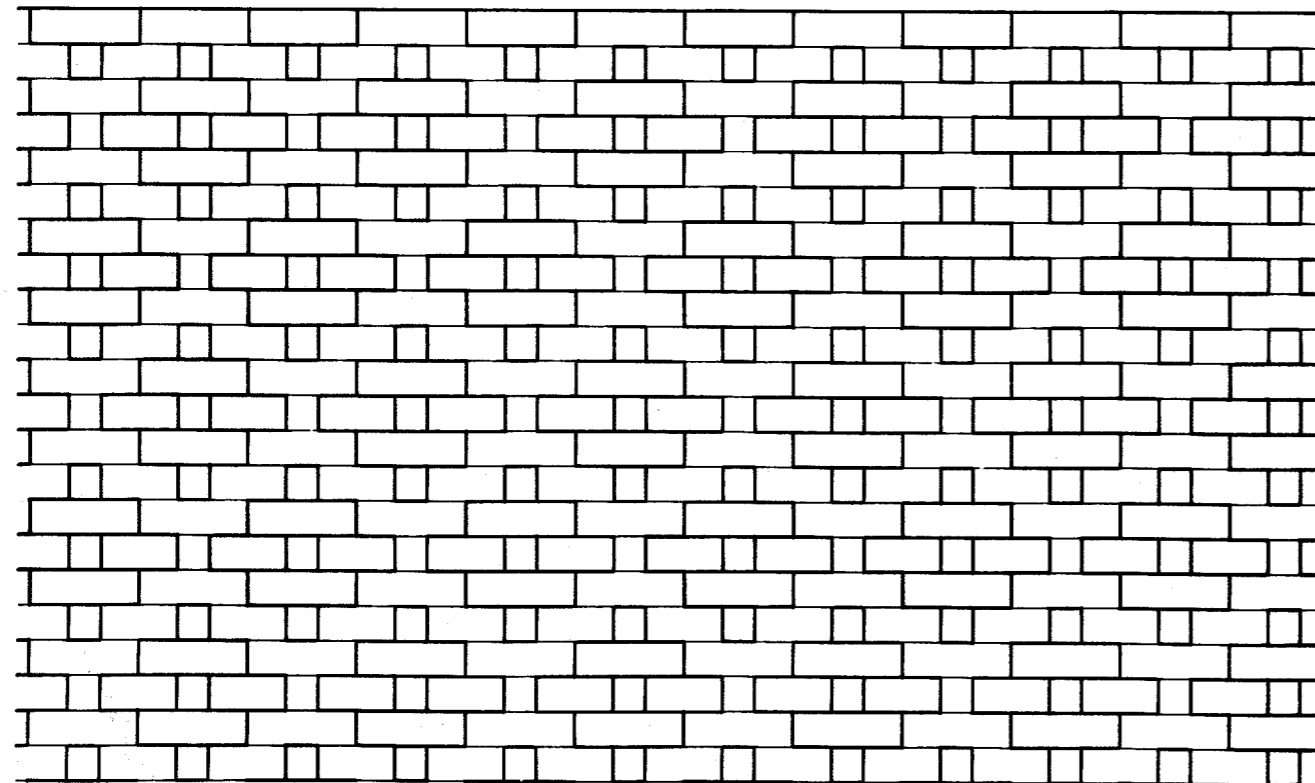
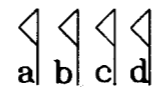
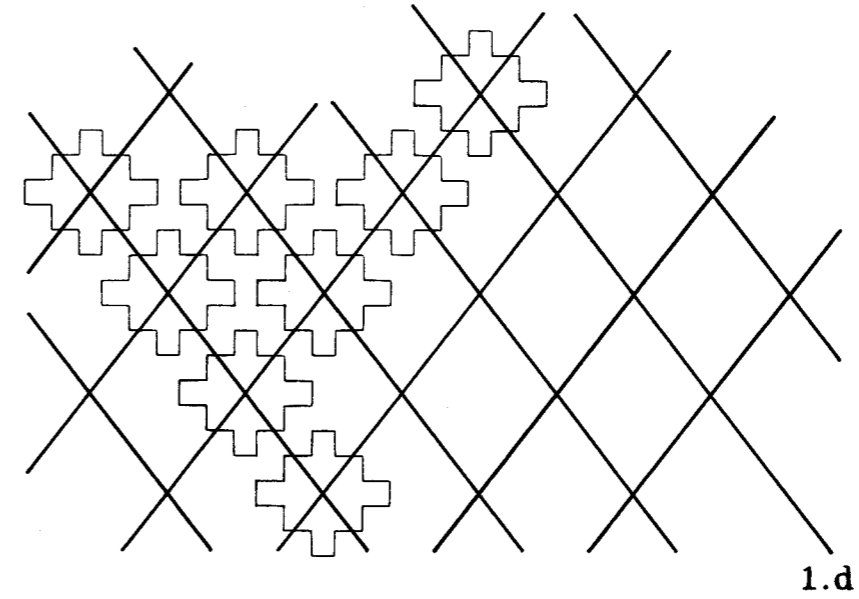
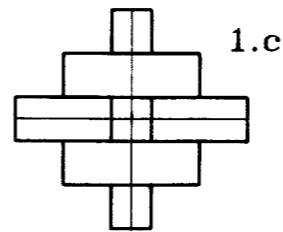
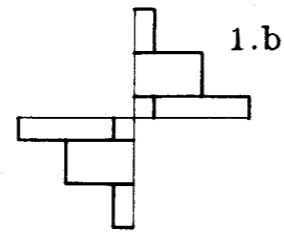
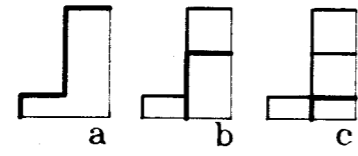
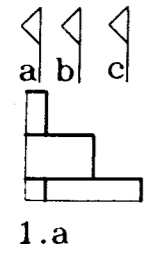
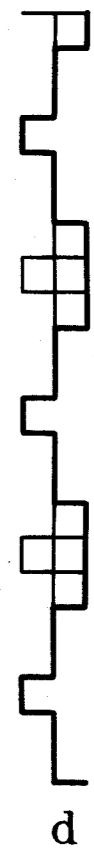
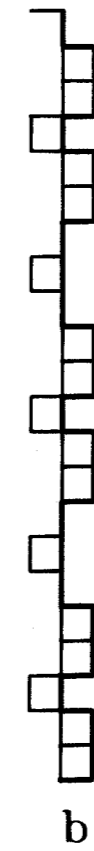
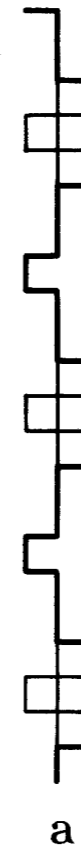
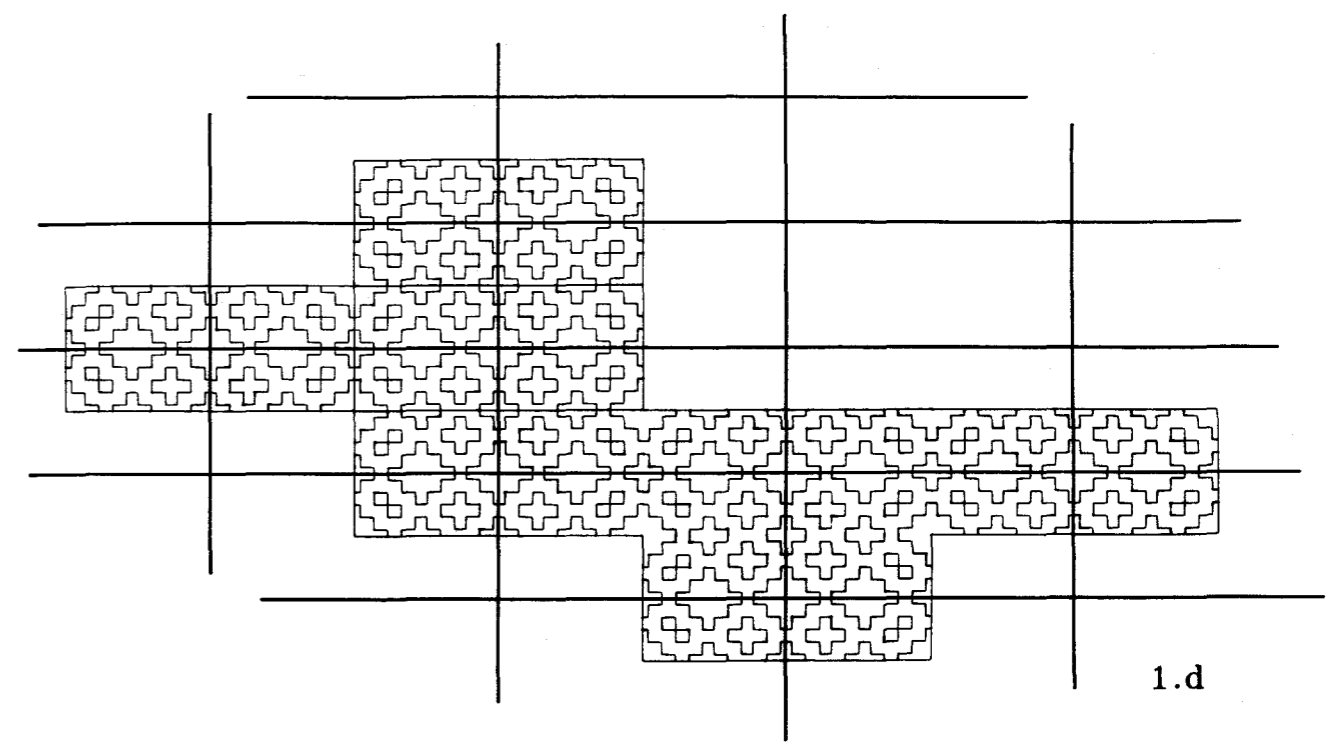
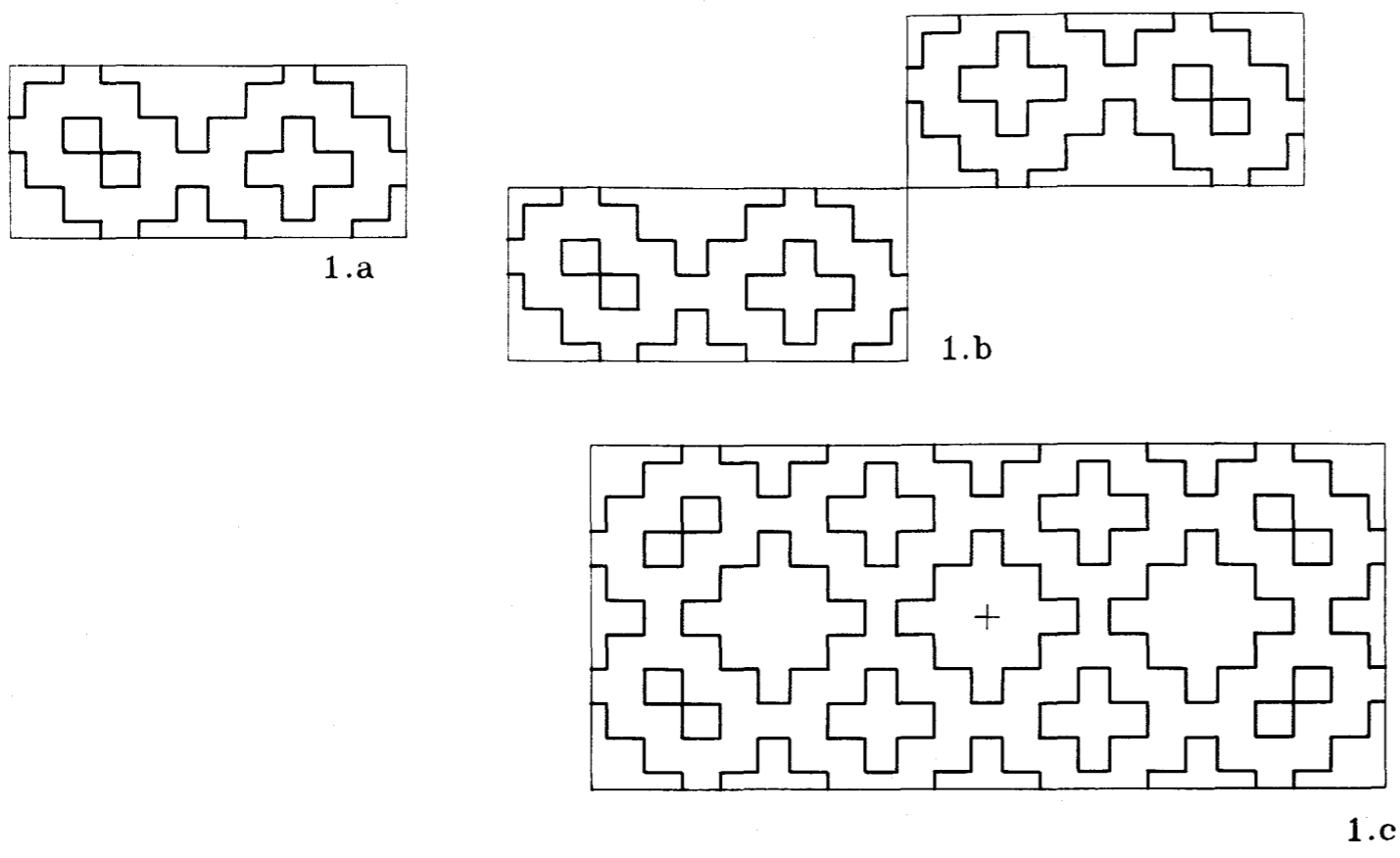

Fig. 1





a b c d e f e d g d e f

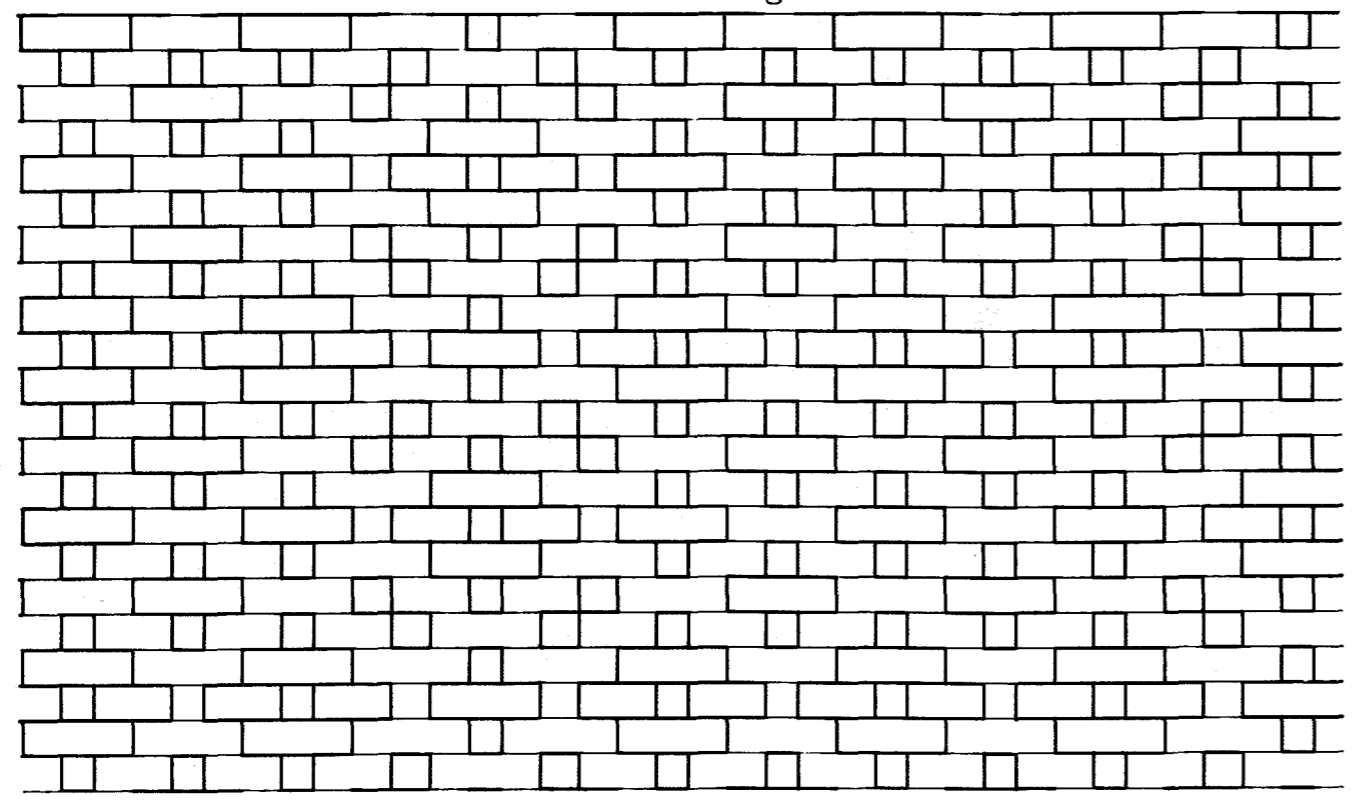
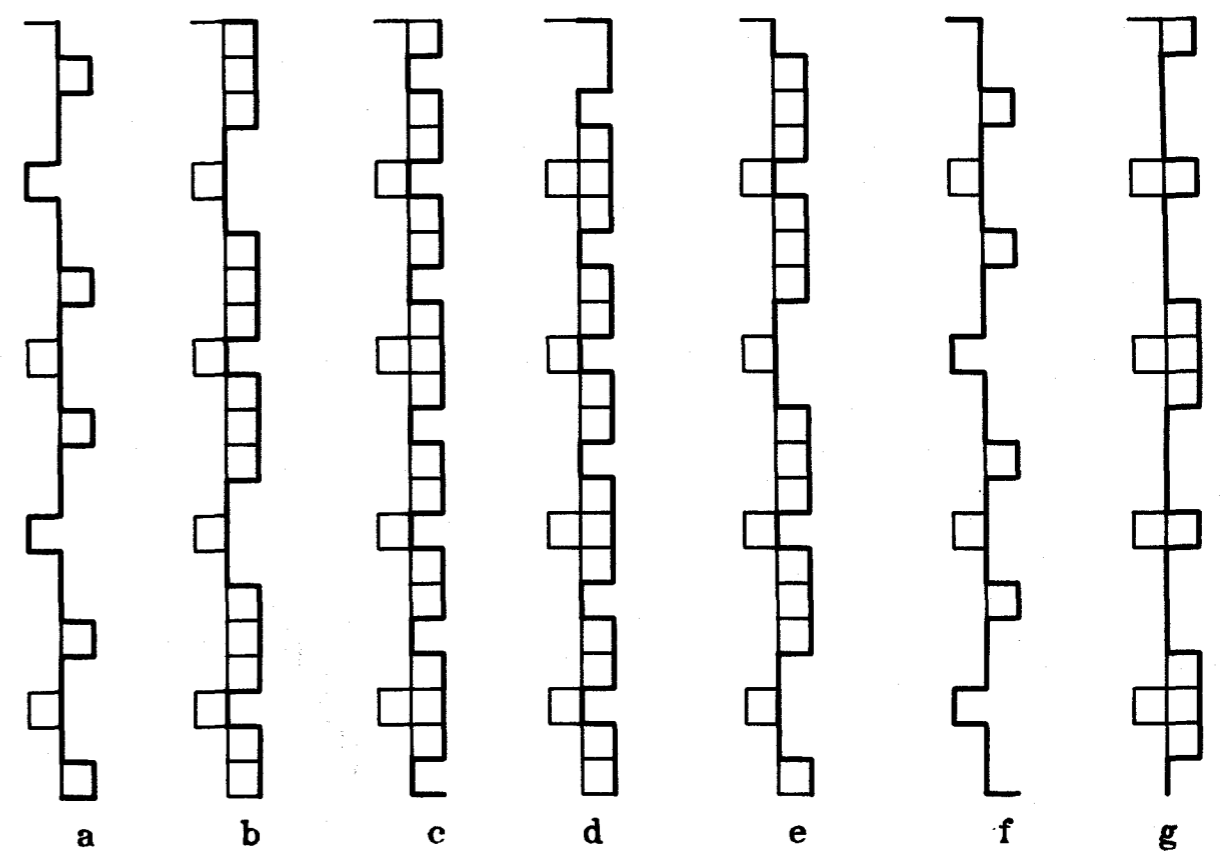
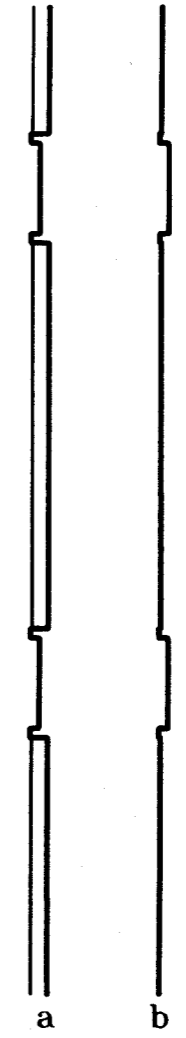
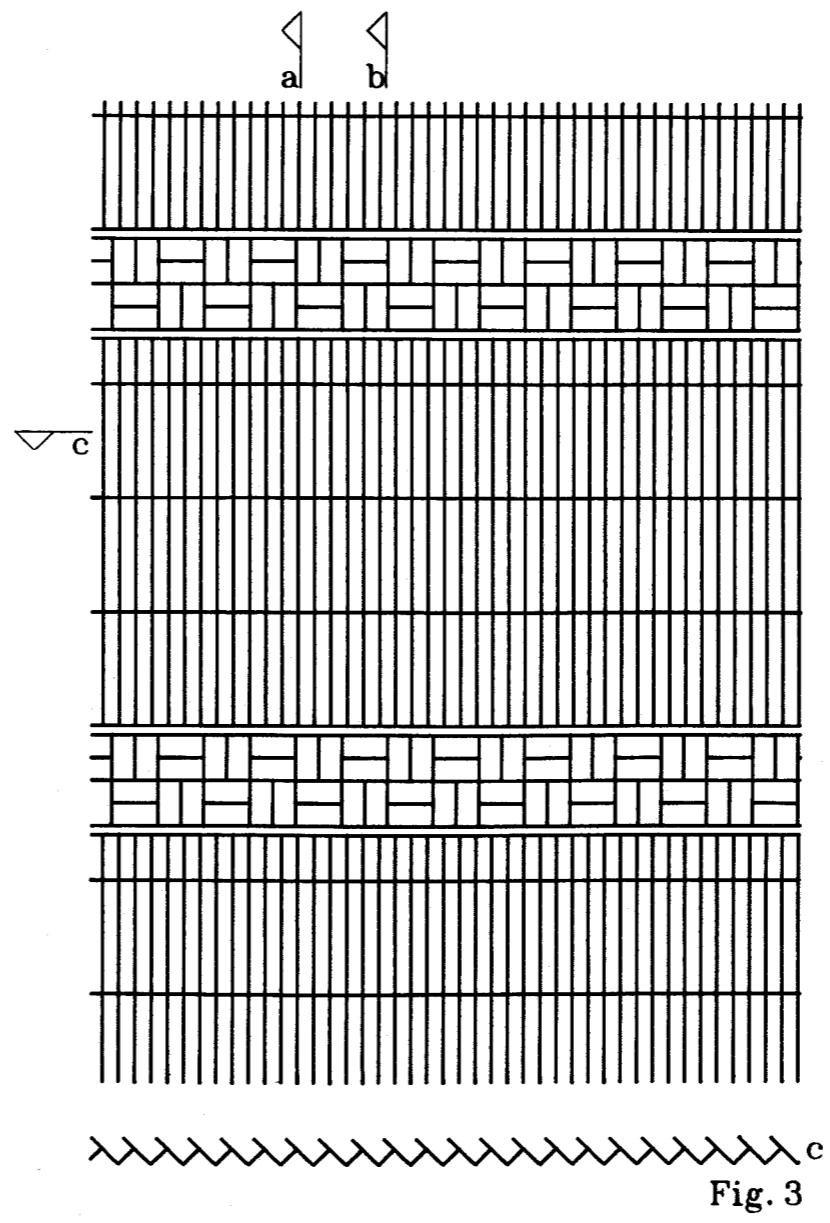
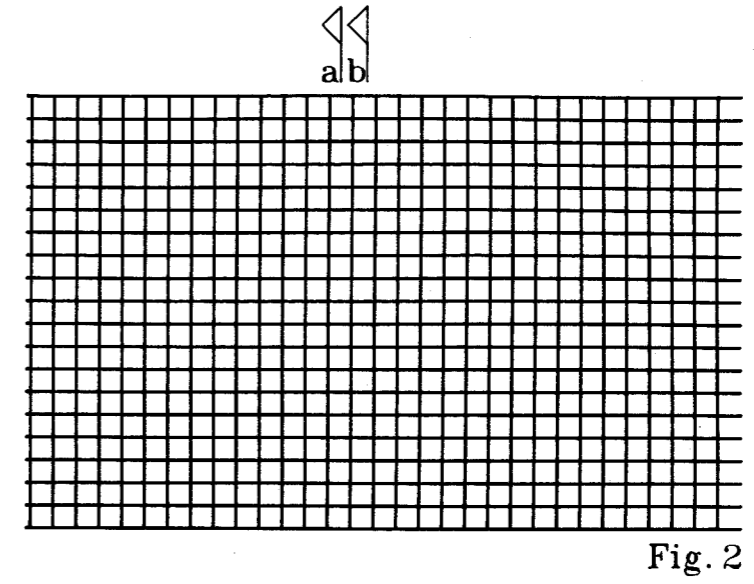
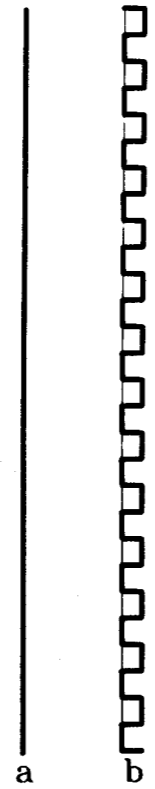
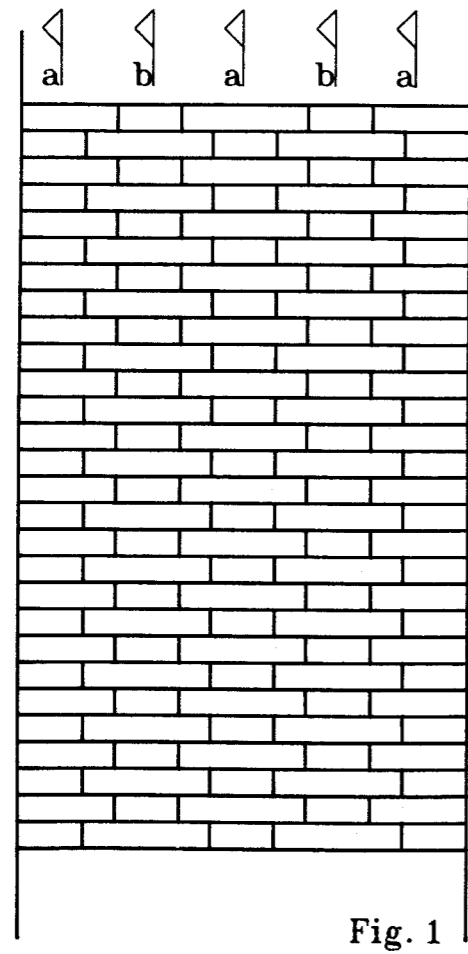

Fig. 1



LAMINA 0206
 ORNAMENTACIONES SUPERFICIALES
 MOTIVOS COMBINADOS



LAMINA 0207
ORNAMENTACIONES SUPERFICIALES
ESGRAFIADOS, ESTUDIO TIPO

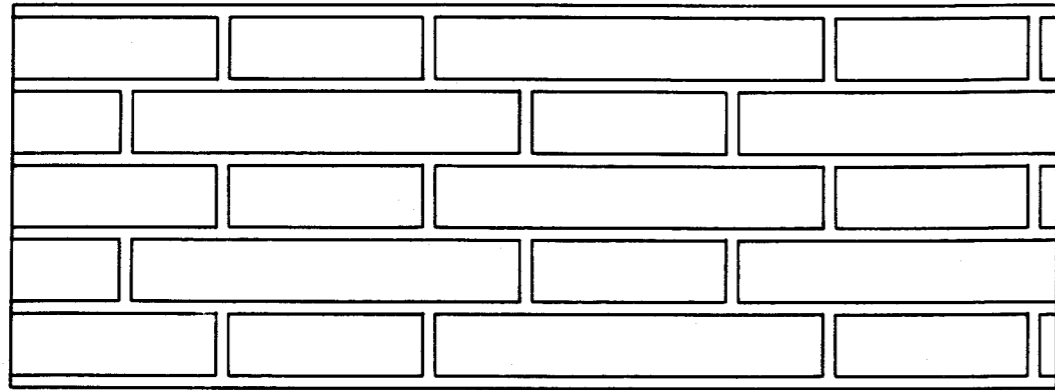

Fig. 1

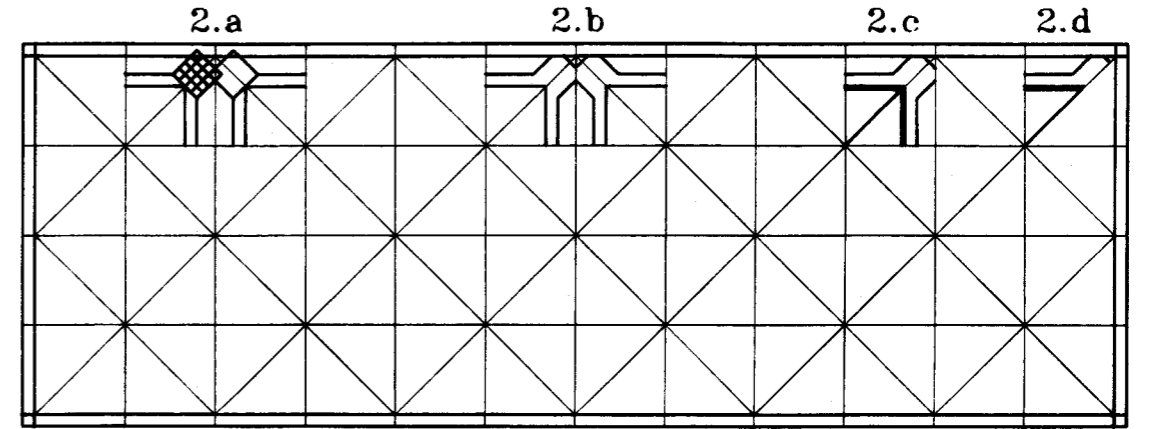

Fig. 2

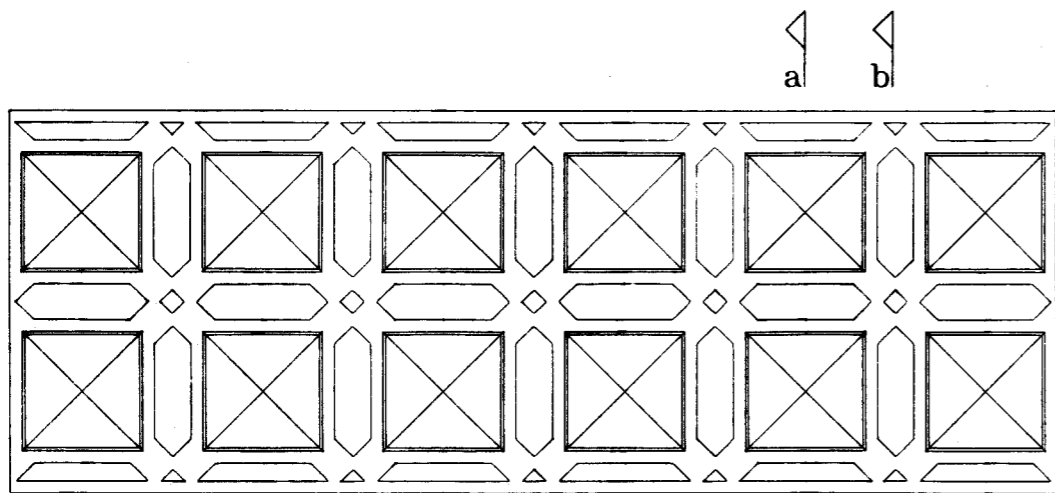

Fig. 3

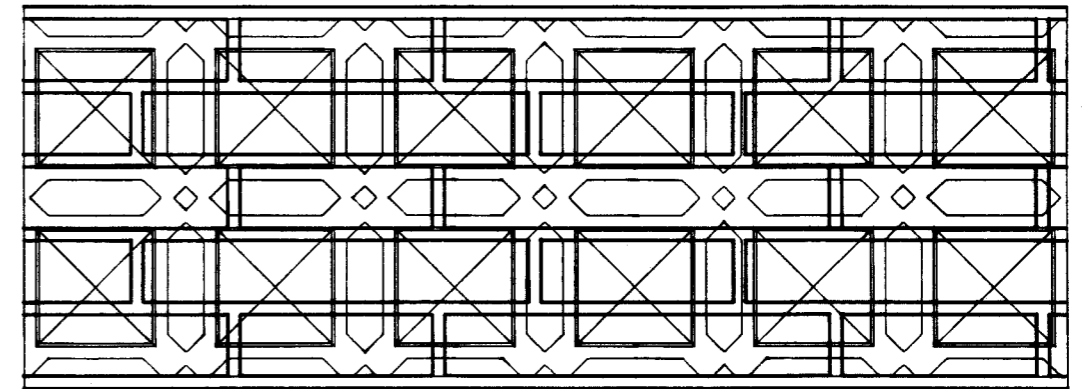
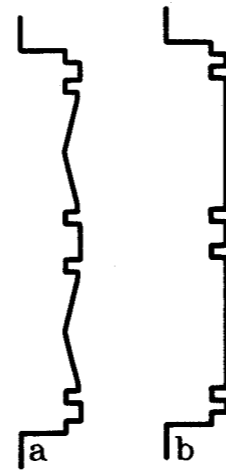

Fig. 4

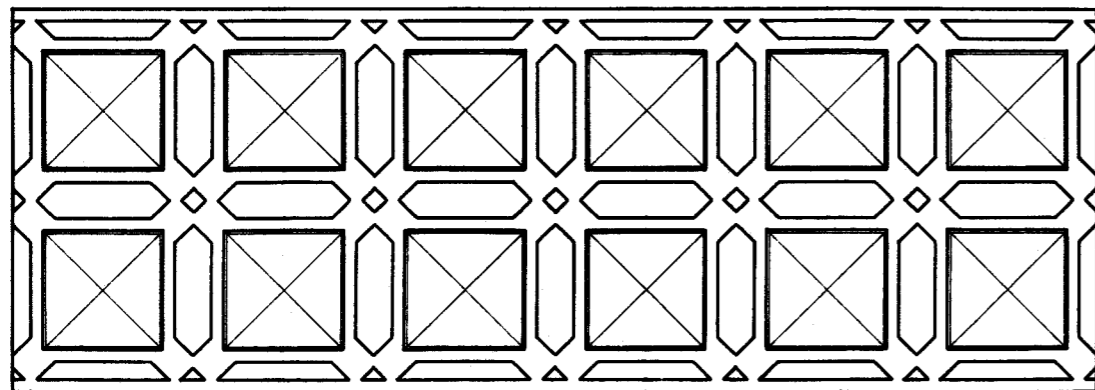

Fig. 5

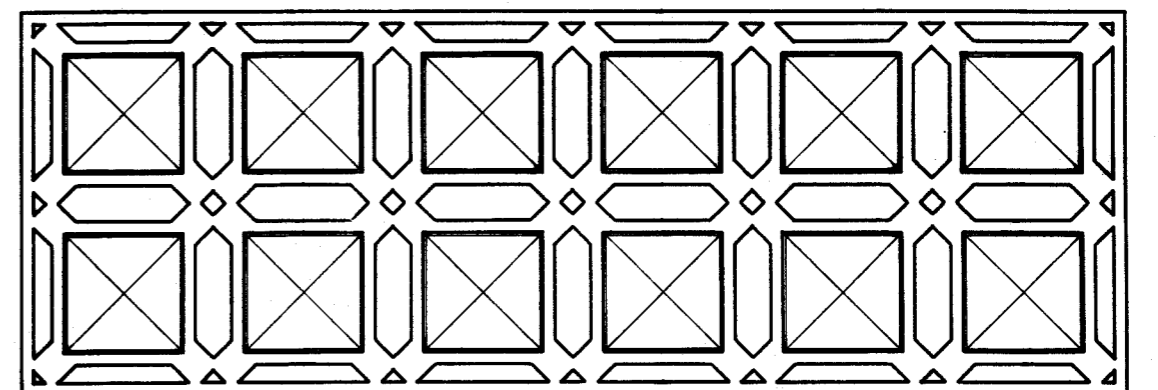

Fig. 6

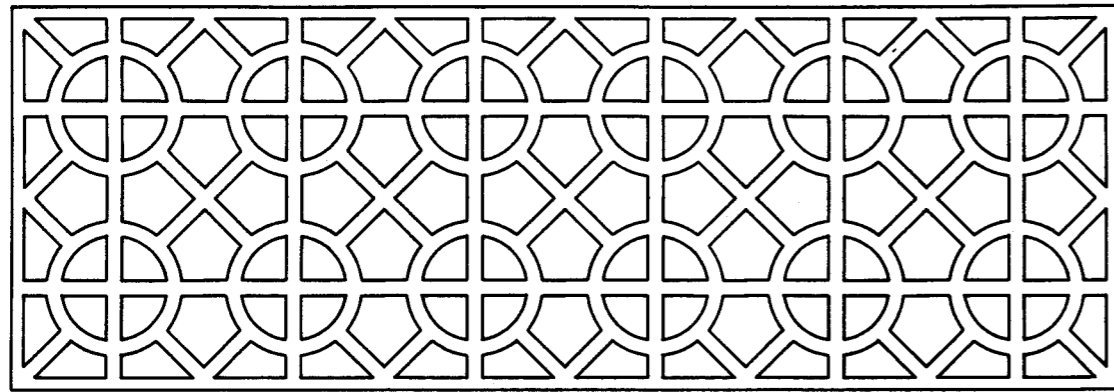

Fig. 1

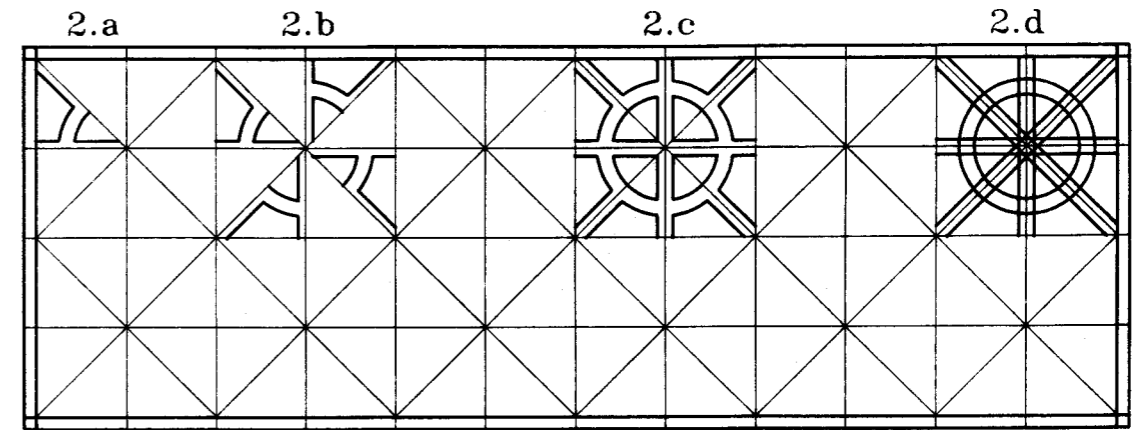

Fig. 2

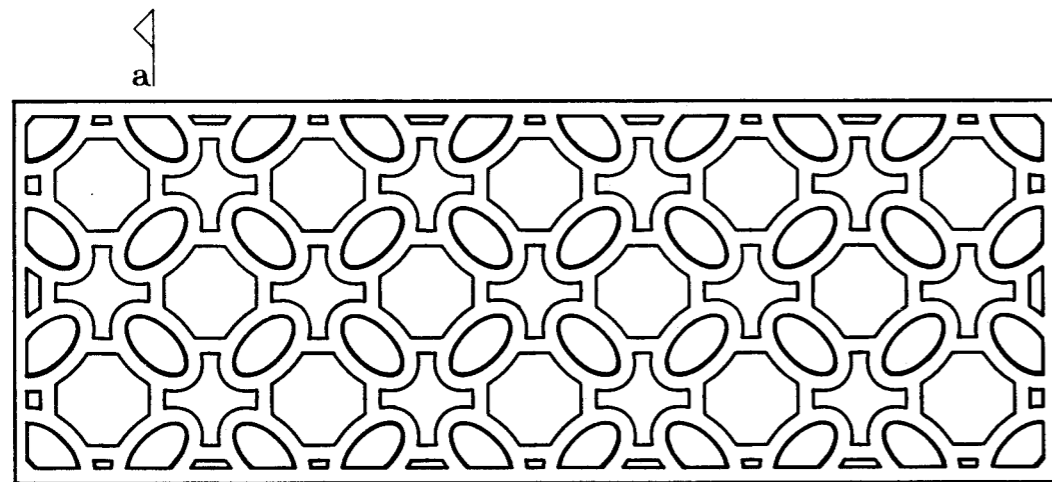

Fig. 3

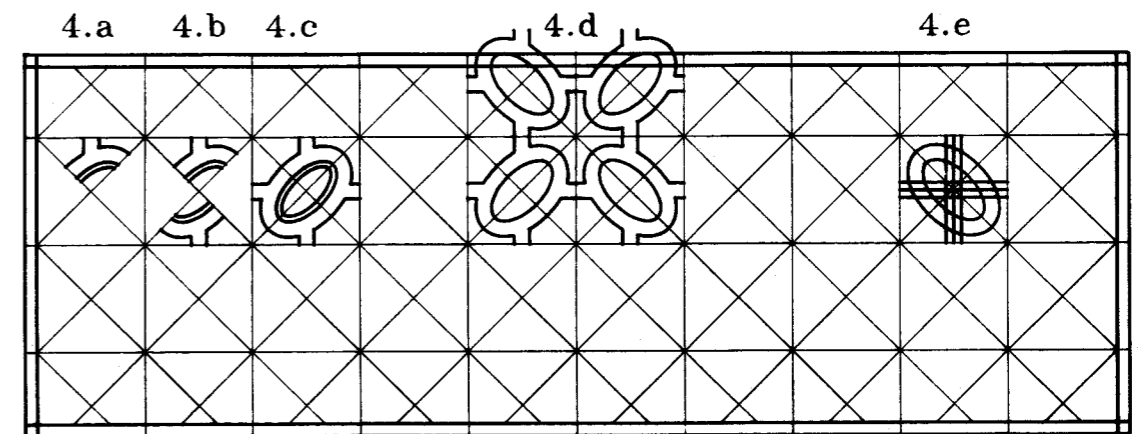

Fig. 4

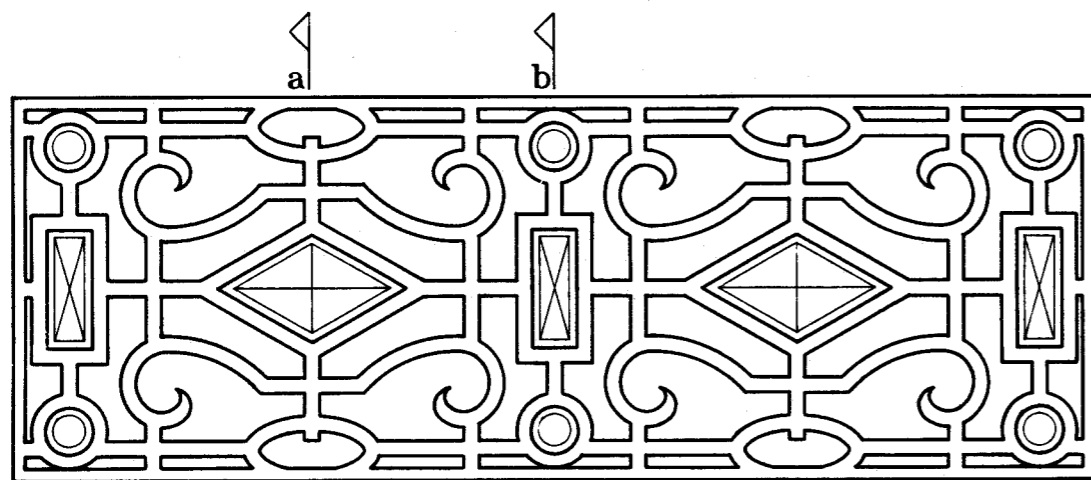

Fig. 5

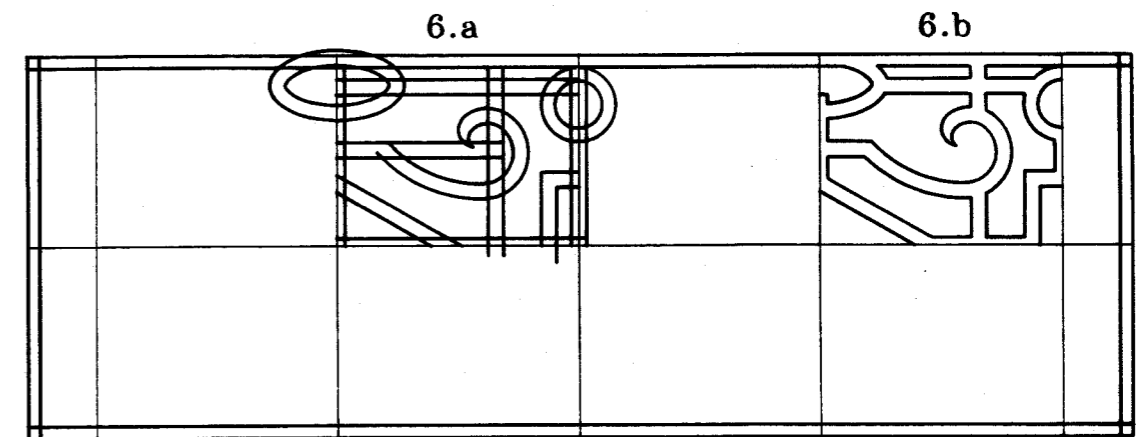
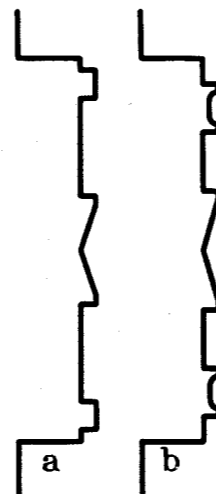

Fig. 6

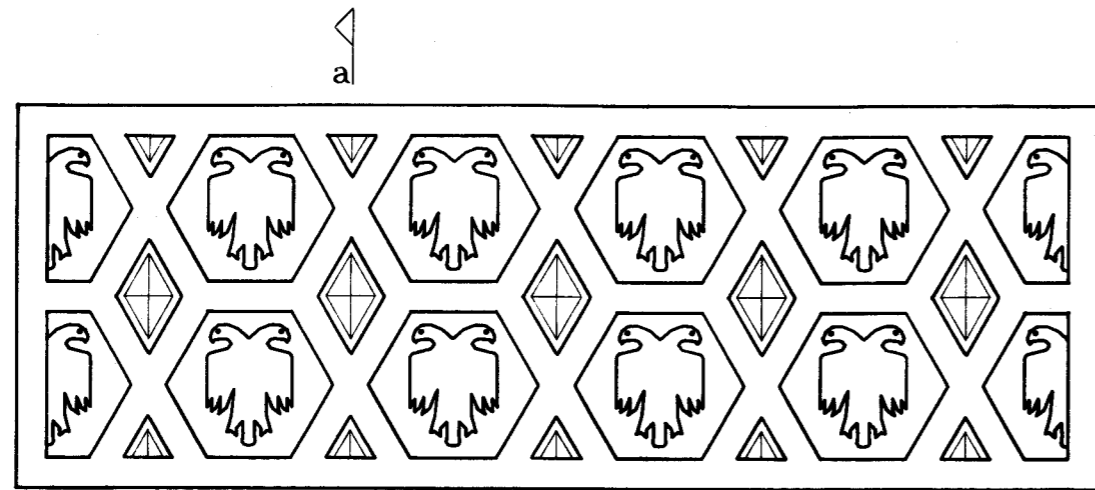

Fig. 7

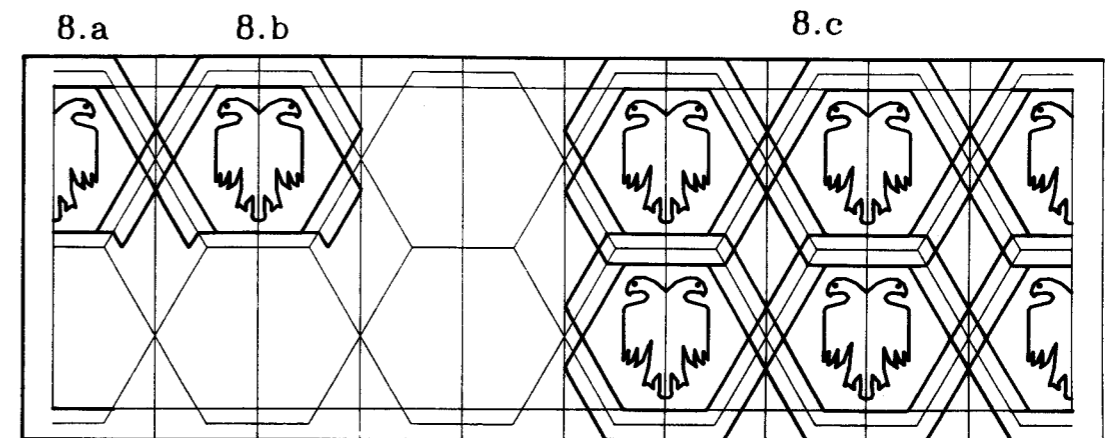

Fig. 8

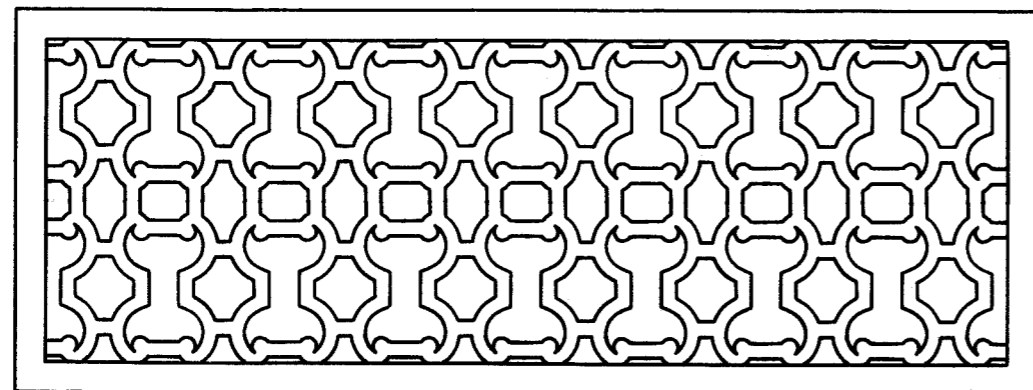

Fig. 9

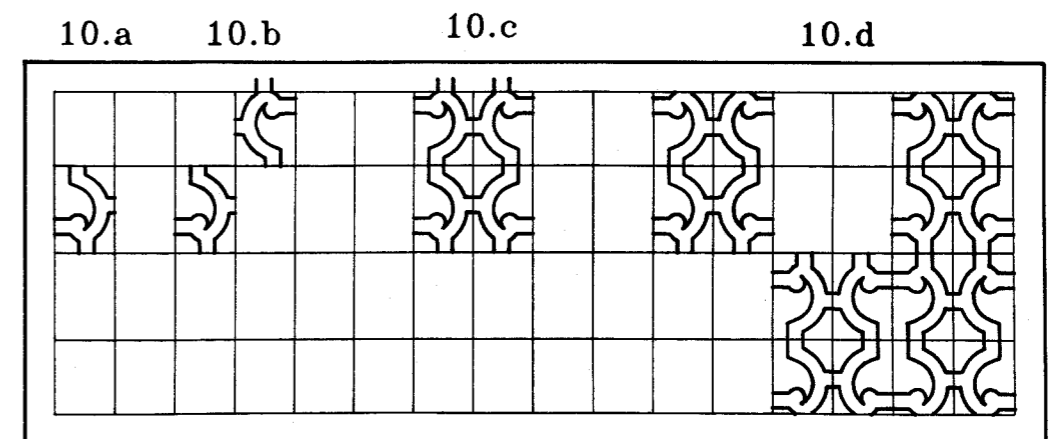

Fig. 10

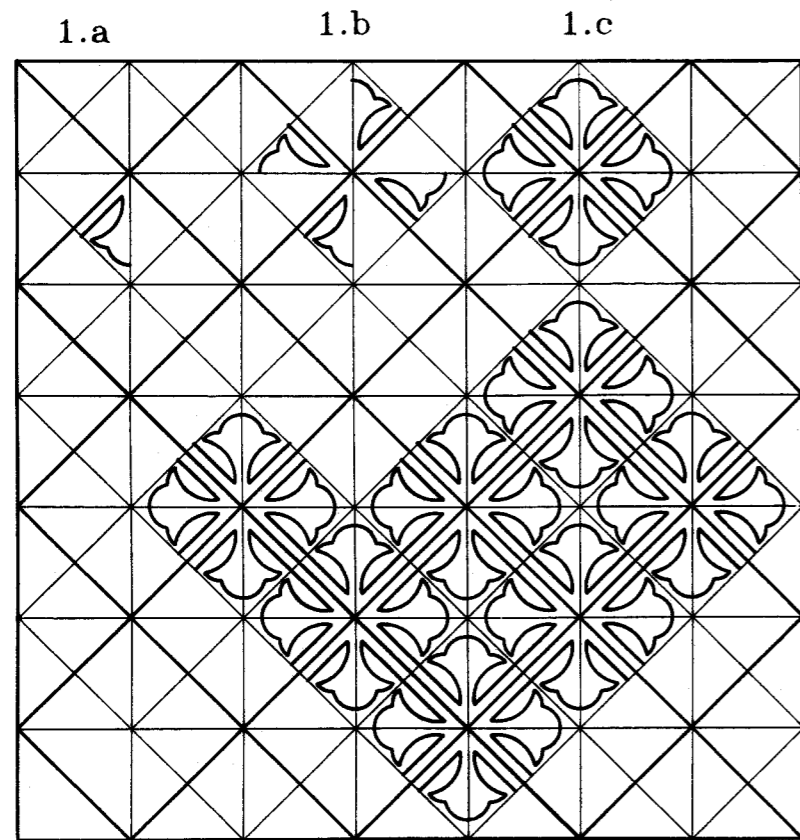
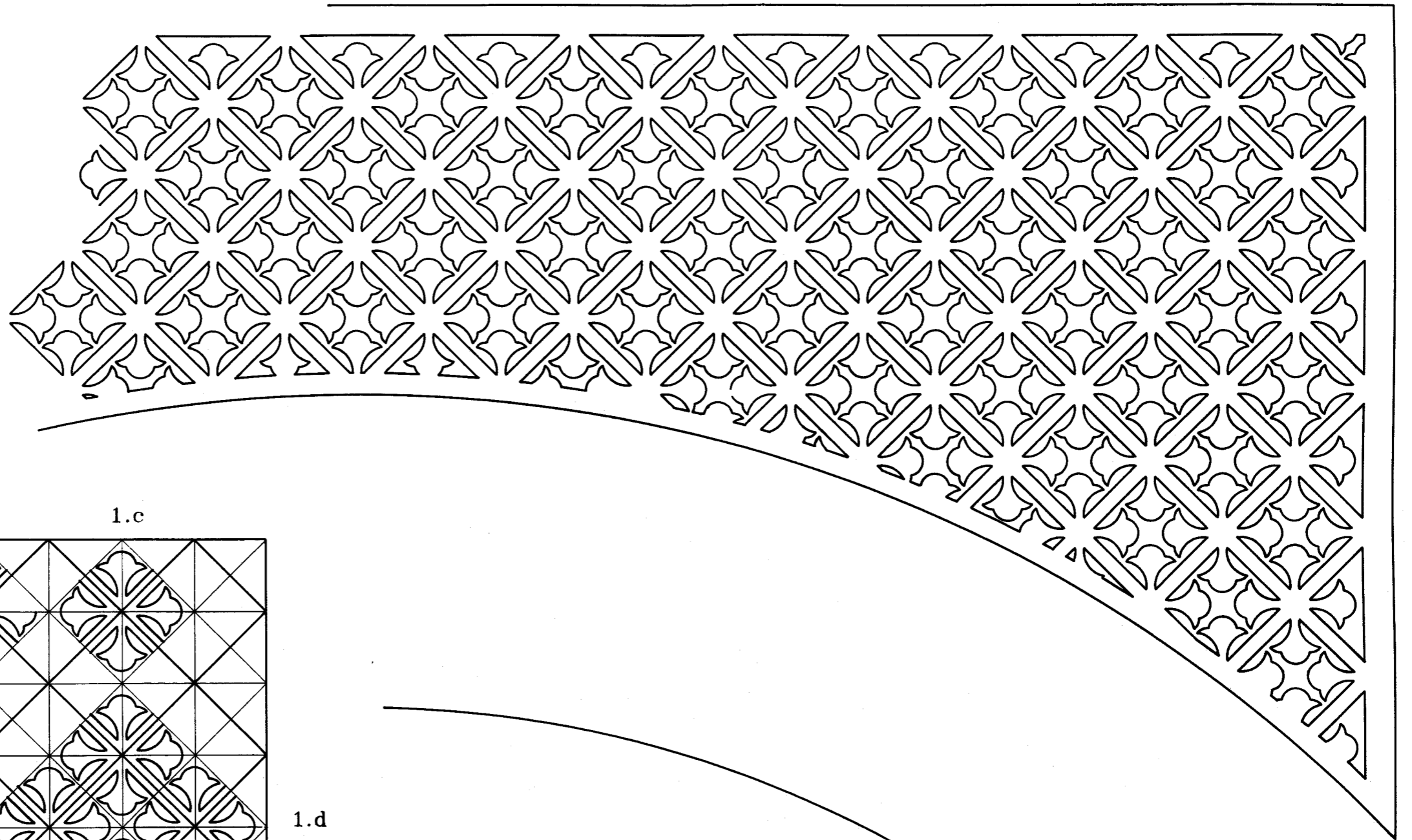

Fig. 1

1.d

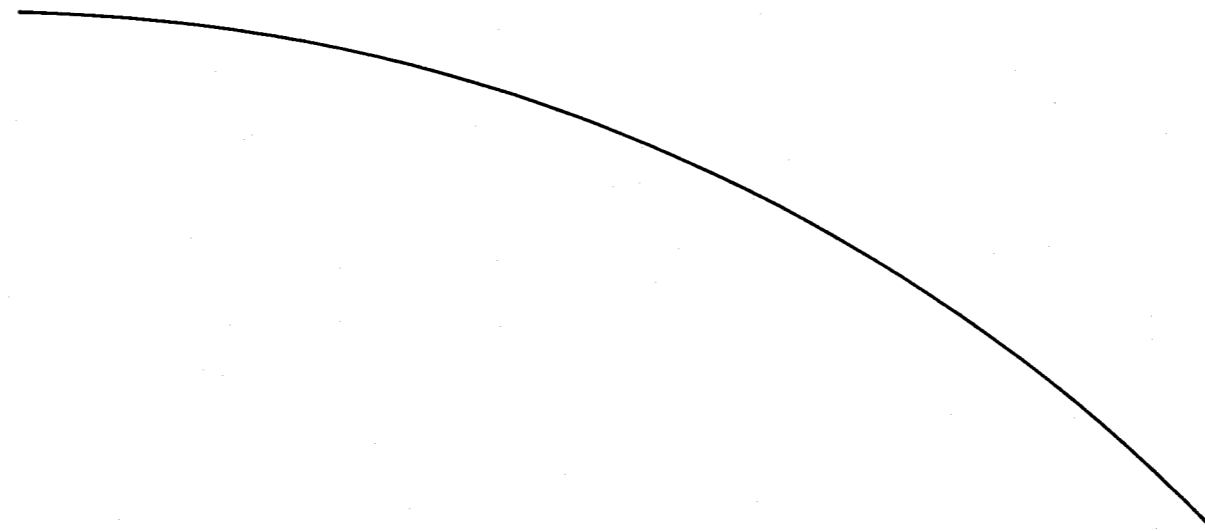

Fig. 2

LAMINA 0301
ARCOS Y DINTELES
TIPOS DE ARRANQUES

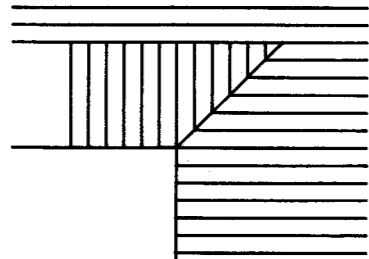

Fig. 1

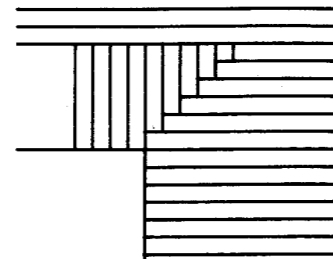

Fig. 2

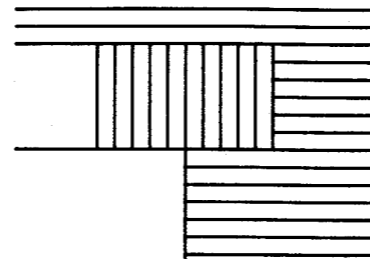

Fig. 3

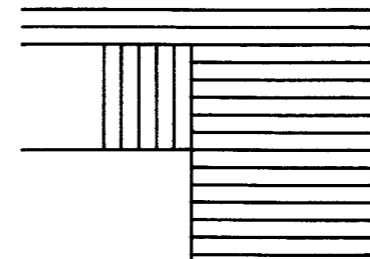

Fig. 4

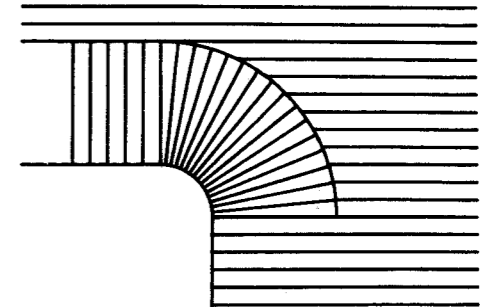

Fig. 5

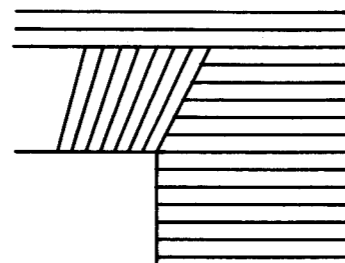

Fig. 6

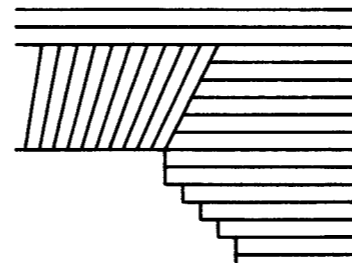

Fig. 7

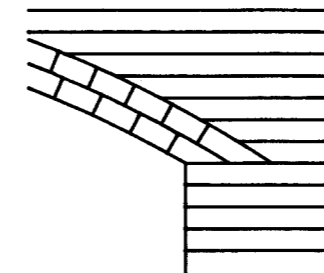

Fig. 8

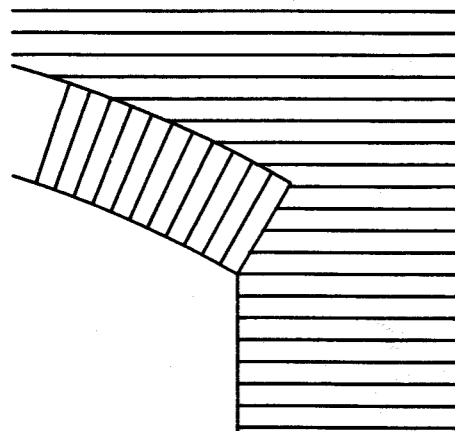

Fig. 9

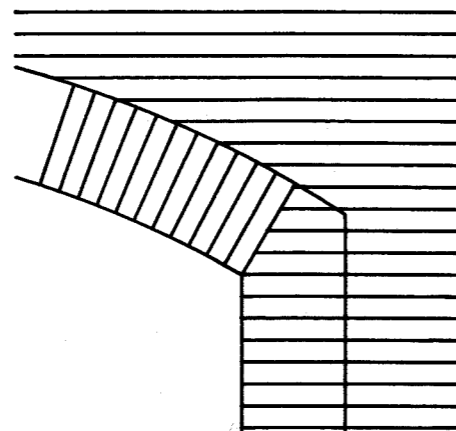

Fig. 10

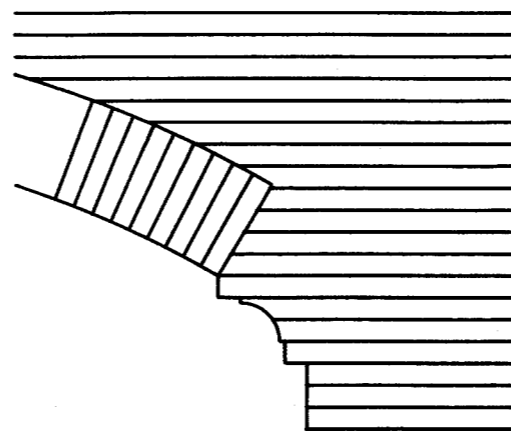

Fig. 11

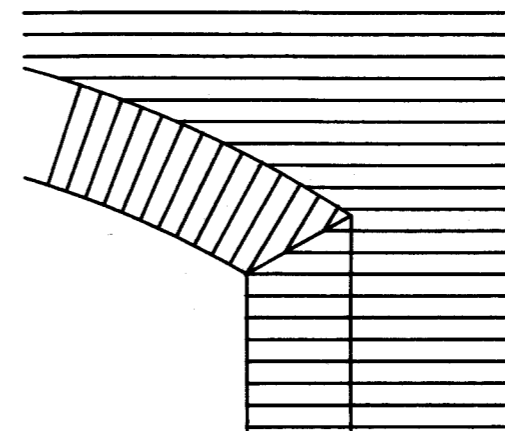

Fig. 12

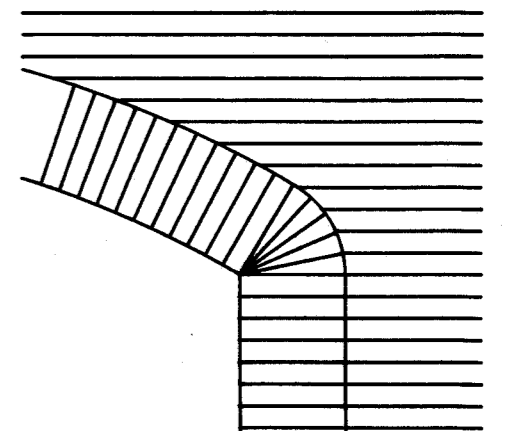

Fig. 13

LAMINA 0302
 ARCOS Y DINTELES
 ESTUDIO DE ARCOS ADINTELADOS

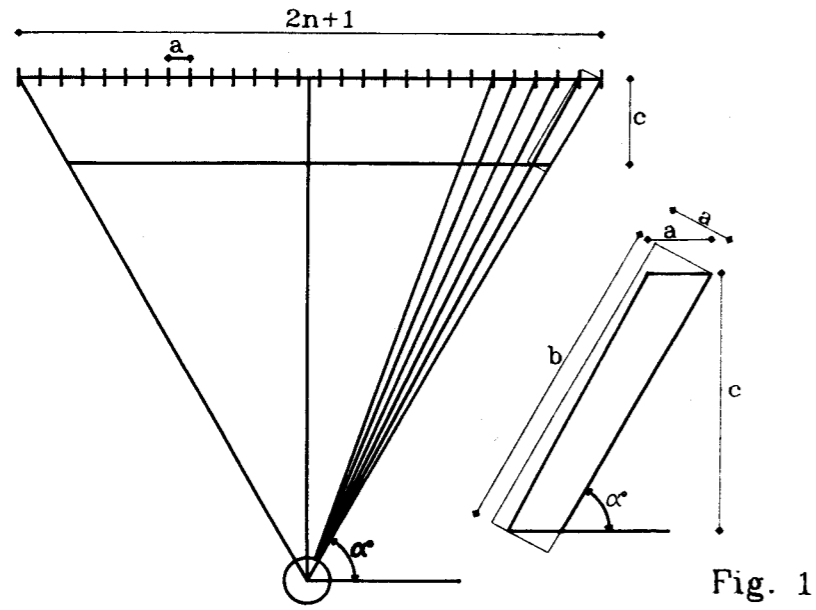

Fig. 1

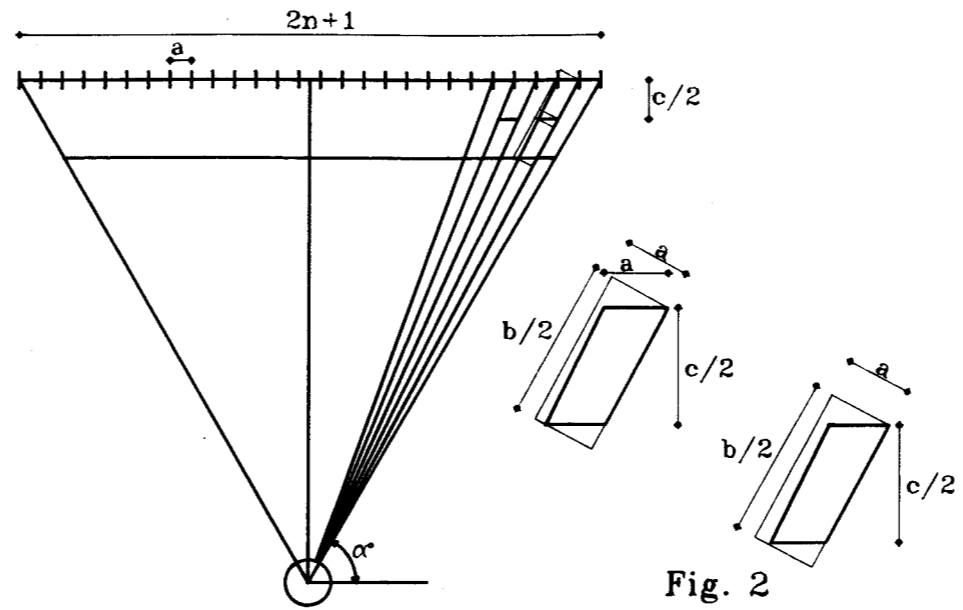

Fig. 2

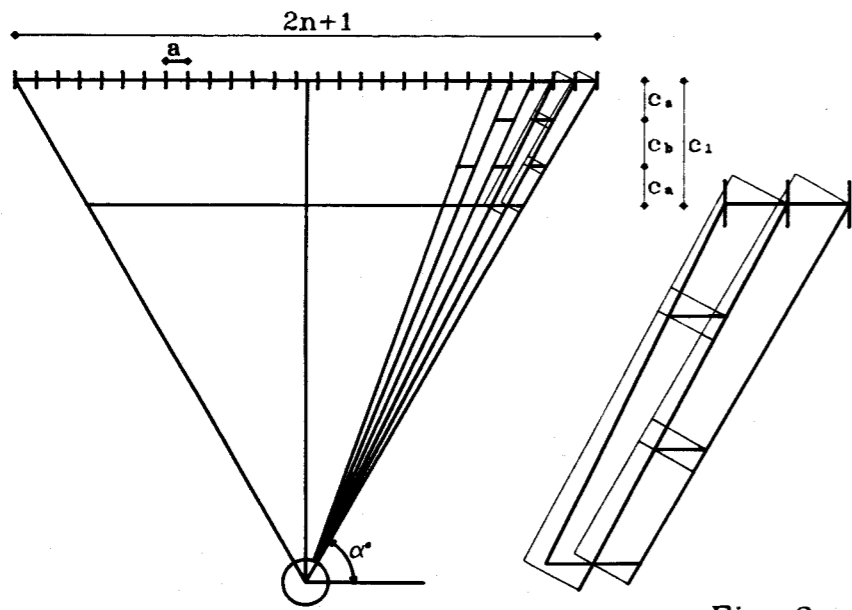

Fig. 3

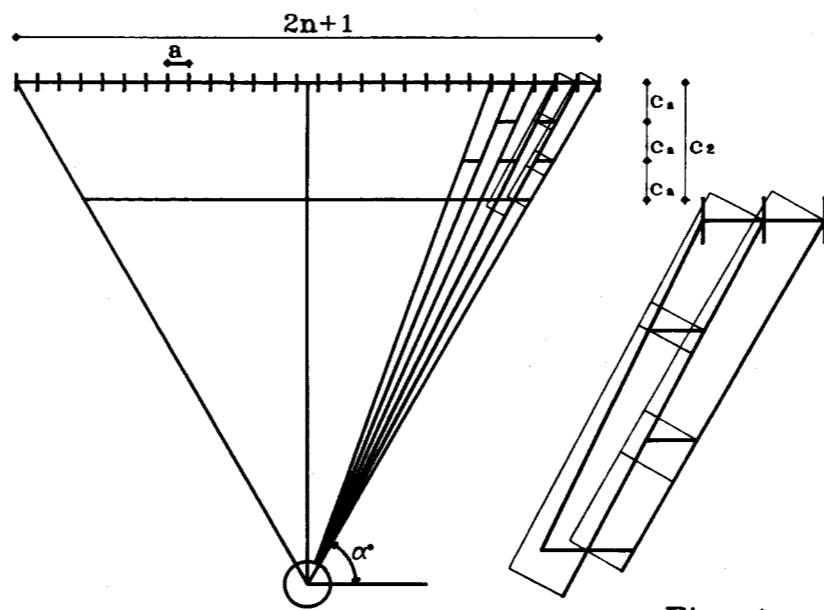

Fig. 4

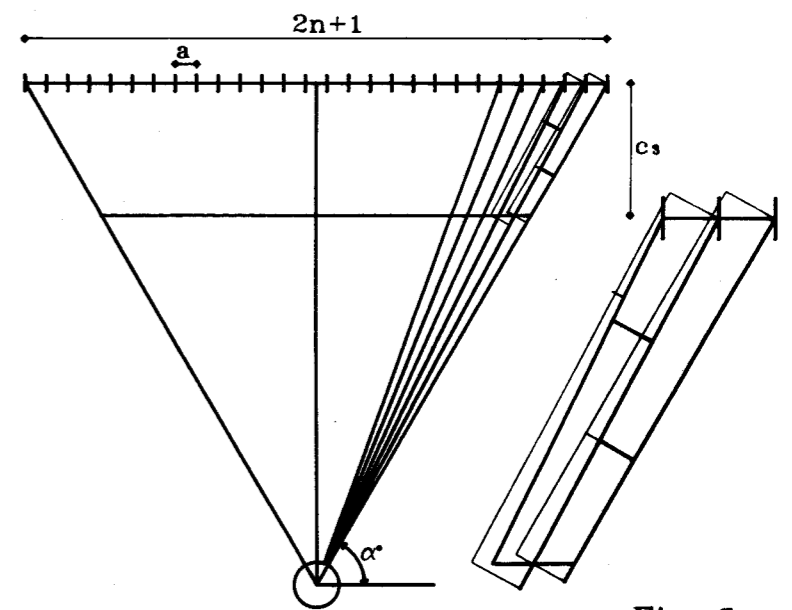

Fig. 5

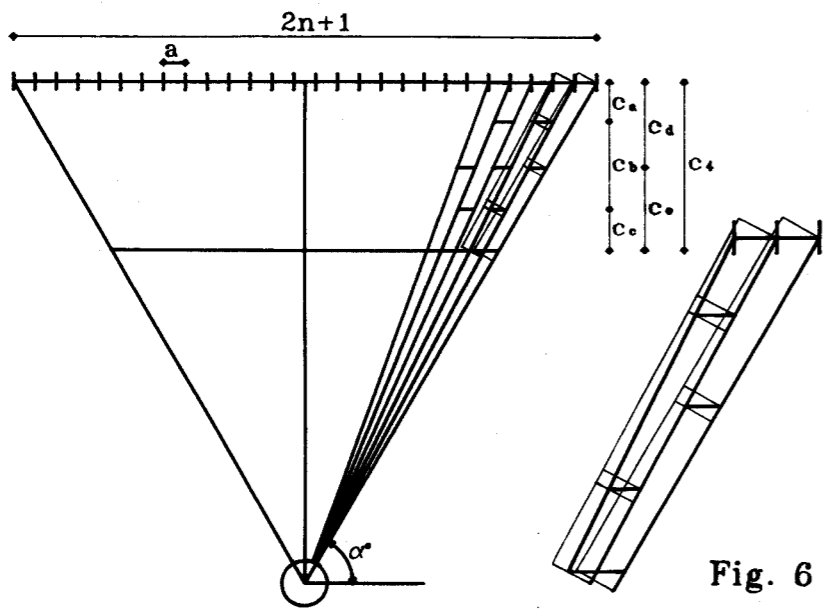

Fig. 6

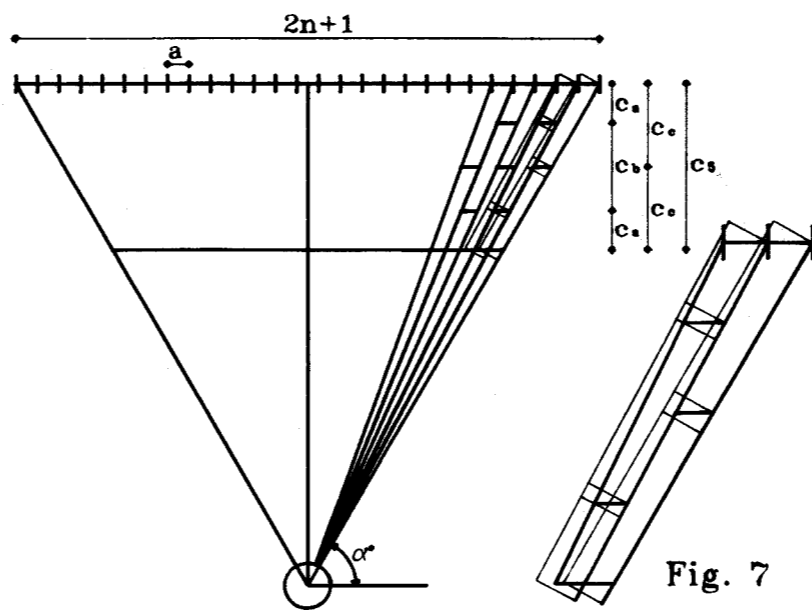

Fig. 7

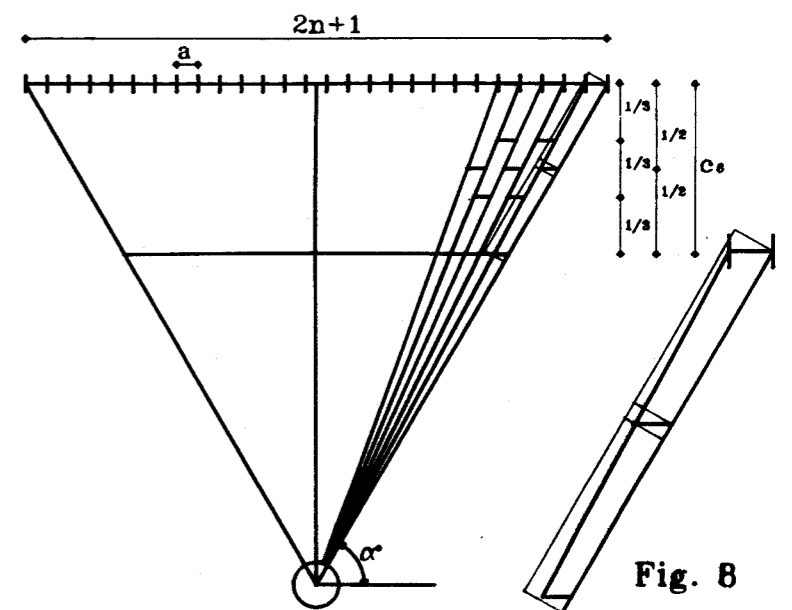

Fig. 8

LAMINA 0303
ARCOS Y DINTELES
ARCOS ADINTELADOS, TIPOS DE APAREJOS

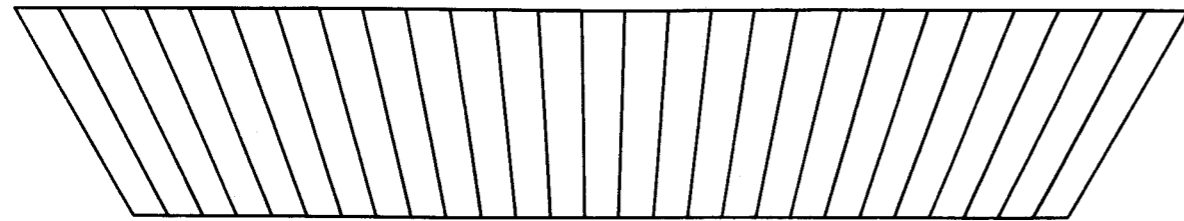

Fig. 1

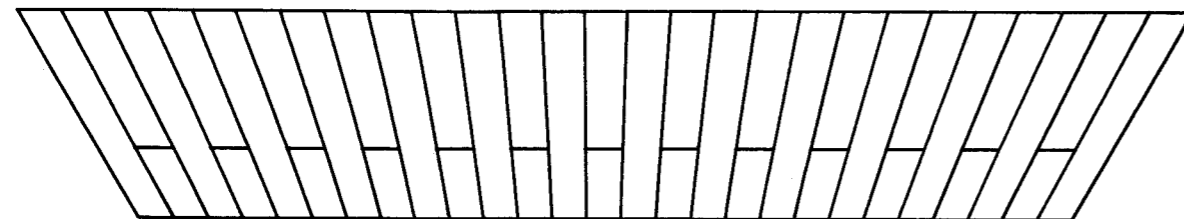
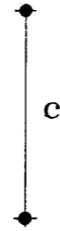

Fig. 2

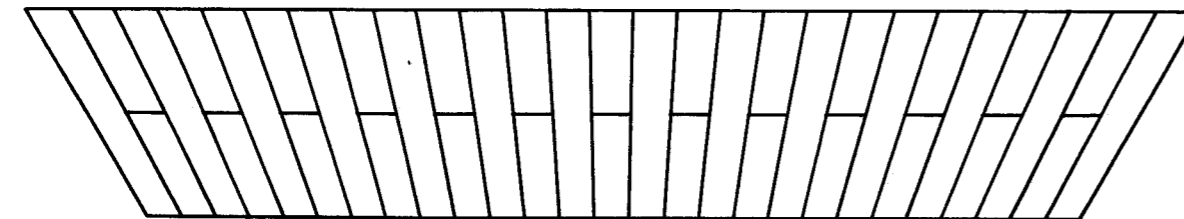
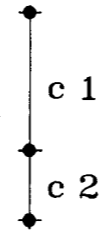

Fig. 3

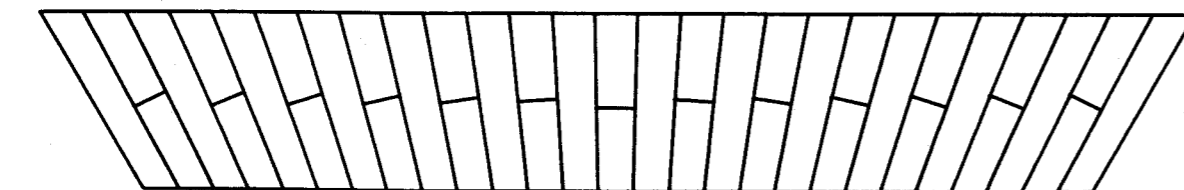
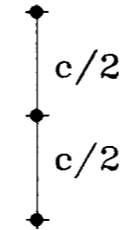

Fig. 4

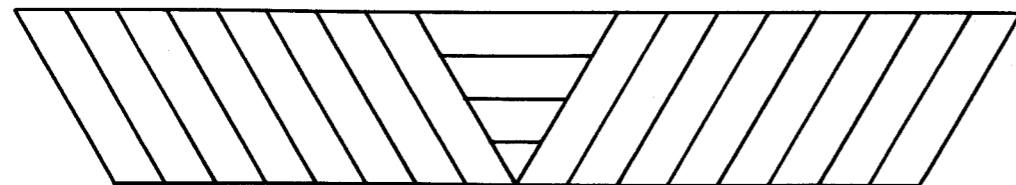

Fig. 5

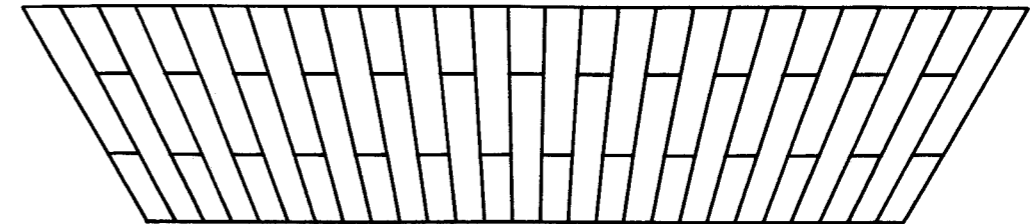

Fig. 6

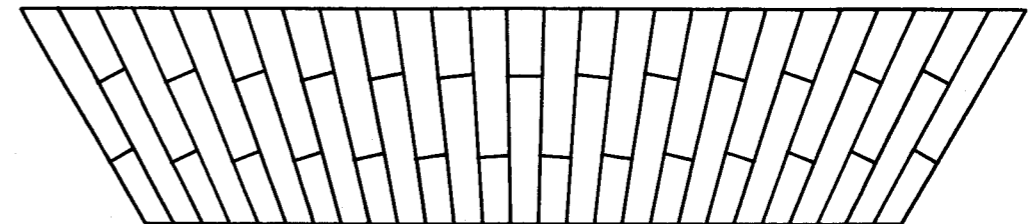

Fig. 7

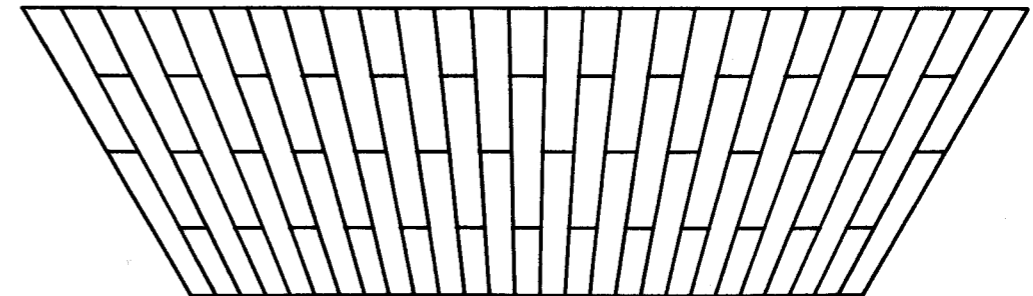

Fig. 8

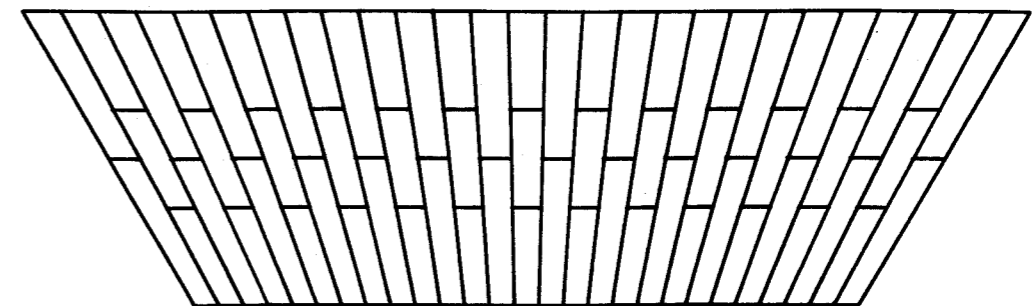

Fig. 9

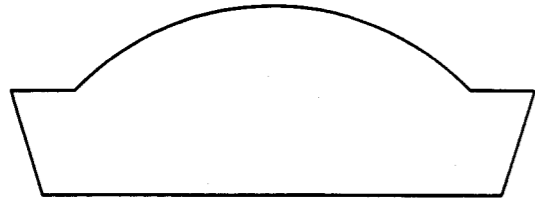

Fig. 1

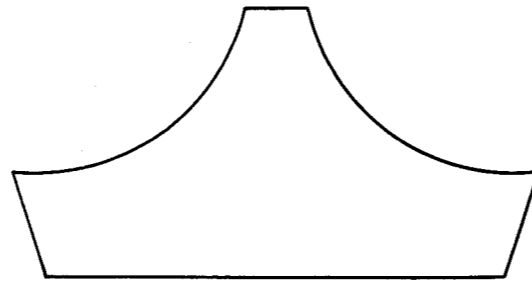

Fig. 2

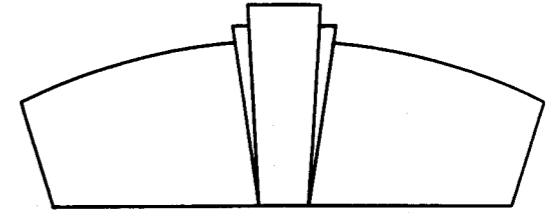

Fig. 3

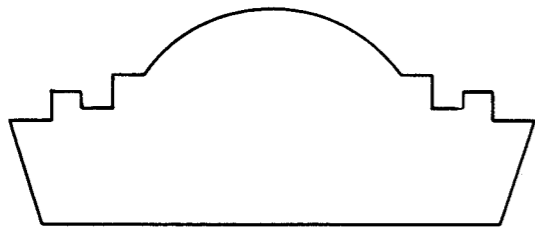

Fig. 4

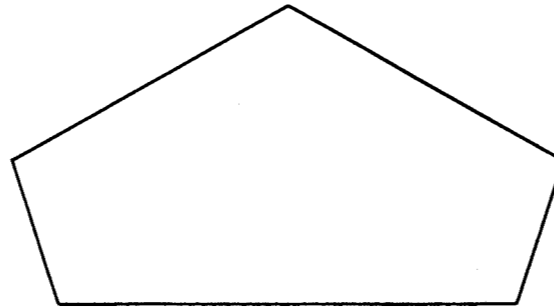

Fig. 5

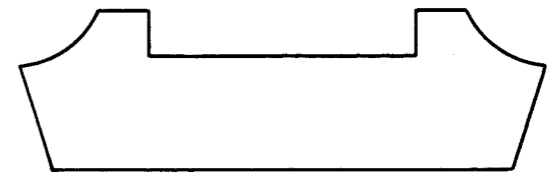

Fig. 6

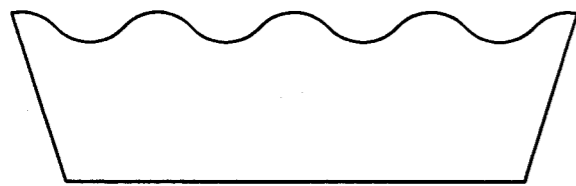

Fig. 7

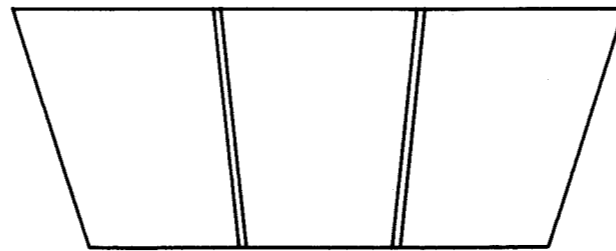

Fig. 8

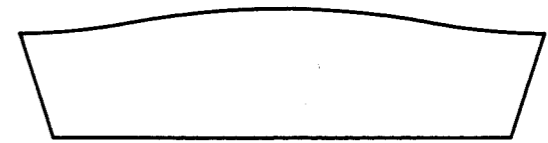

Fig. 9

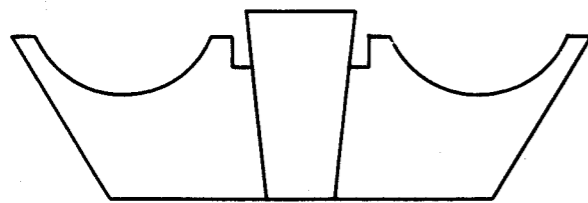

Fig. 10

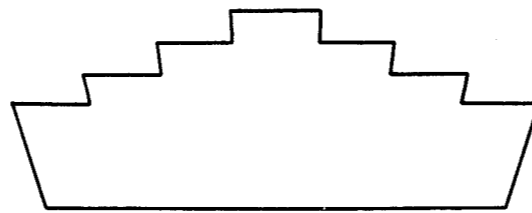

Fig. 11

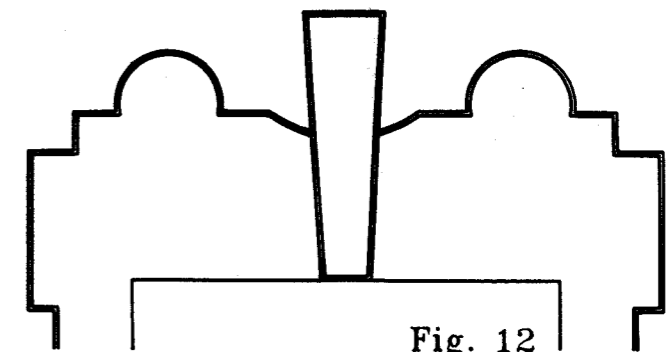

Fig. 12

Fig. 3

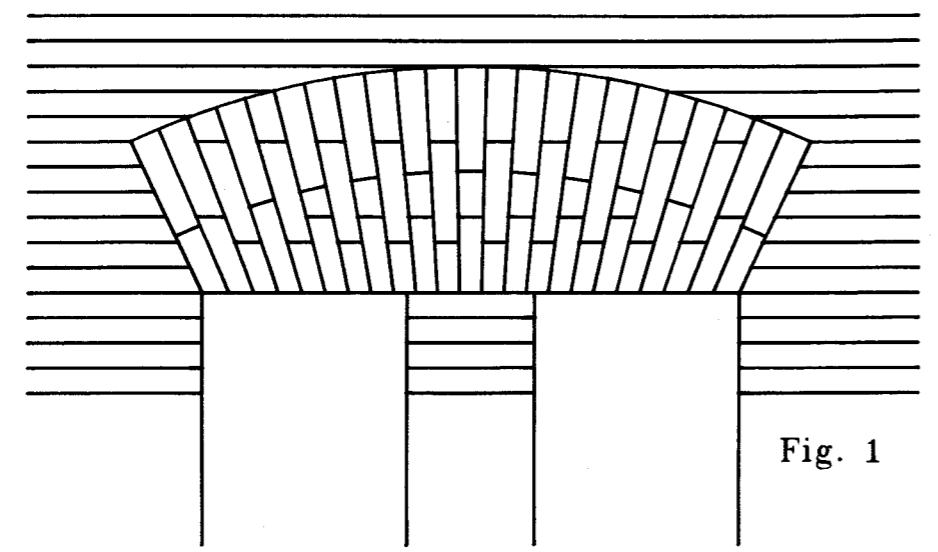

Fig. 1

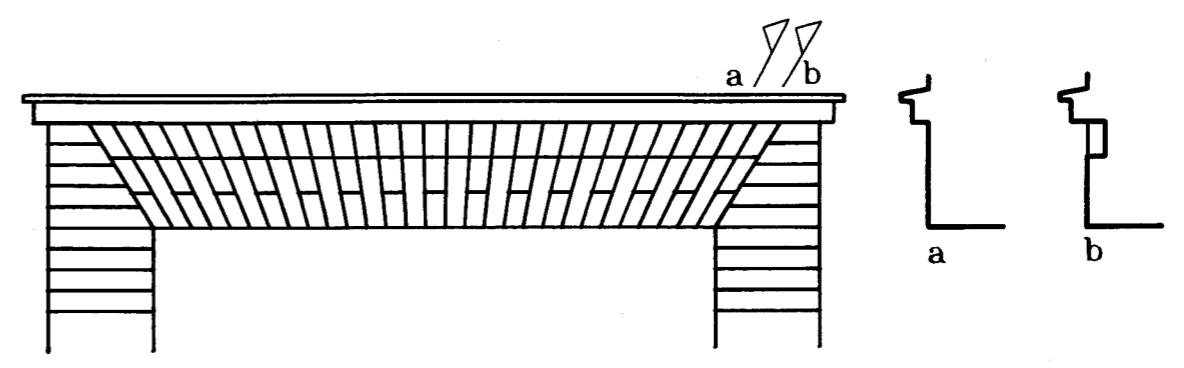

Fig. 3

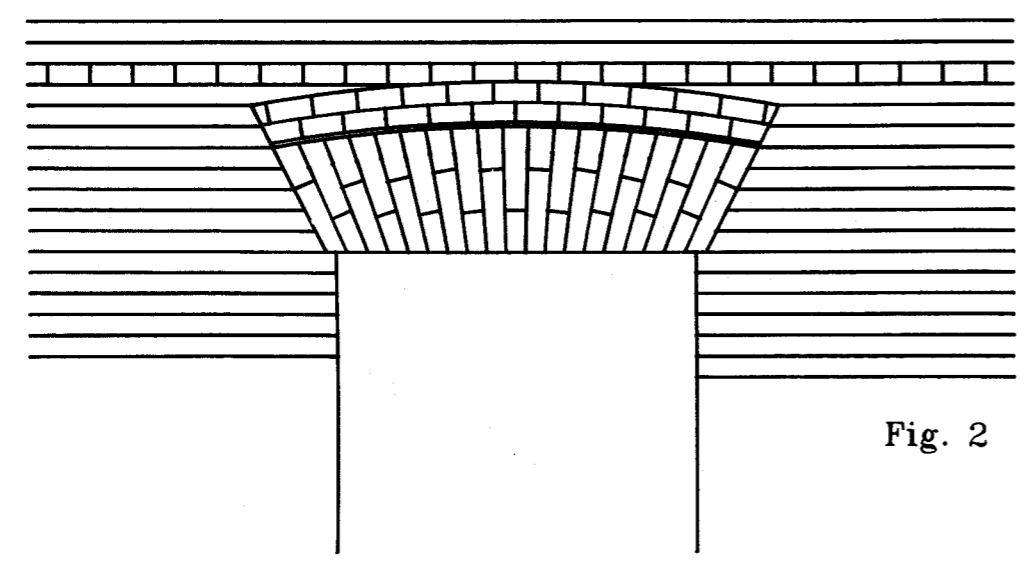

Fig. 2

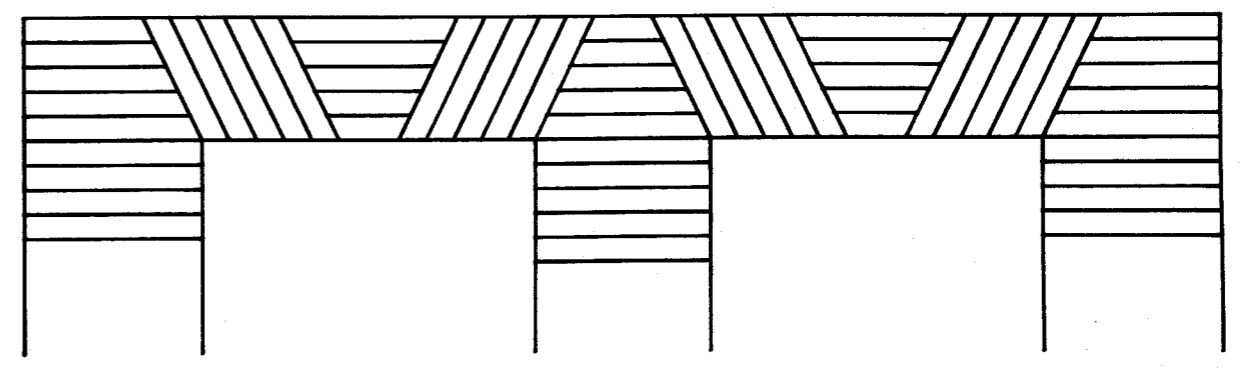

Fig. 4

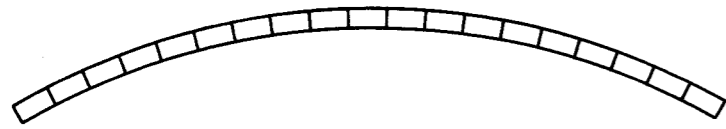

Fig. 1

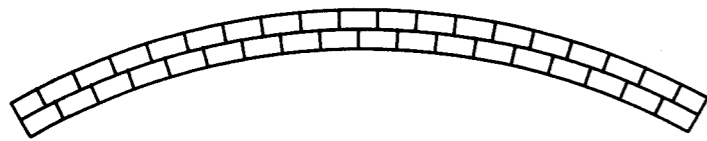

Fig. 2

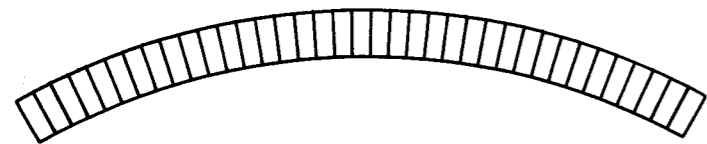

Fig. 3

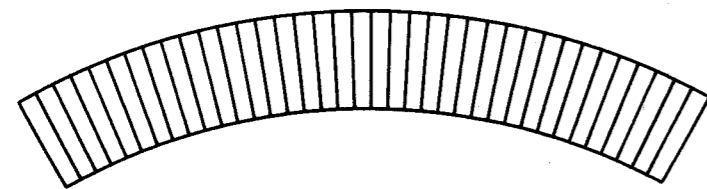

Fig. 4

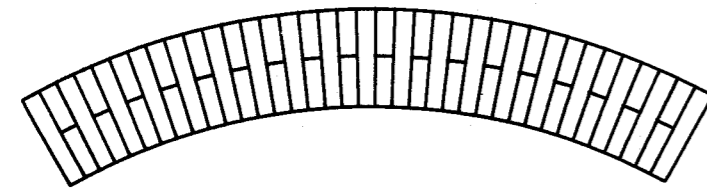

Fig. 5

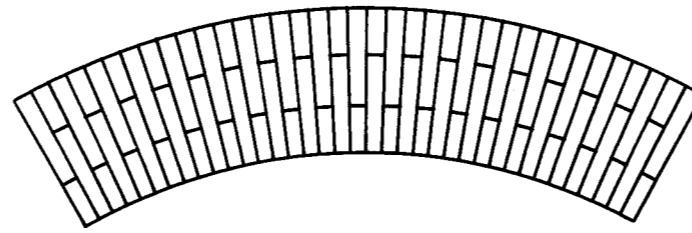

Fig. 6

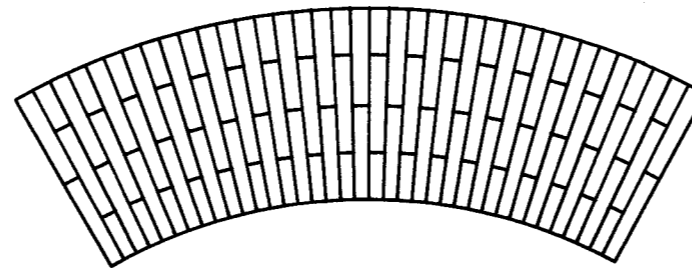

Fig. 7

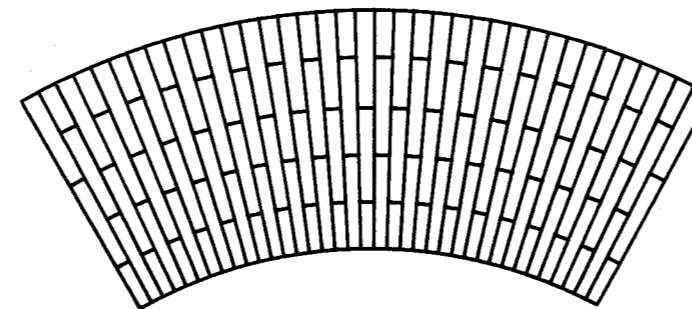

Fig. 8

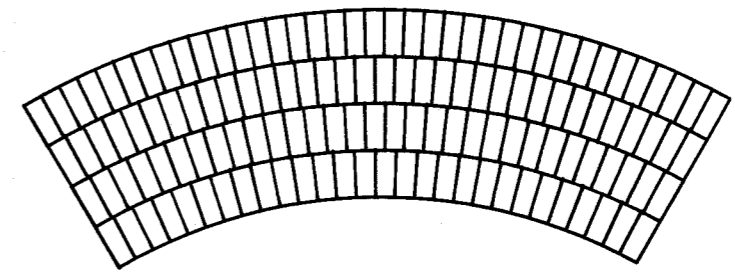

Fig. 9

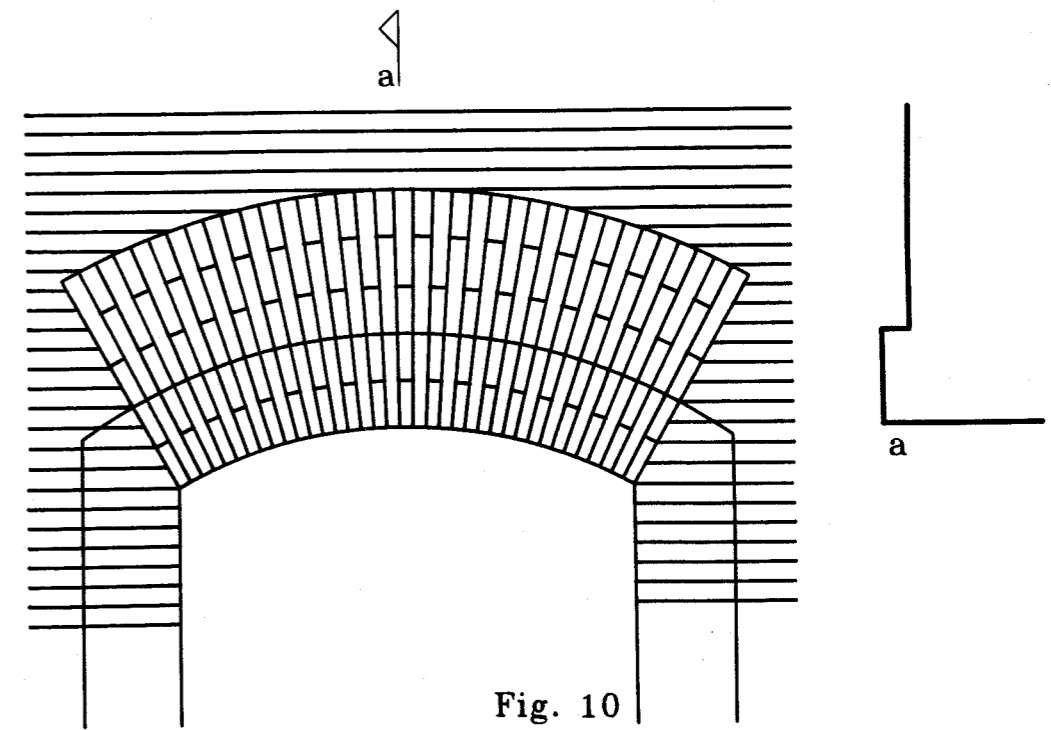

Fig. 10

ARCOS Y DINTELES ARCOS REBAJADOS CON TRASDOS SINGULAR

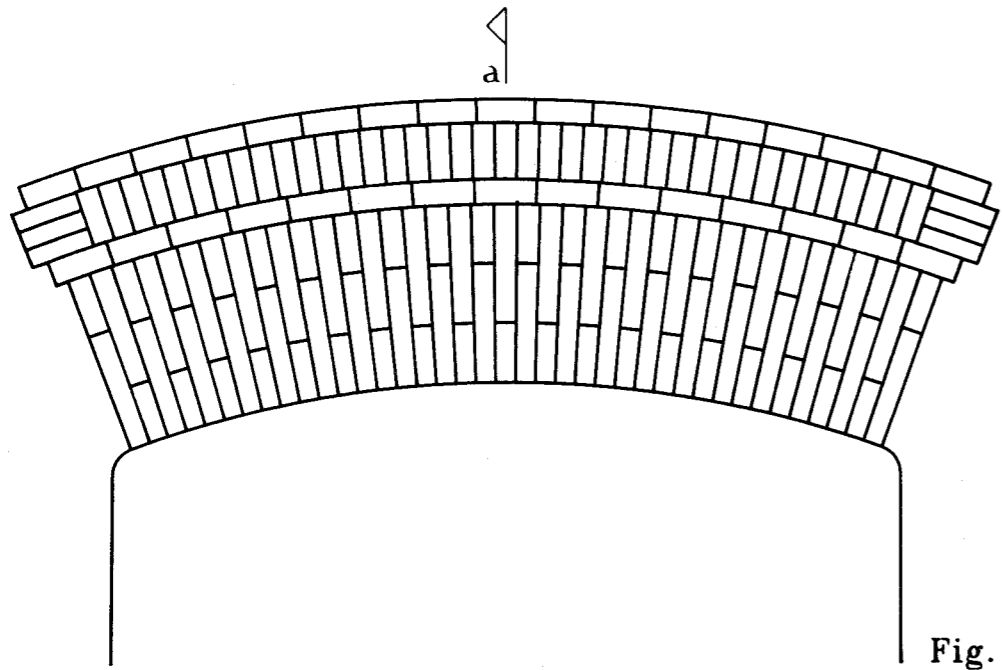

Fig. 1

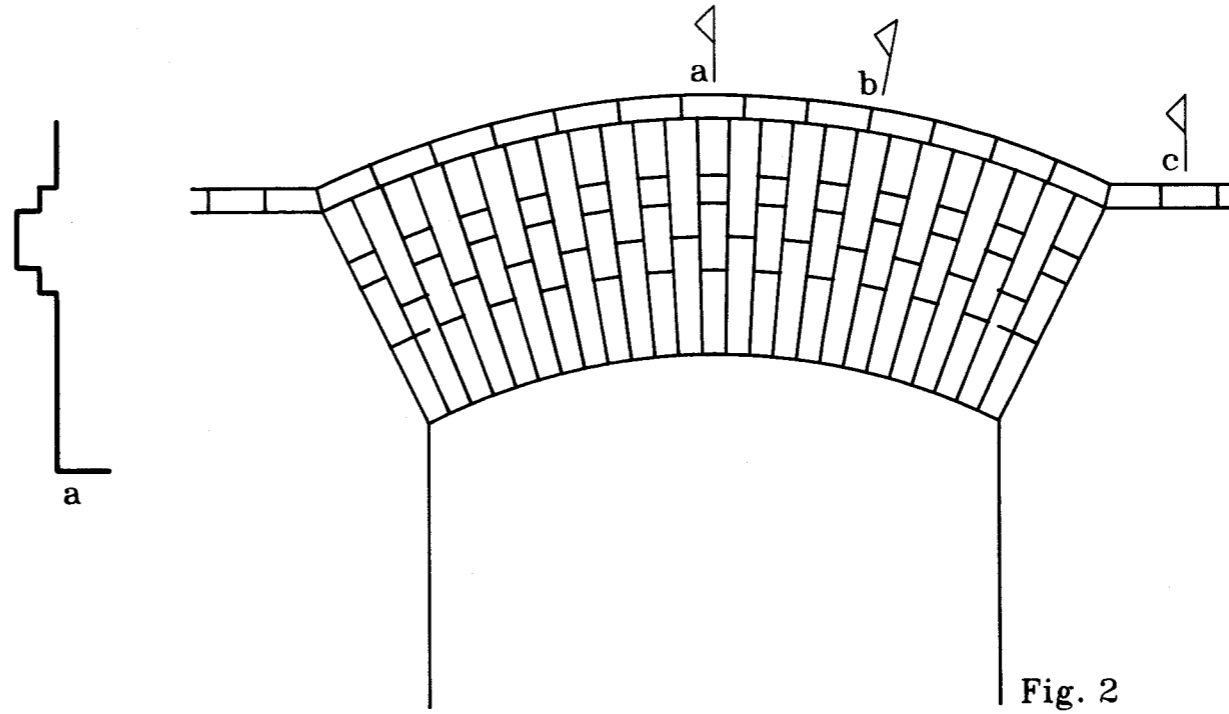

Fig. 2

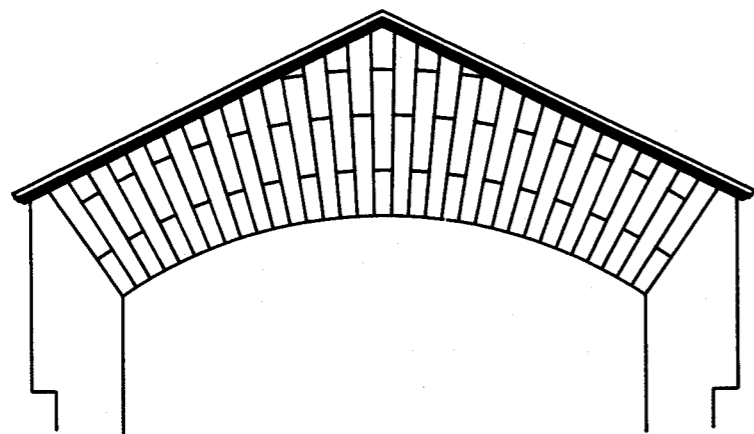
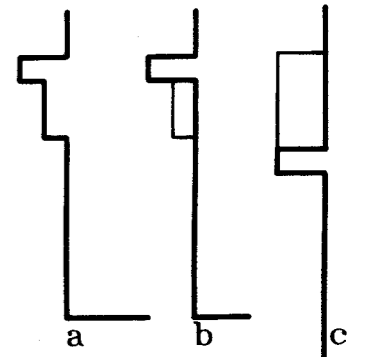

Fig. 3

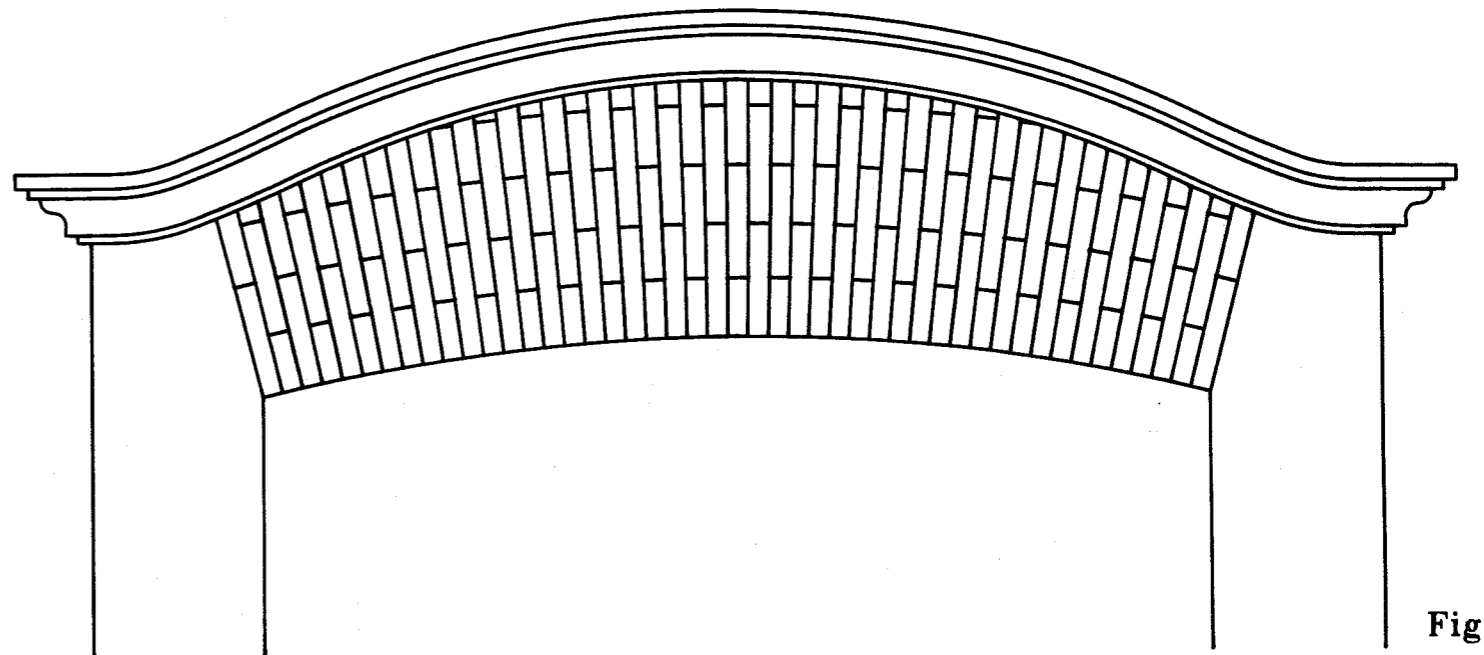

Fig. 4

LAMINA 0308
ARCOS Y DINTELES
ARCOS SINGULARES DE MEDIO PUNTO

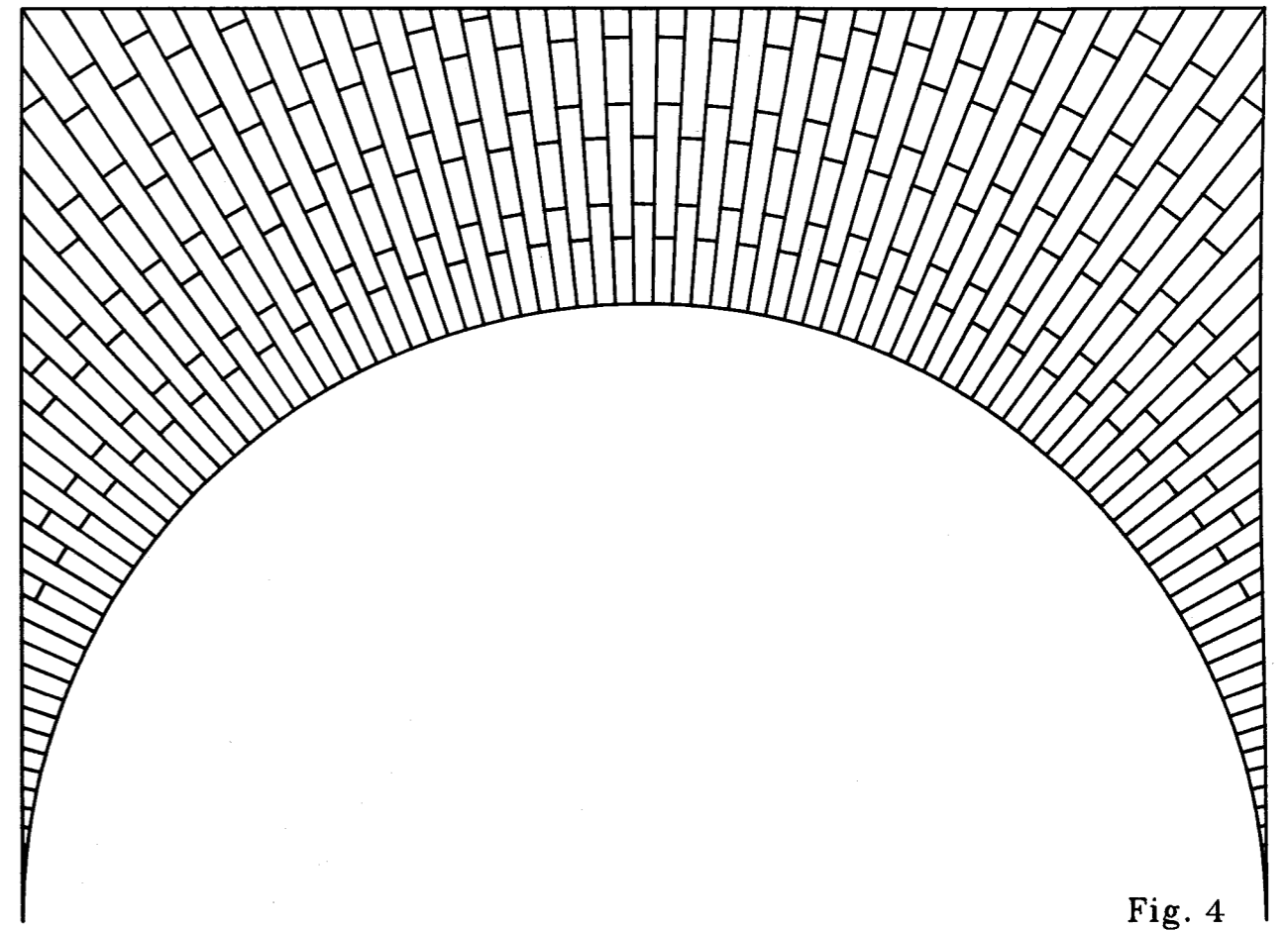
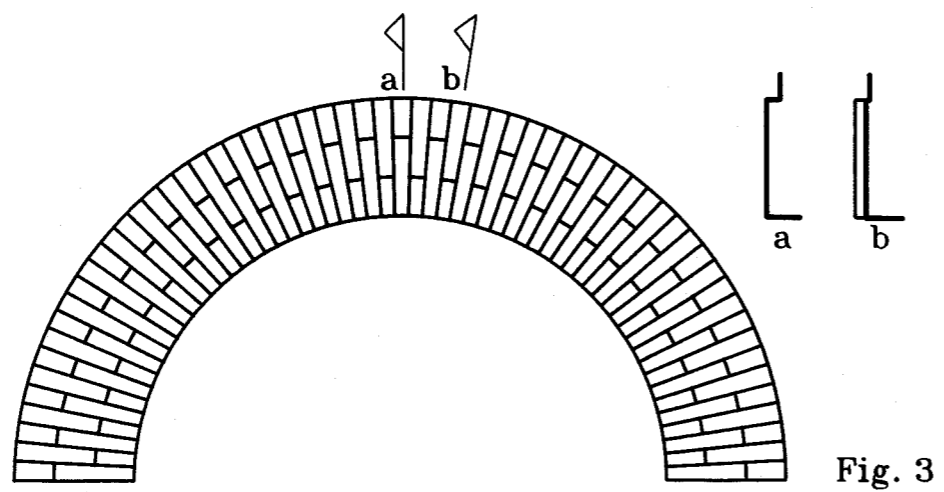
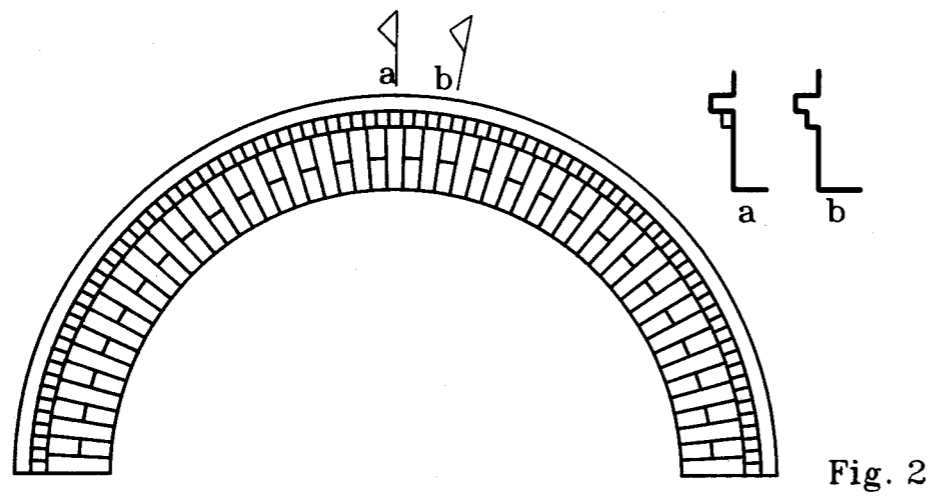
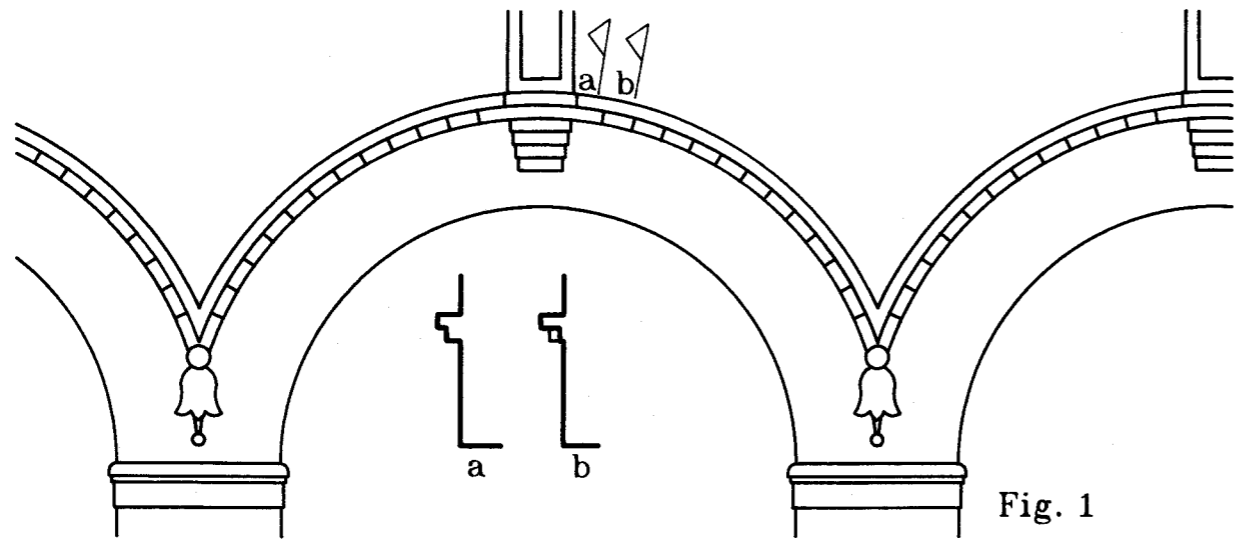

Fig. 4

LAMINA 0309
ARCOS Y DINTELES
ARCOS RECTILINEOS Y MIXTILINEOS

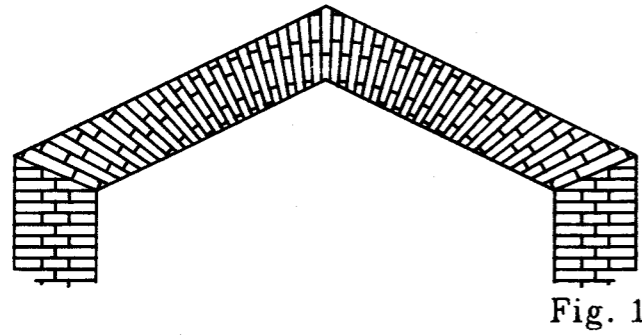

Fig. 1

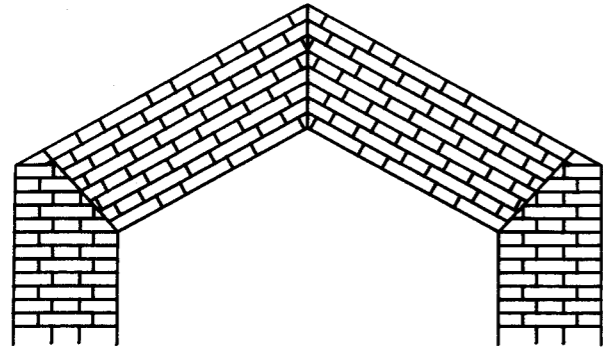
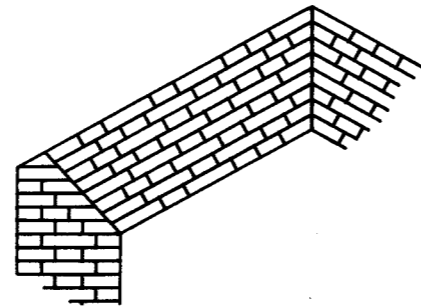

Fig. 2



2.a

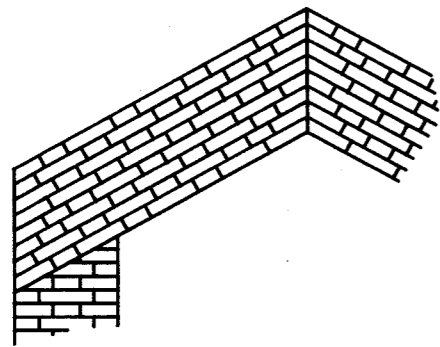

Fig. 3

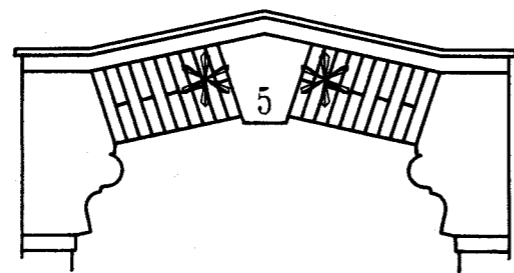
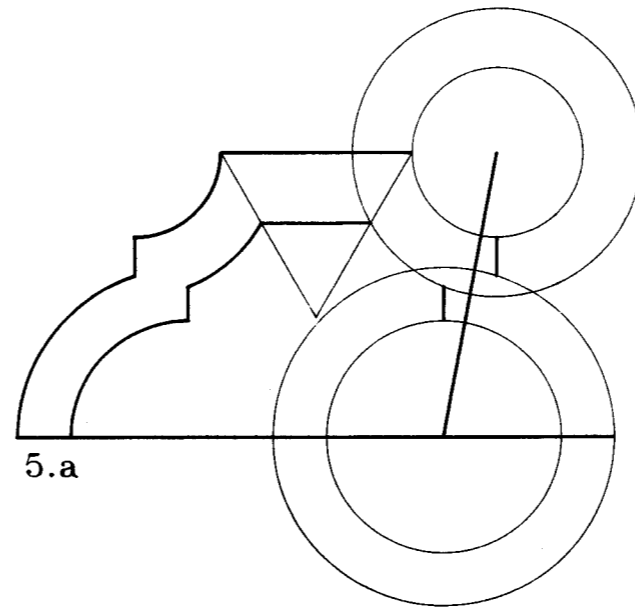
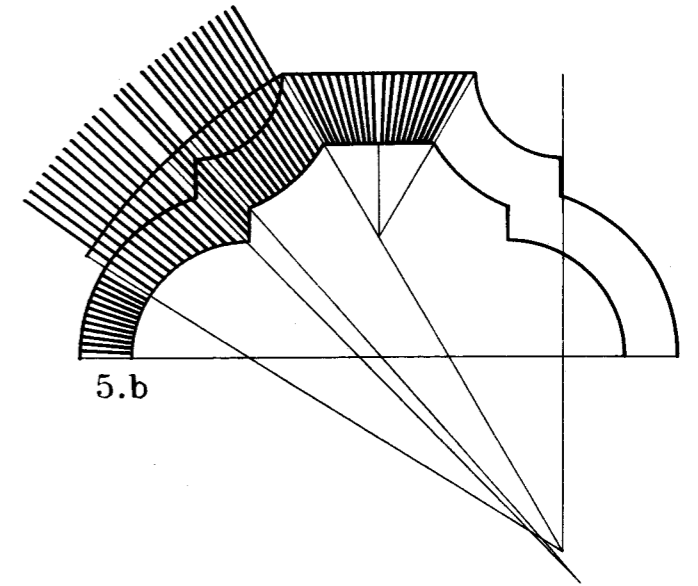

Fig. 4



5.a



5.b

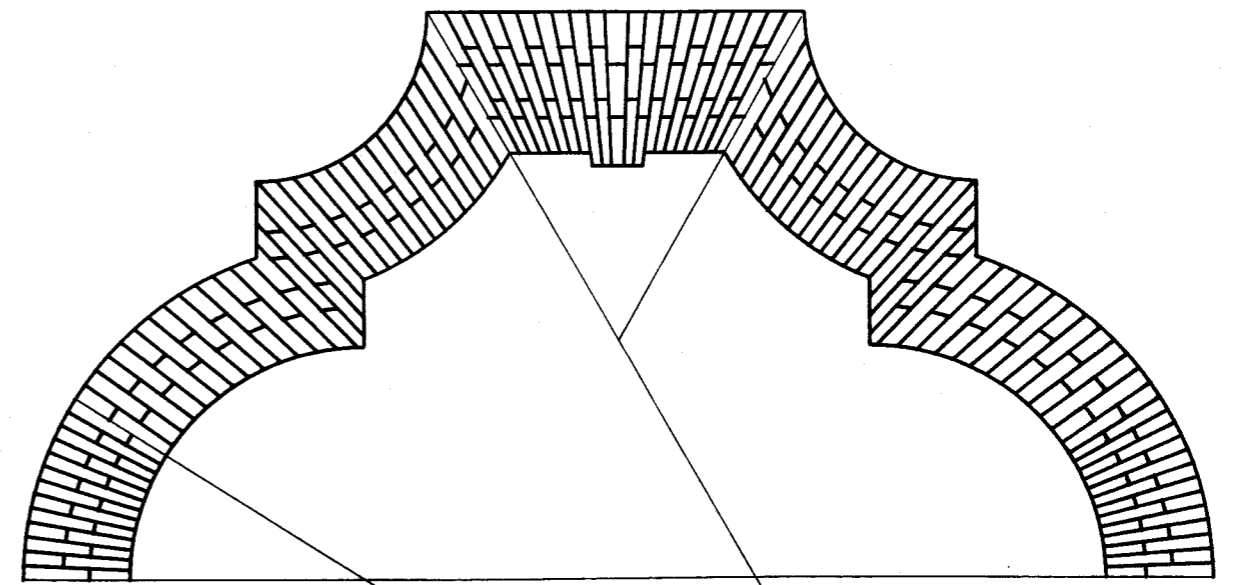
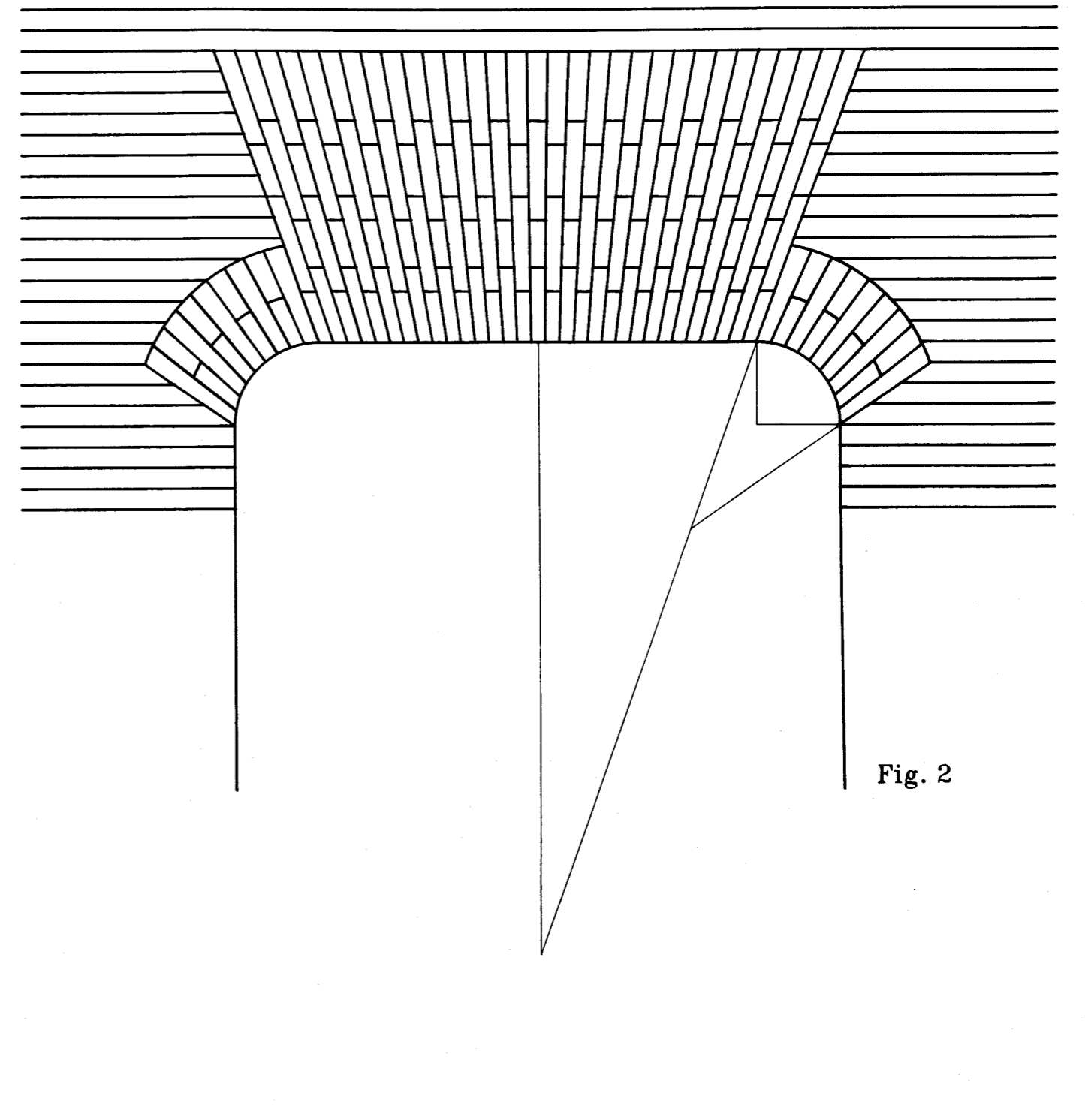
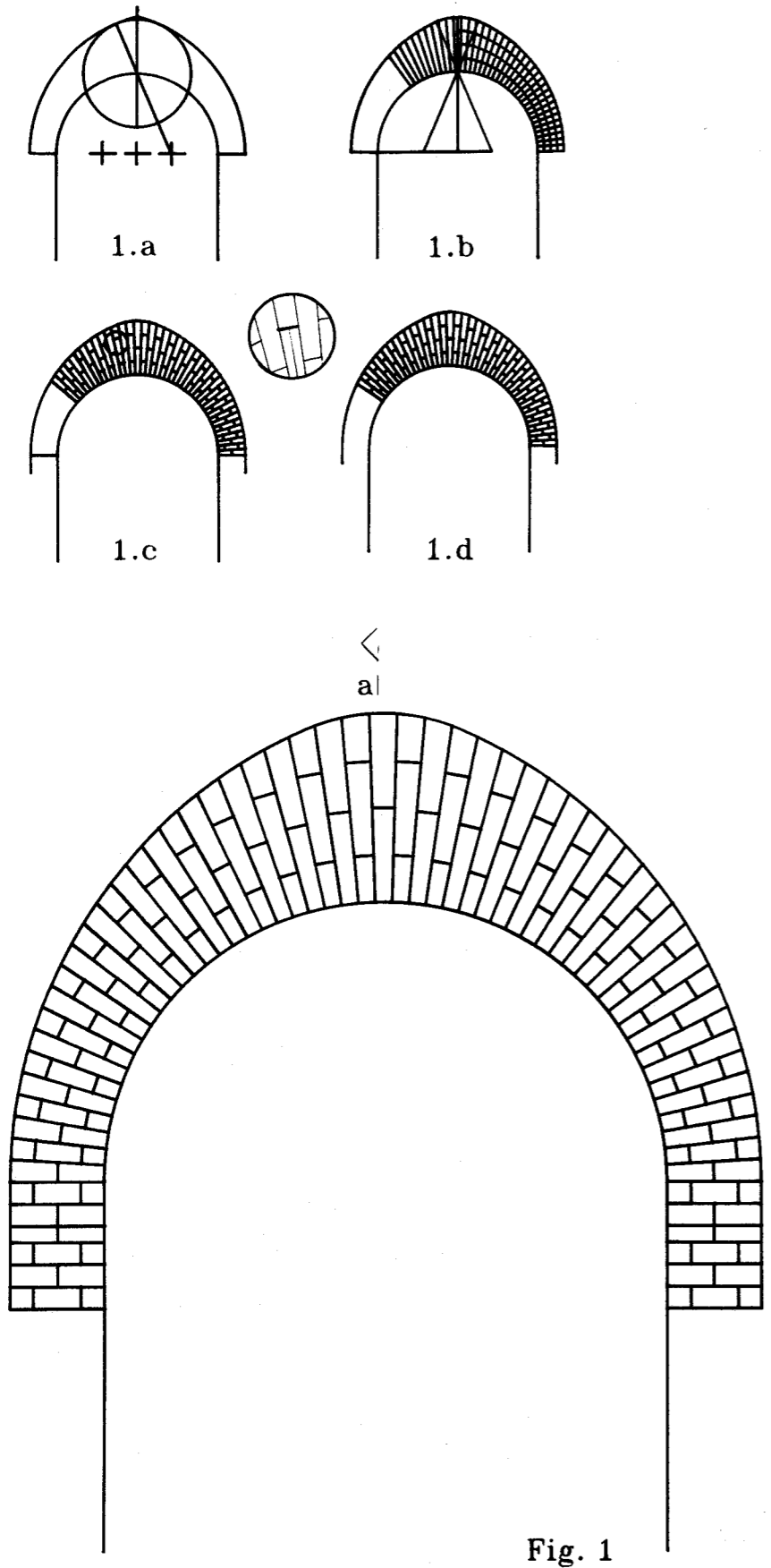

Fig. 5

LAMINA 0310
ARCOS Y DINTELES
ARCOS FLORENTINO Y DEPRIMIDO



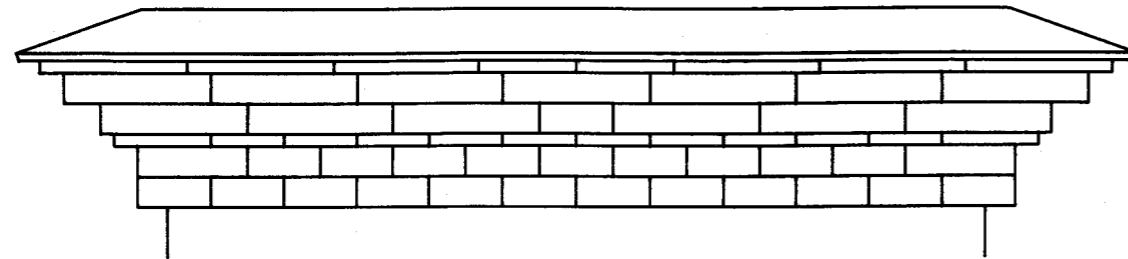

Fig. 1

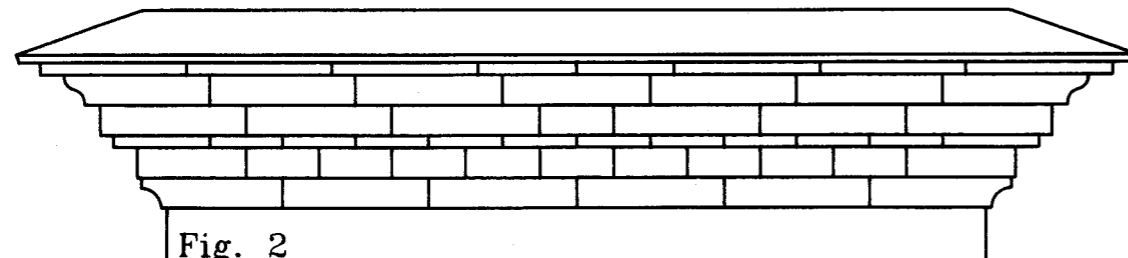

Fig. 2

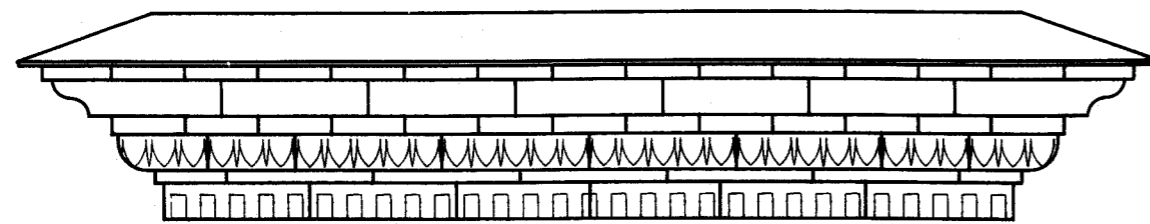

Fig. 3

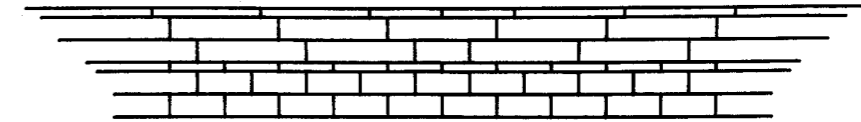
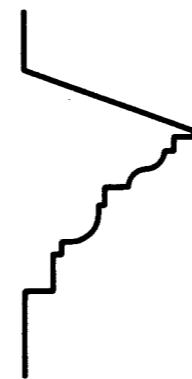
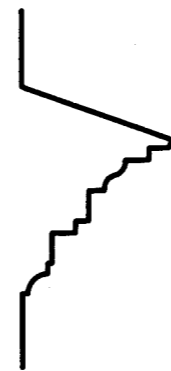
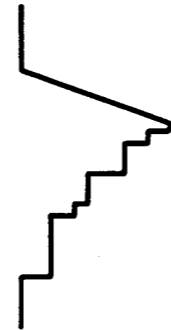

Fig. 4.a

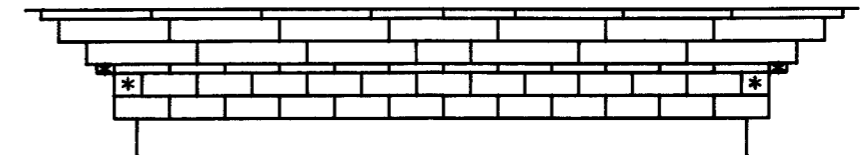

Fig. 4.b

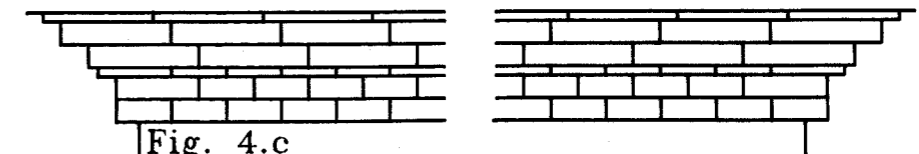

Fig. 4.c

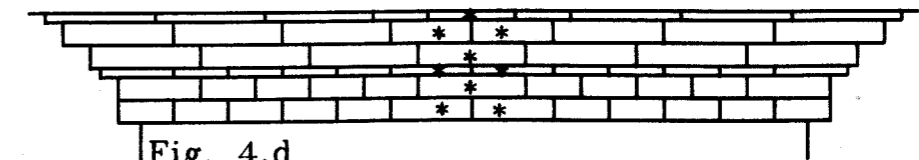
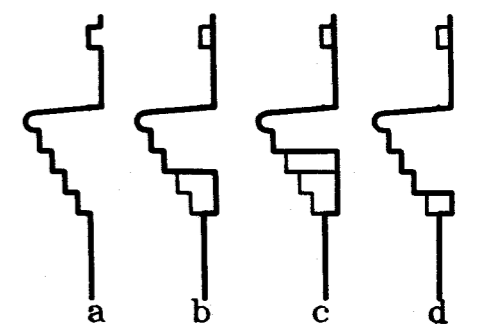
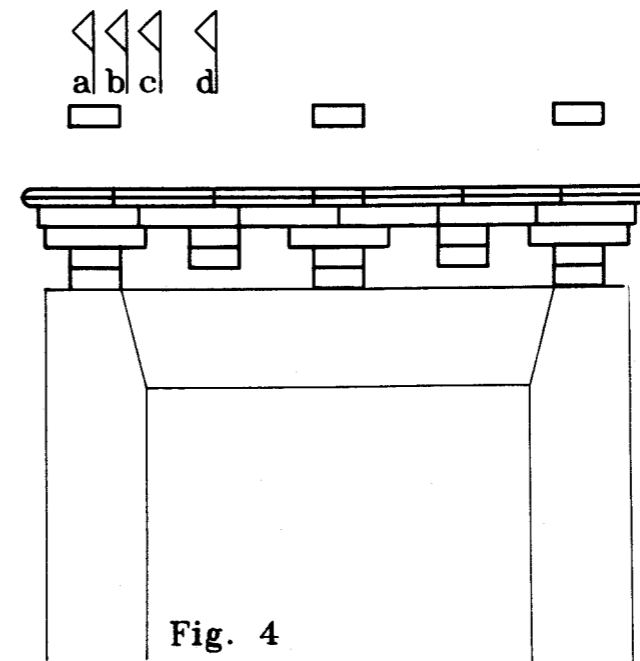
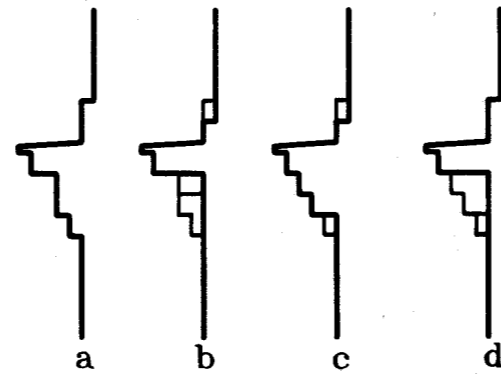
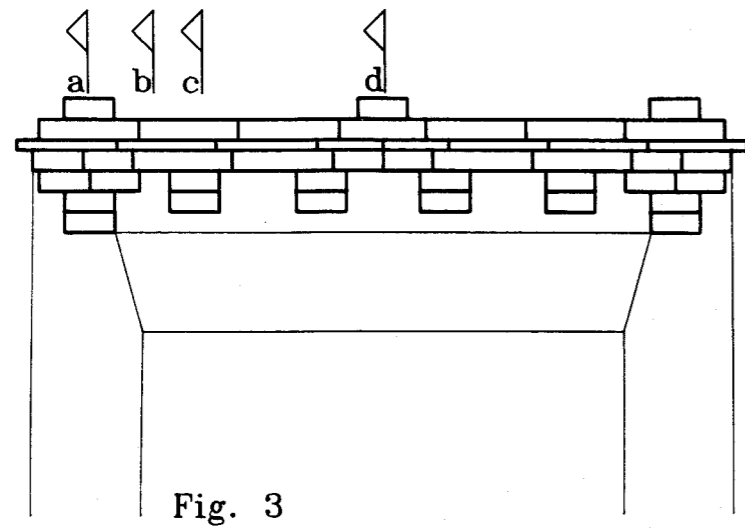
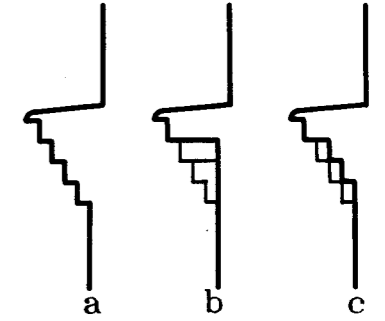
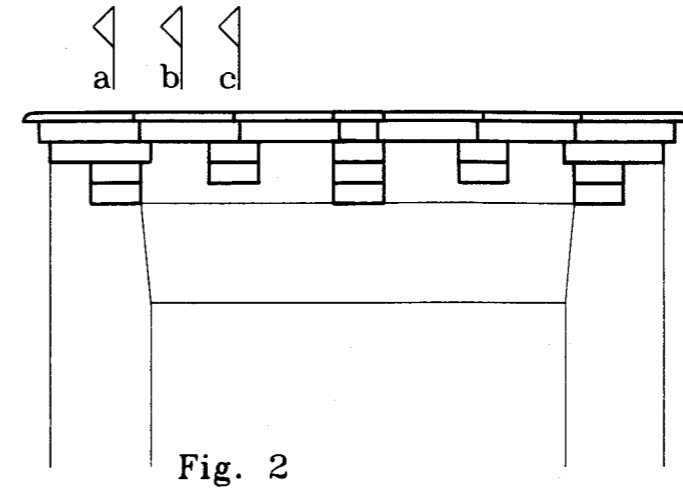
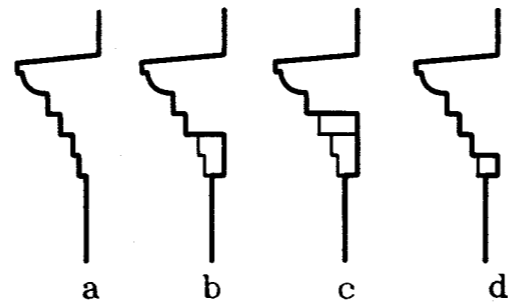
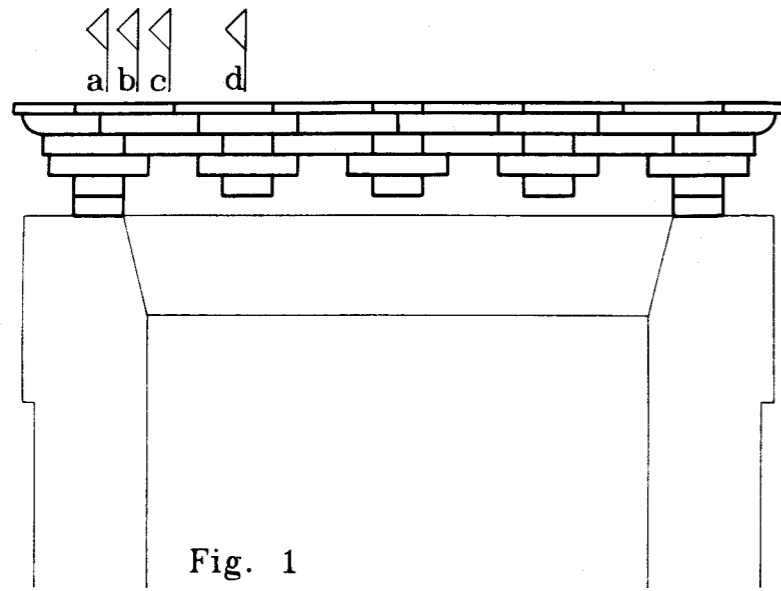

Fig. 4.d



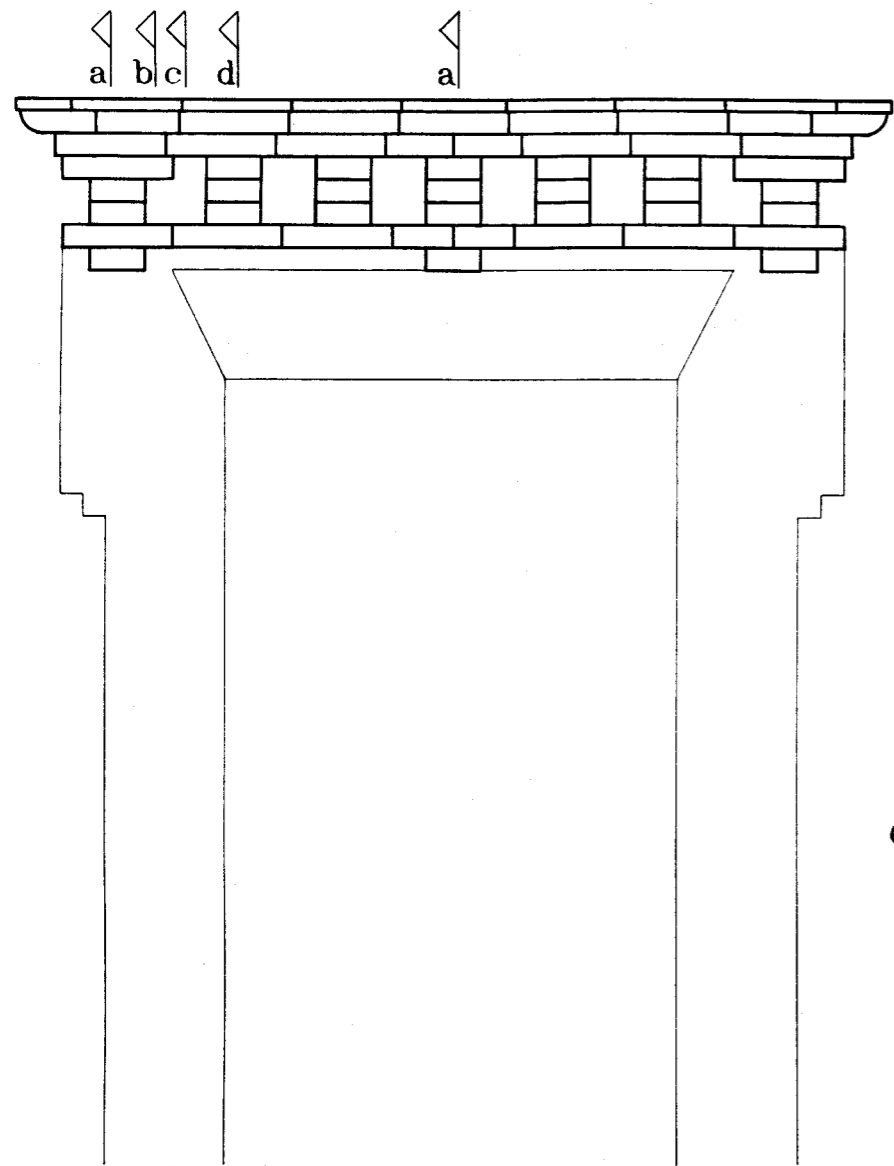

Fig. 5

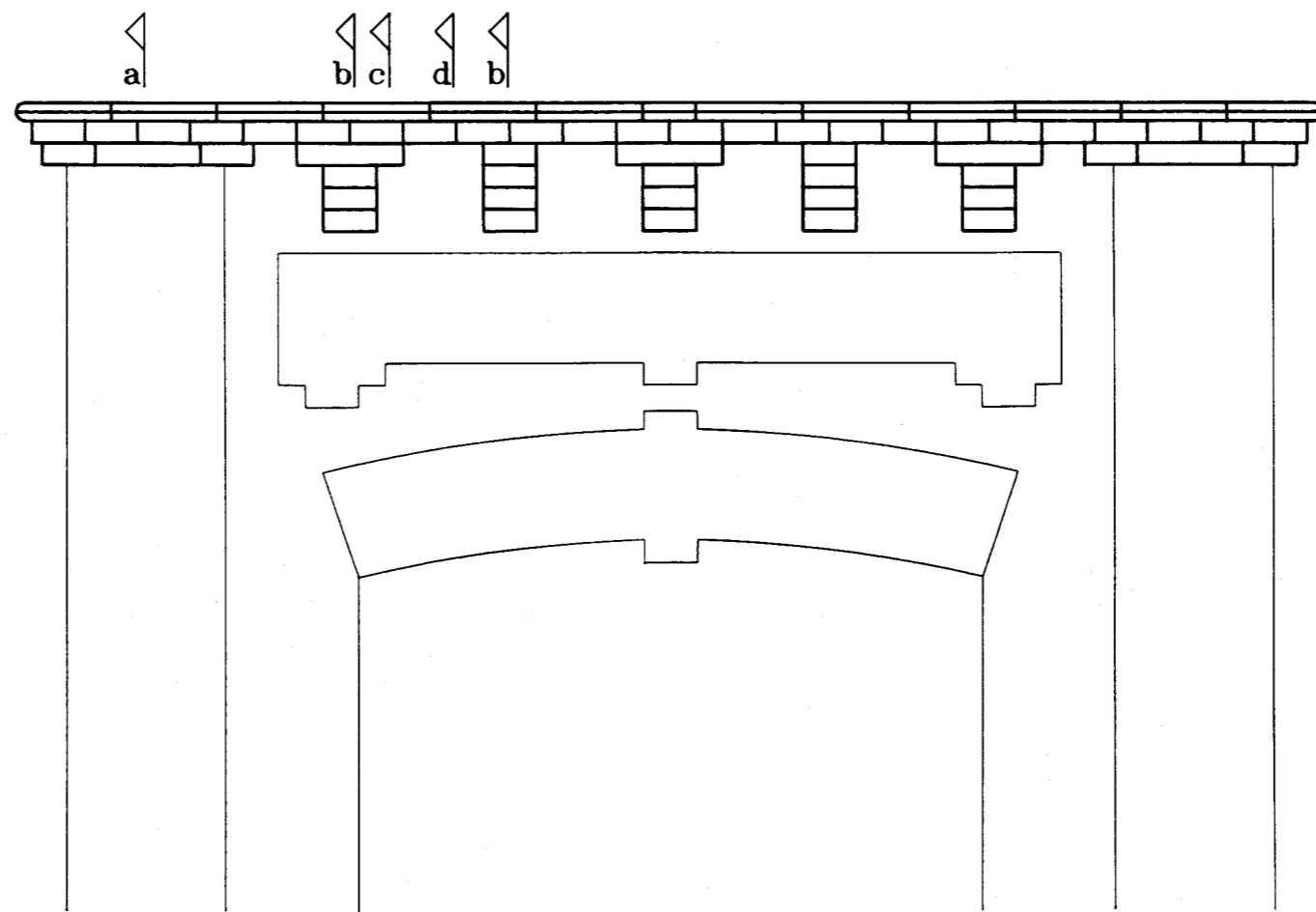
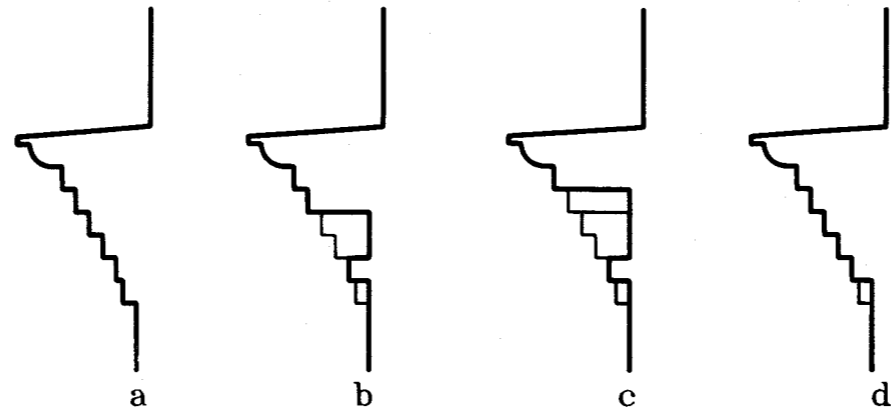
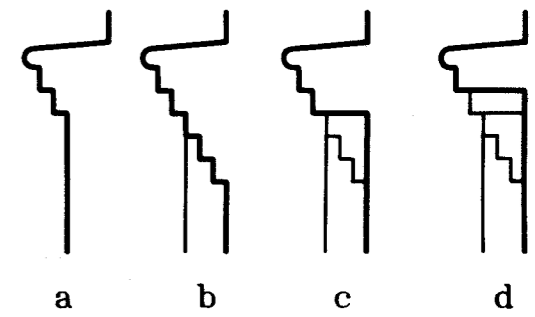

Fig. 6



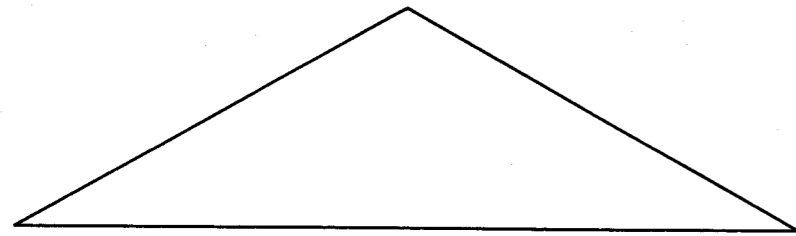

Fig. 1

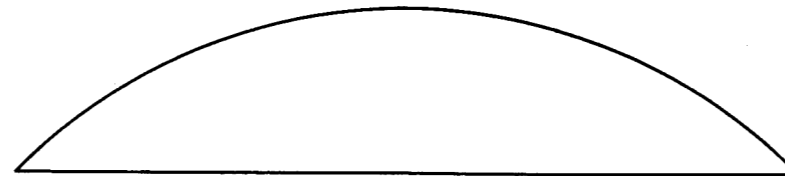

Fig. 5

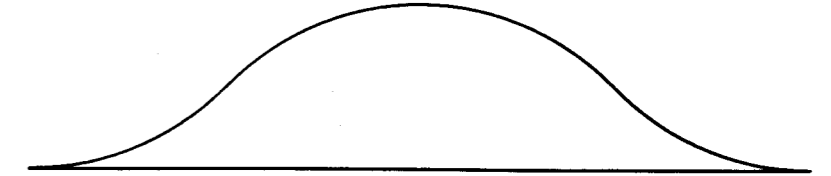

Fig. 8

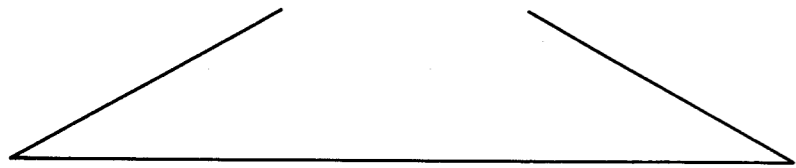

Fig. 2

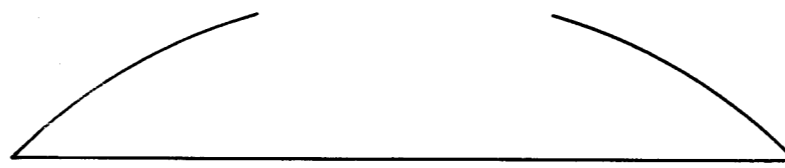

Fig. 6



Fig. 9

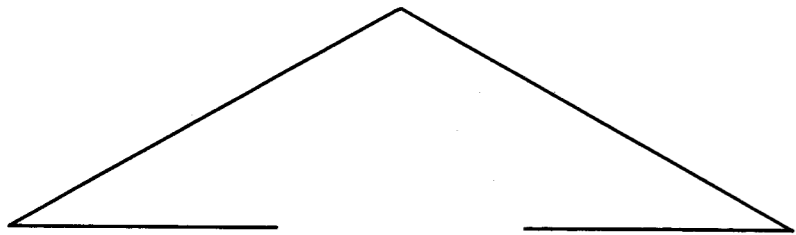

Fig. 3



Fig. 7



Fig. 4

DOSELES Y FRONTONES
FIGURAS DE FRONTONES SINGULARES

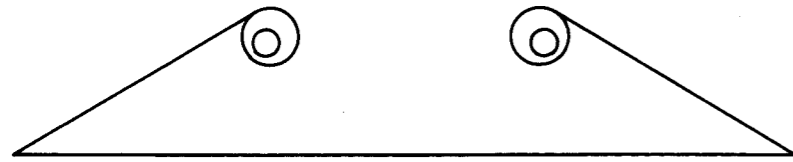

Fig. 1



Fig. 5



Fig. 9

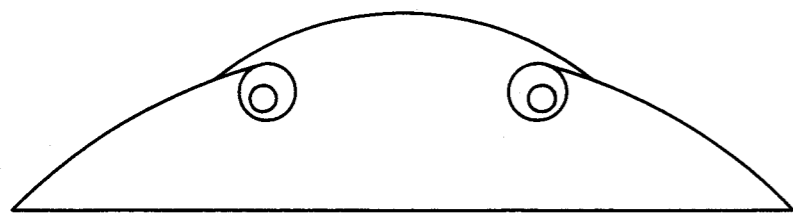

Fig. 2

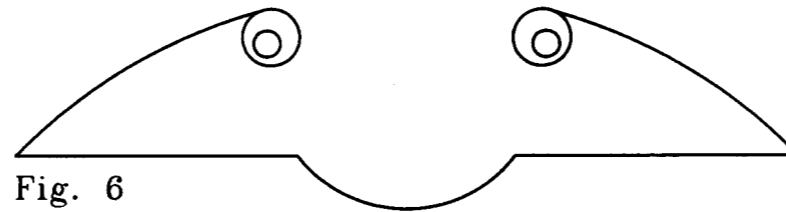

Fig. 6

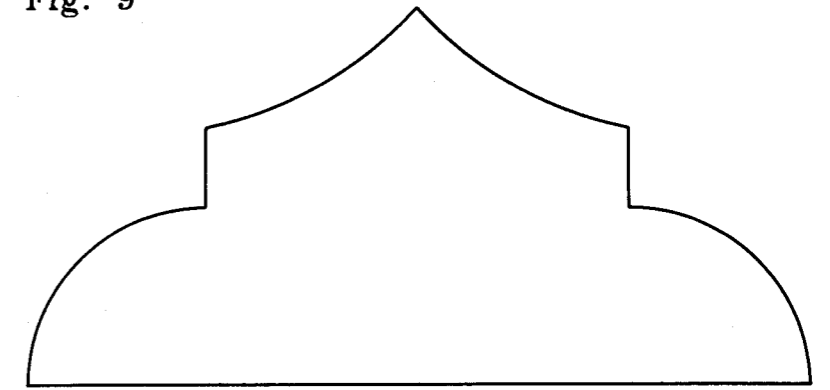

Fig. 10



Fig. 3



Fig. 7

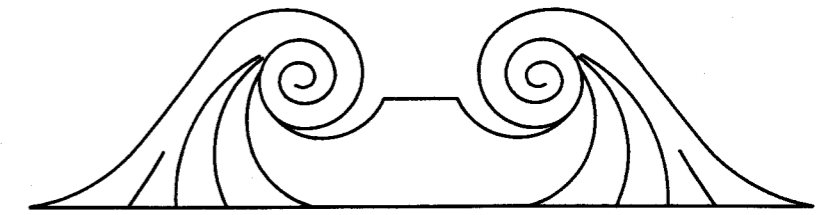

Fig. 11

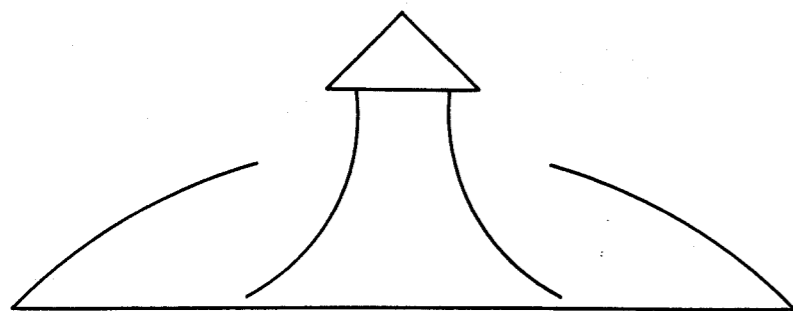

Fig. 4



Fig. 8

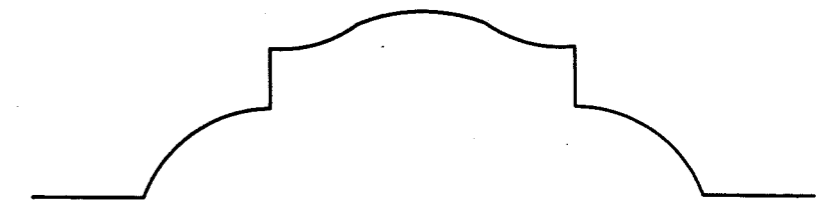

Fig. 12

LAMINA 0406
DOSELES Y FRONTONES
EVOLUCION COMPOSITIVA DE FRONTONES

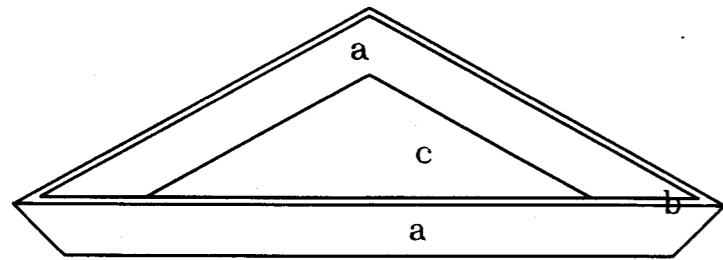

Fig. 1

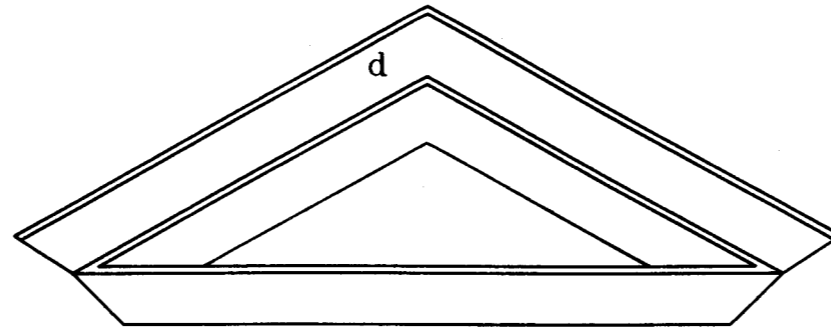

Fig. 2

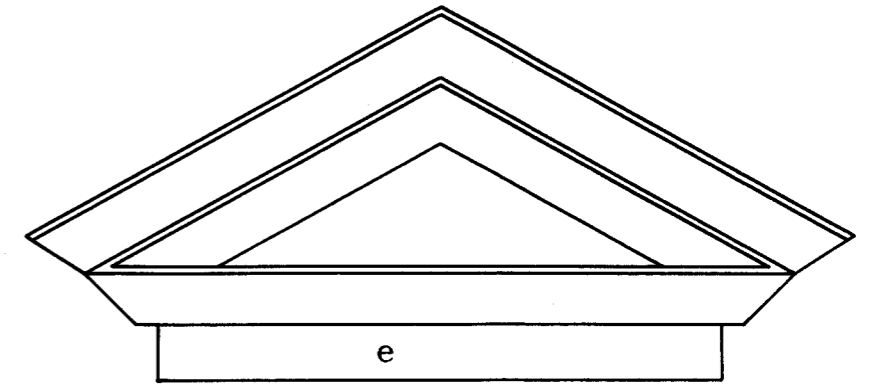

Fig. 3

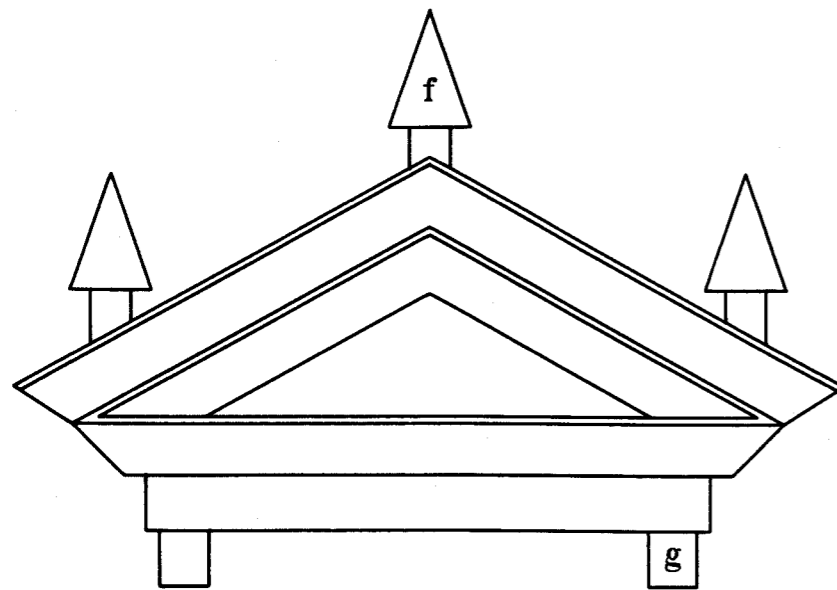

Fig. 4

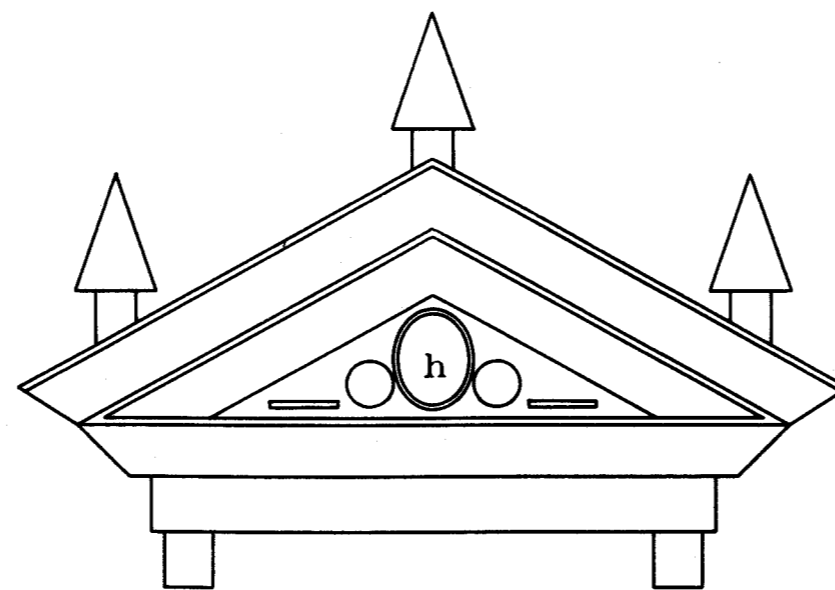

Fig. 5

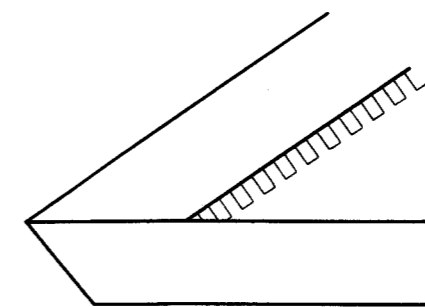

Fig. 6.a

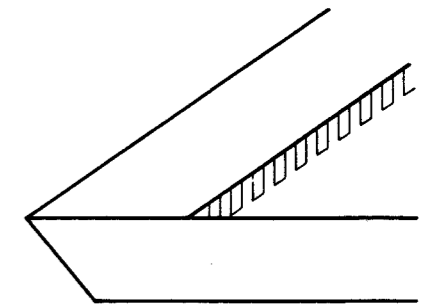

Fig. 6.b

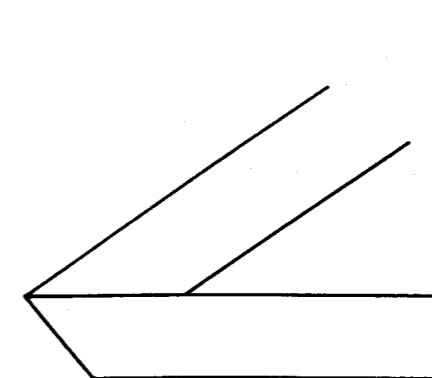

Fig. 7.a

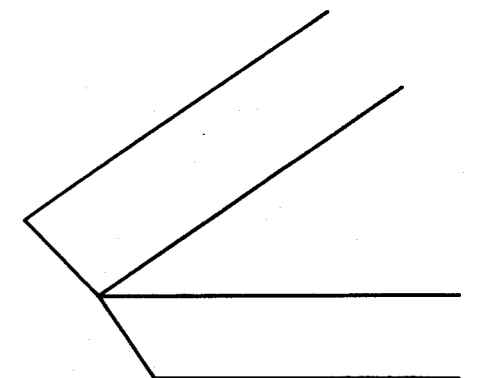

Fig. 7.b

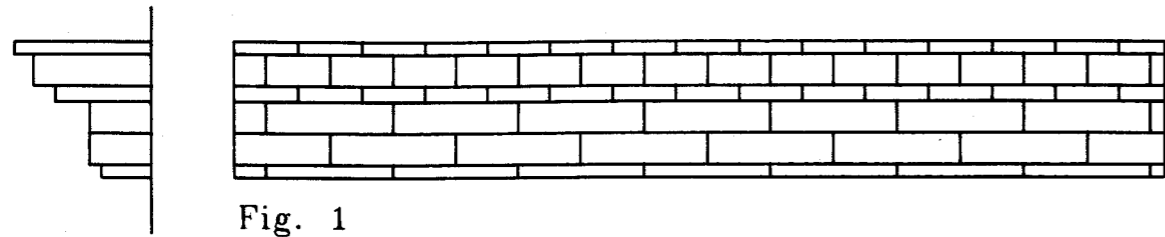

Fig. 1

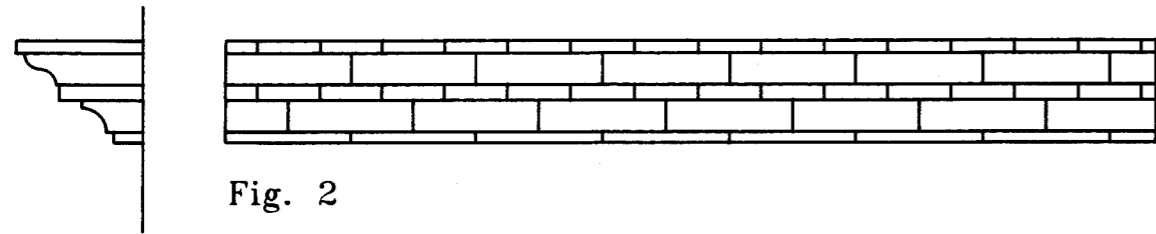

Fig. 2

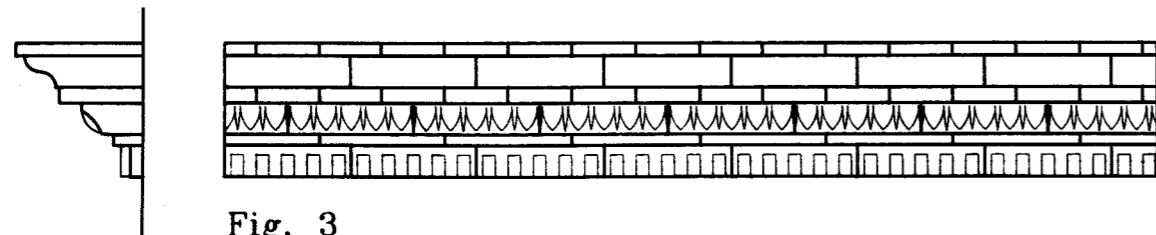

Fig. 3

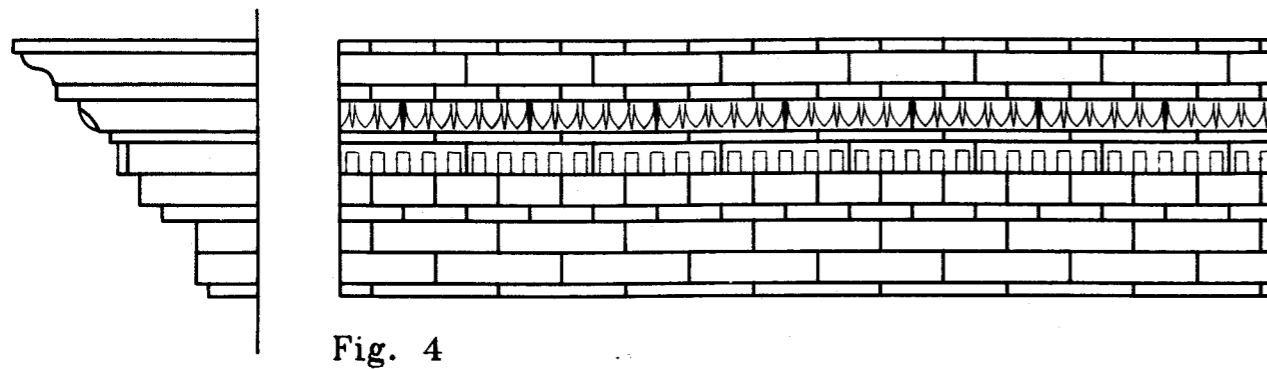

Fig. 4

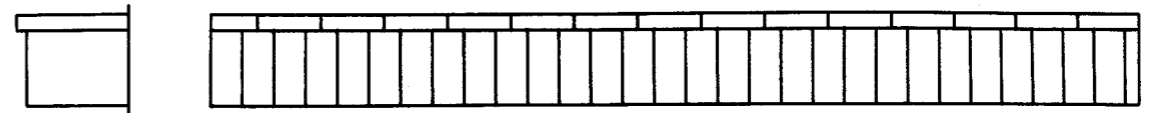

Fig. 5

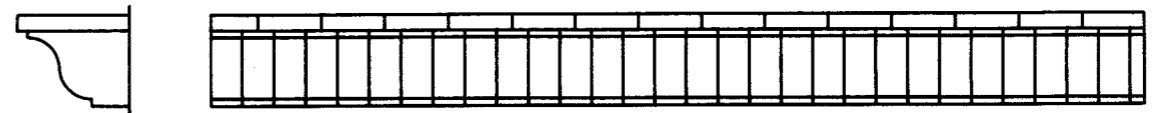

Fig. 6

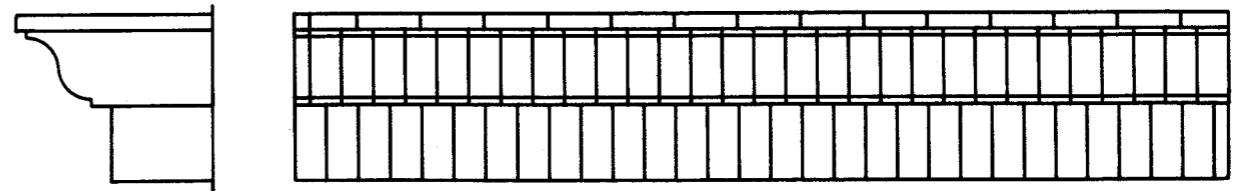

Fig. 7

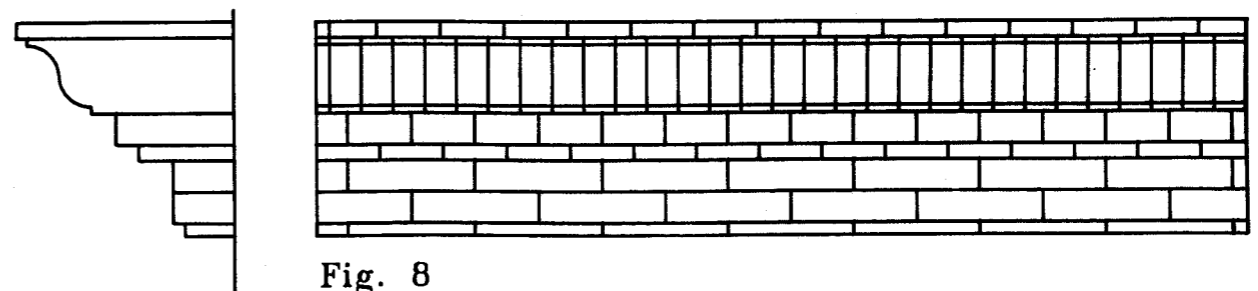

Fig. 8

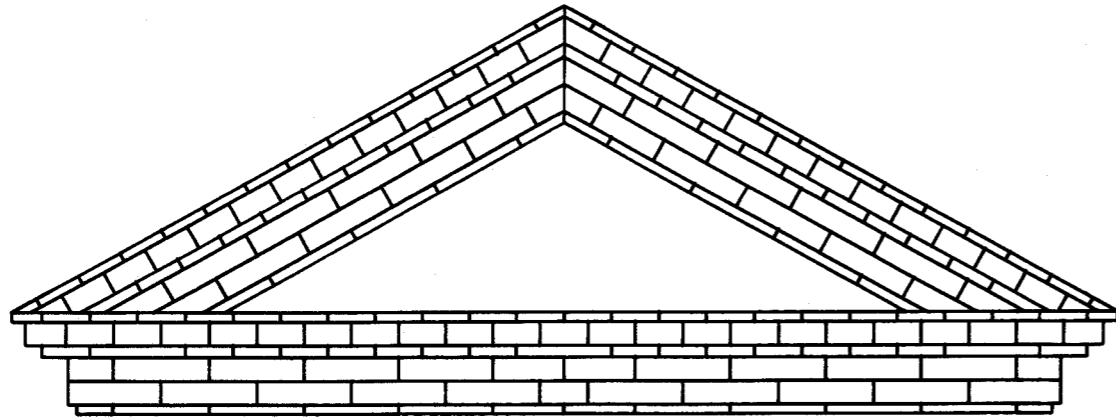

Fig. 1

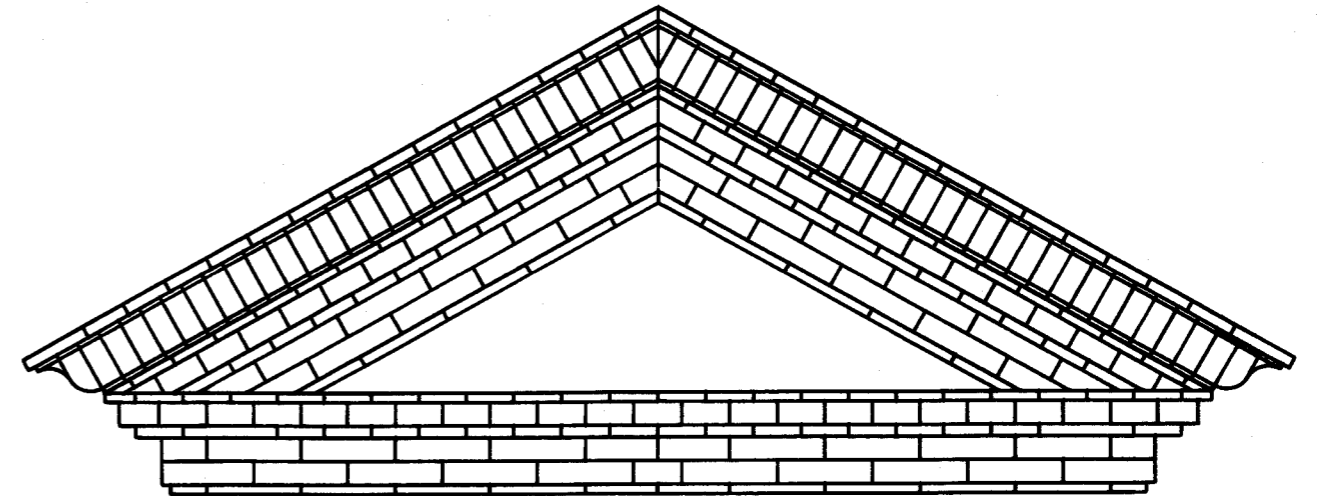

Fig. 2

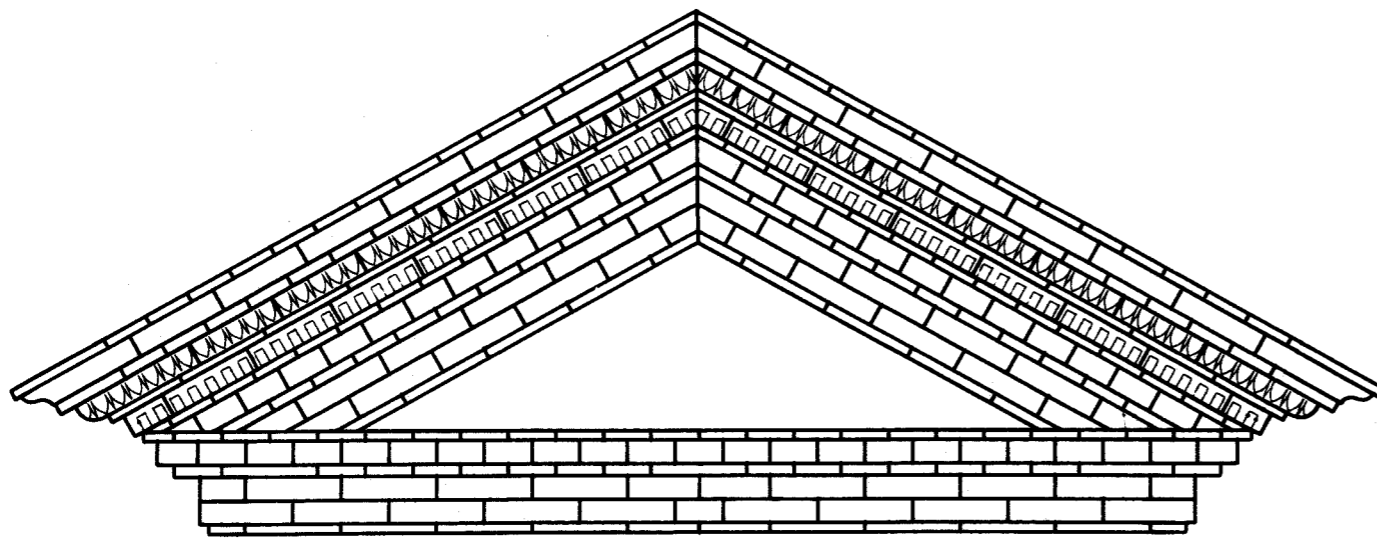

Fig. 3

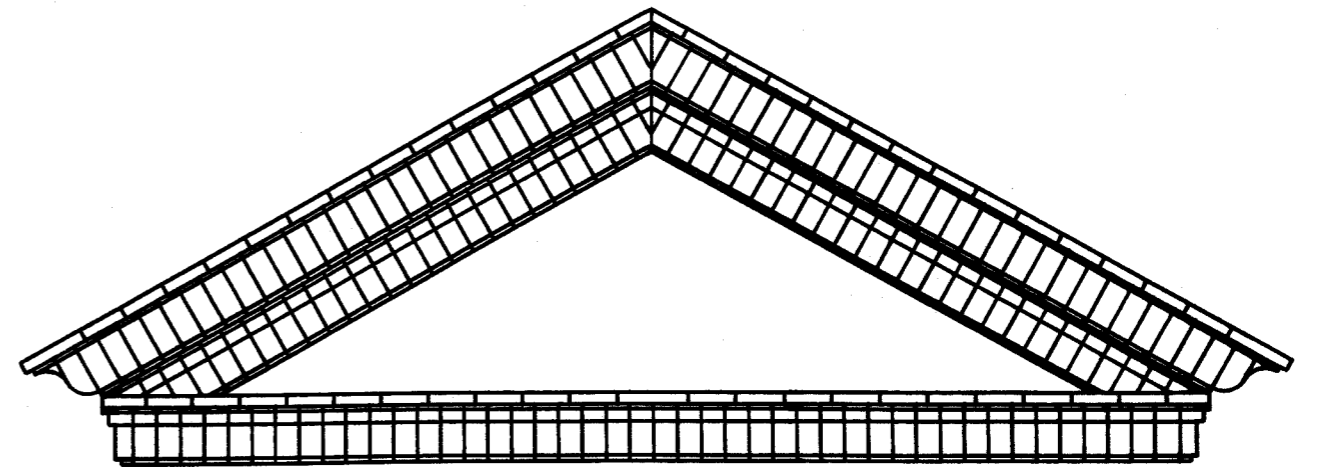

Fig. 4

LAMINA 0501
CERCOS Y OCULOS
CERCOS RECTANGULARES

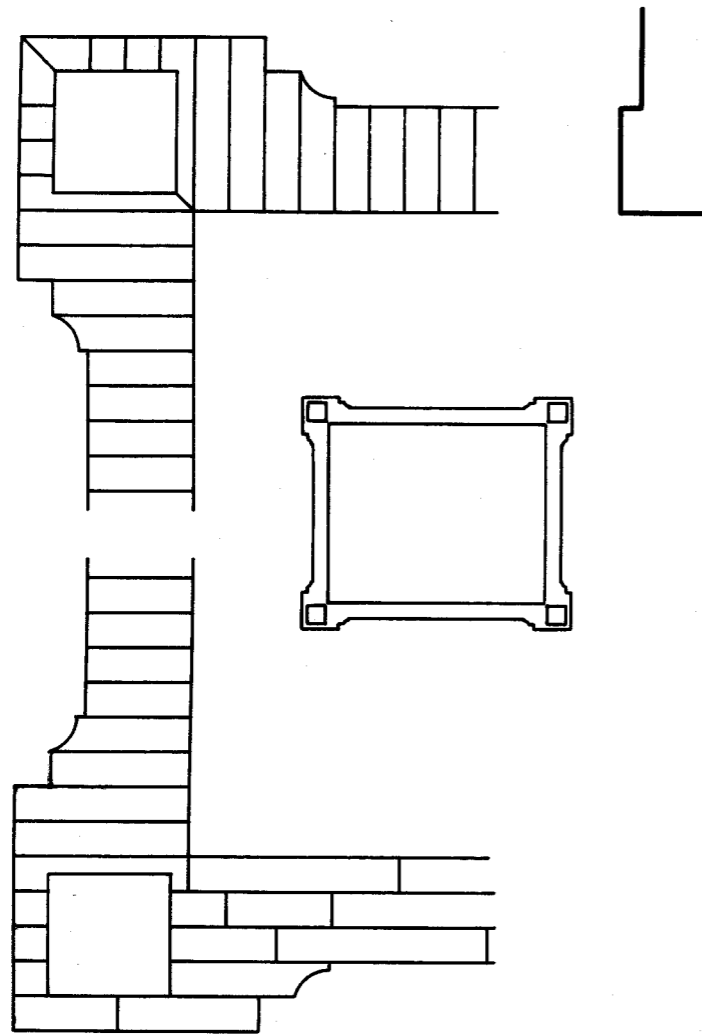

Fig. 1

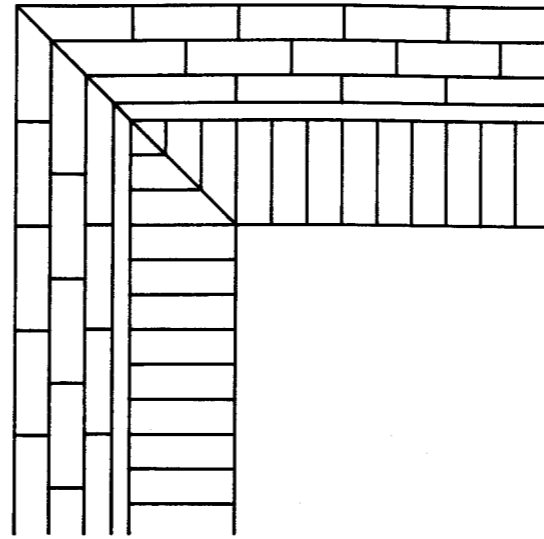
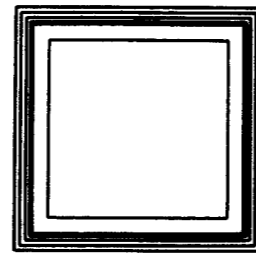

Fig. 2.a

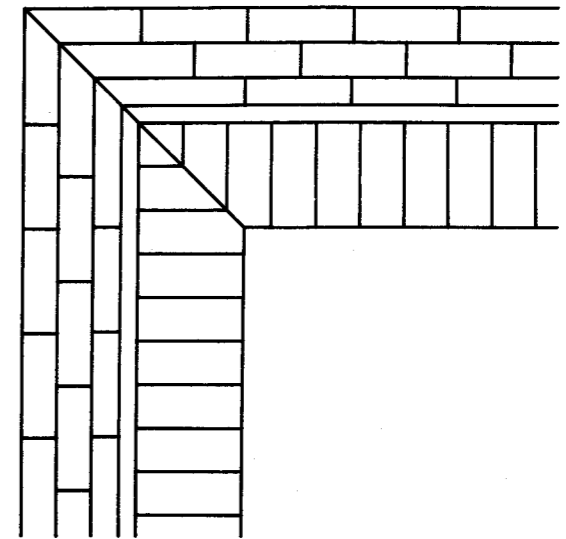

Fig. 2.b

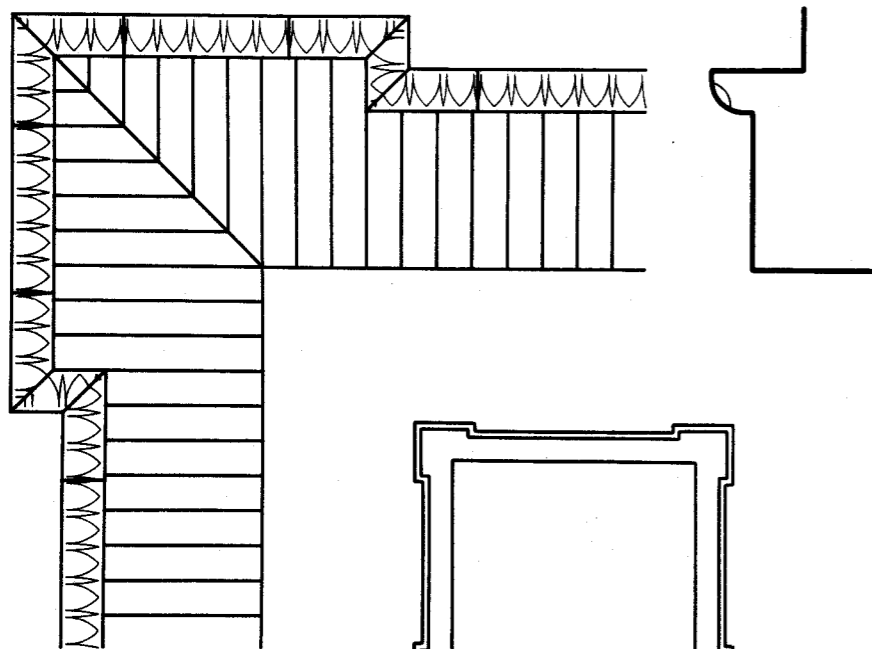

Fig. 3

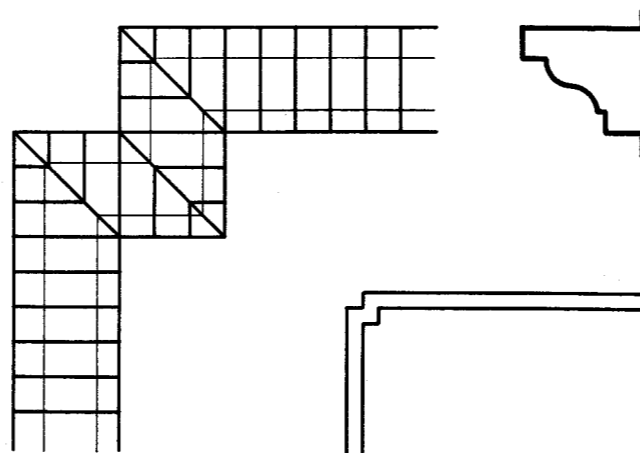

Fig. 4

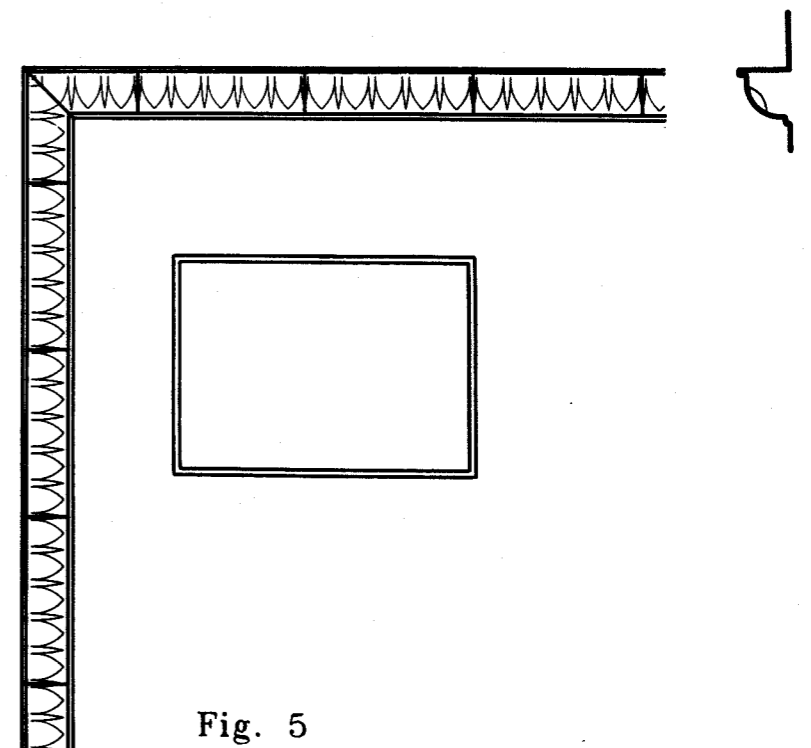
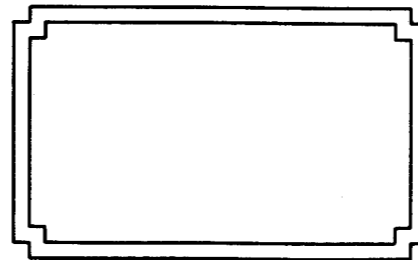

Fig. 5

LAMINA 0502
CERCOS Y OCULOS
APAREJOS Y SECCIONES DE CERCOS CIRCULARES

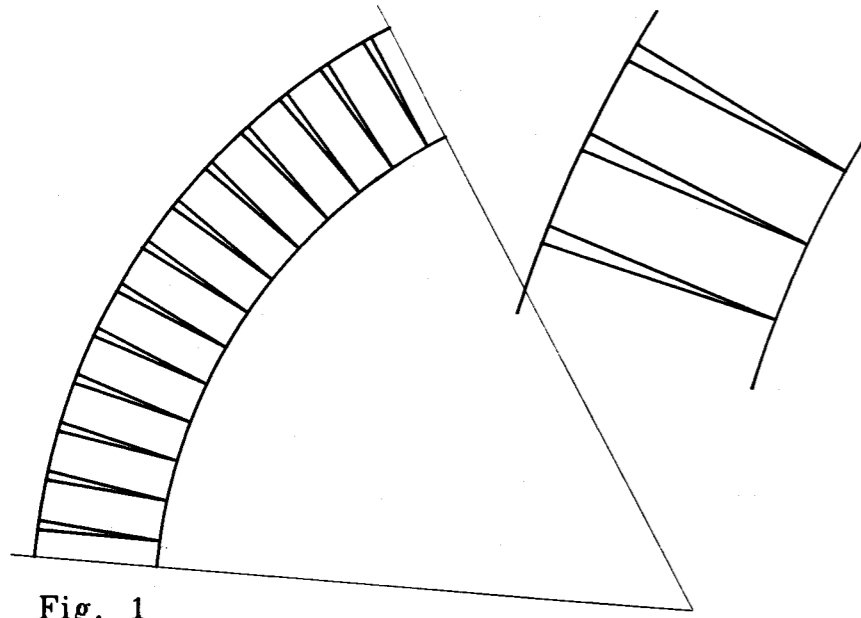

Fig. 1

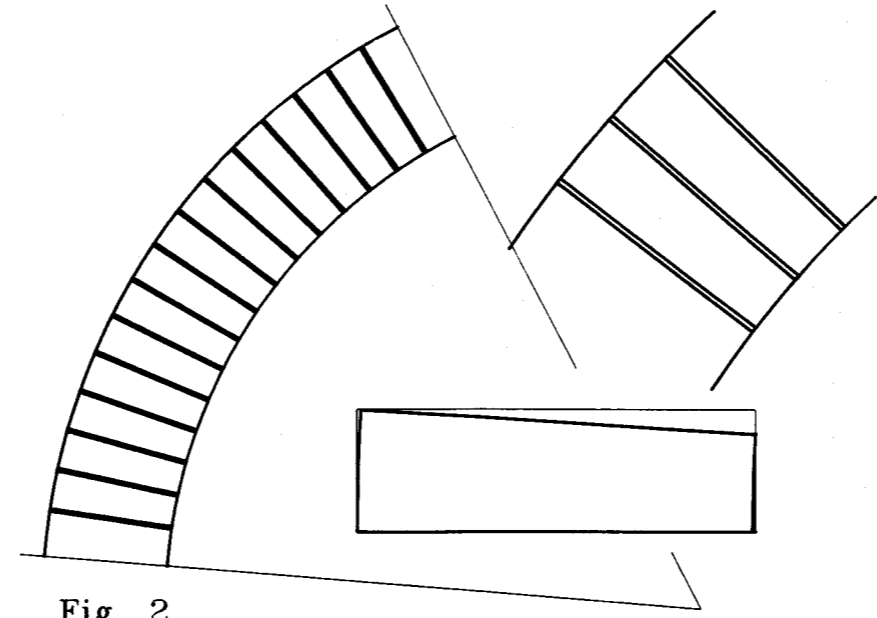

Fig. 2

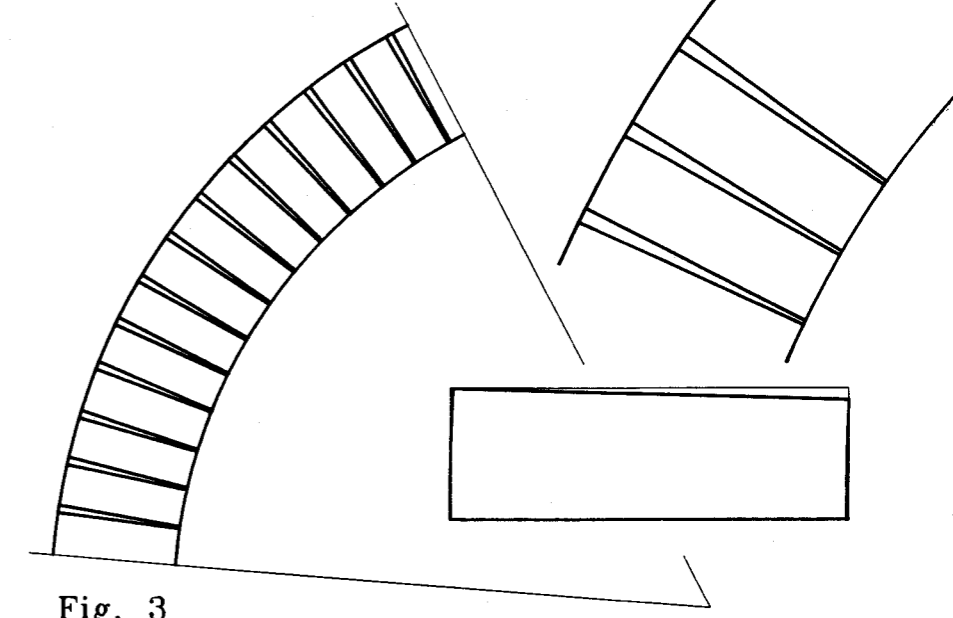

Fig. 3

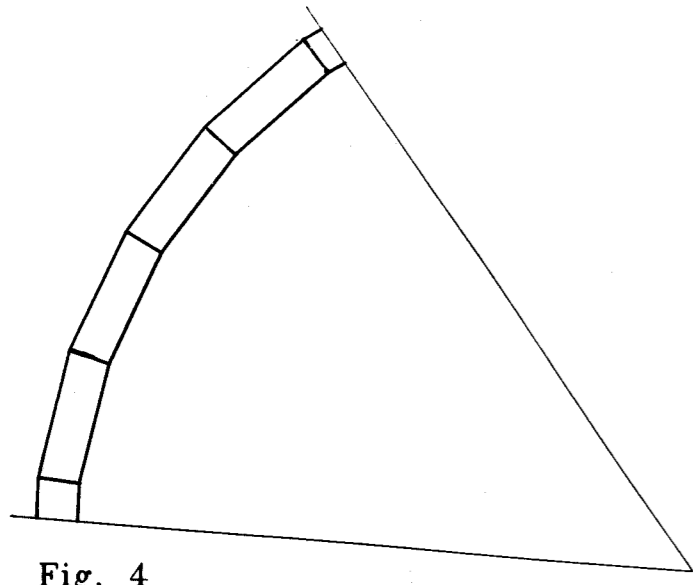

Fig. 4

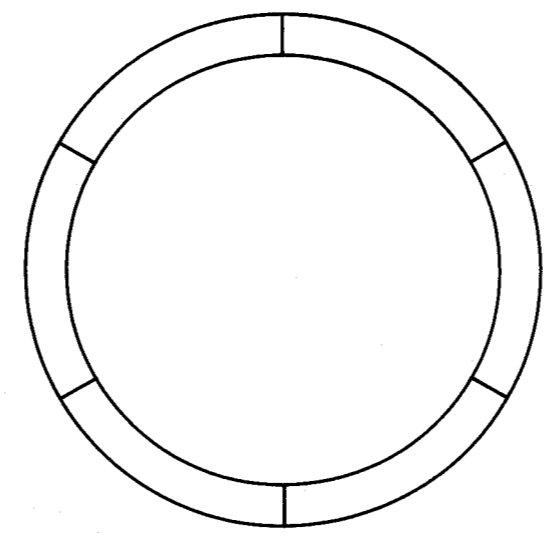

Fig. 5

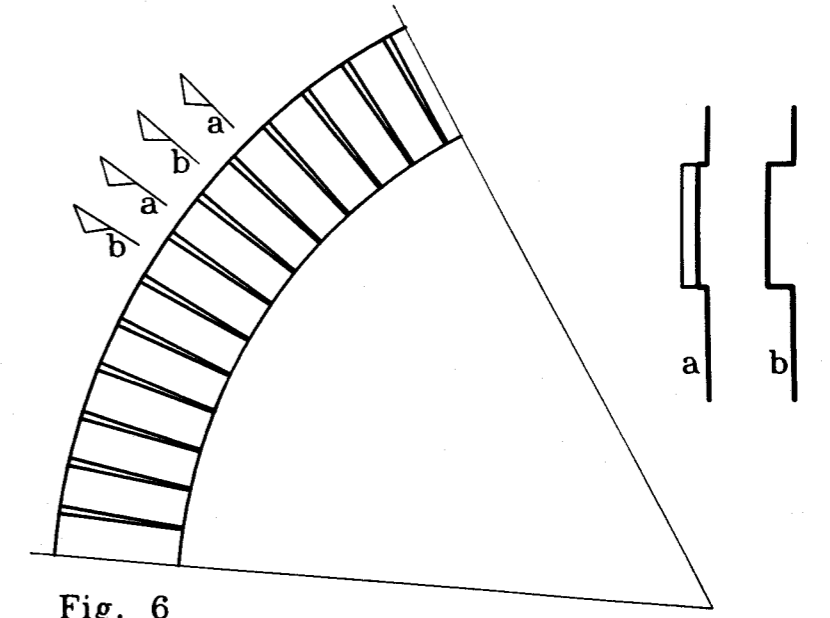

Fig. 6

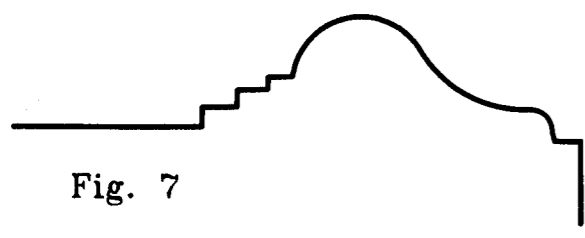

Fig. 7

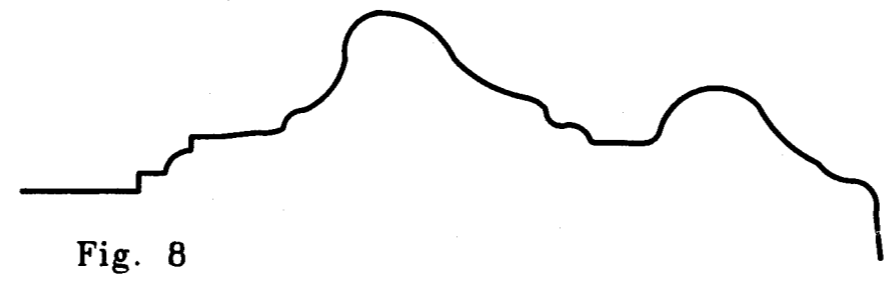

Fig. 8

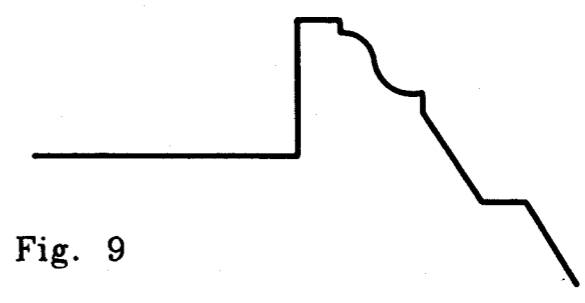
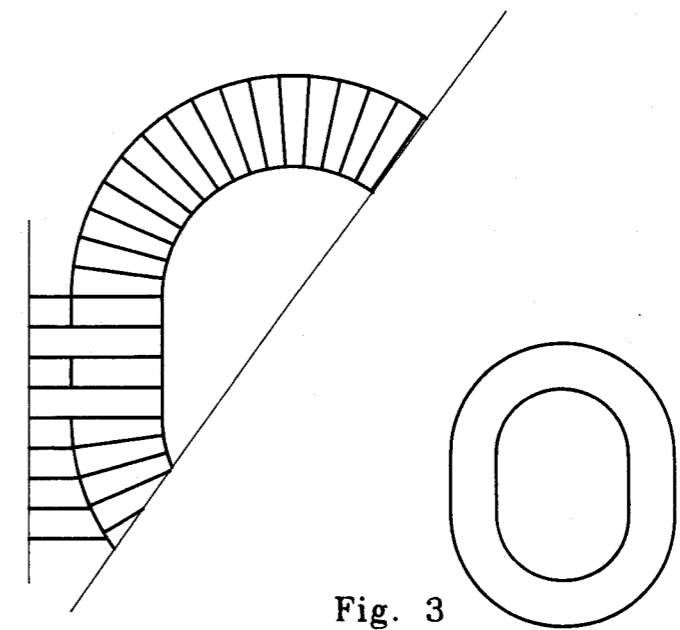
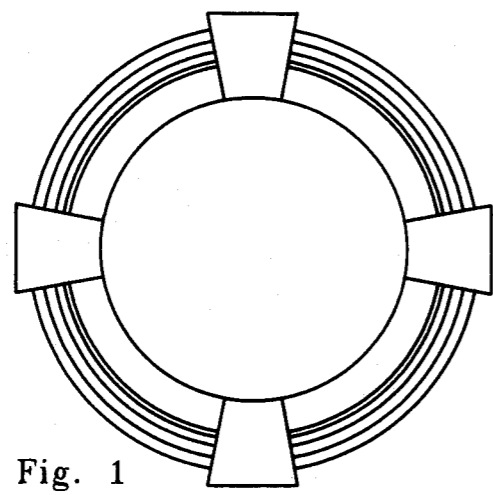
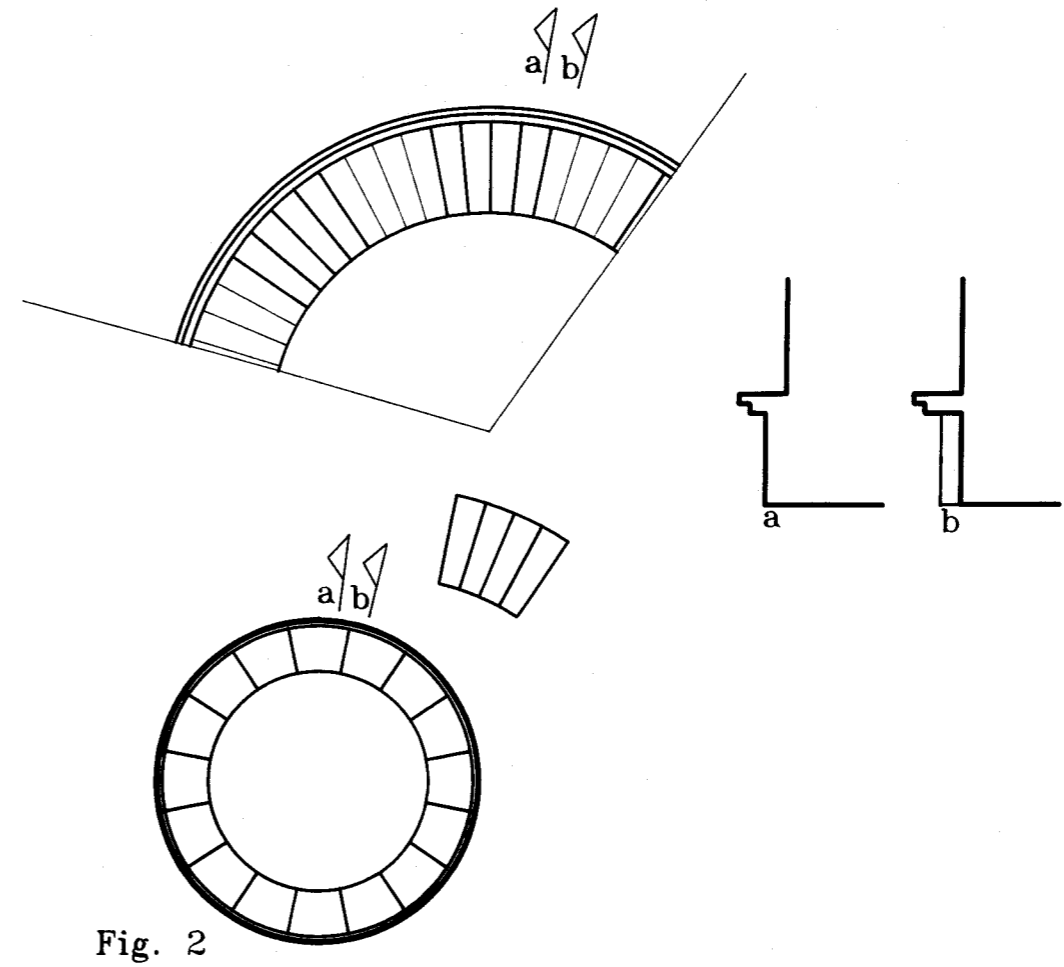
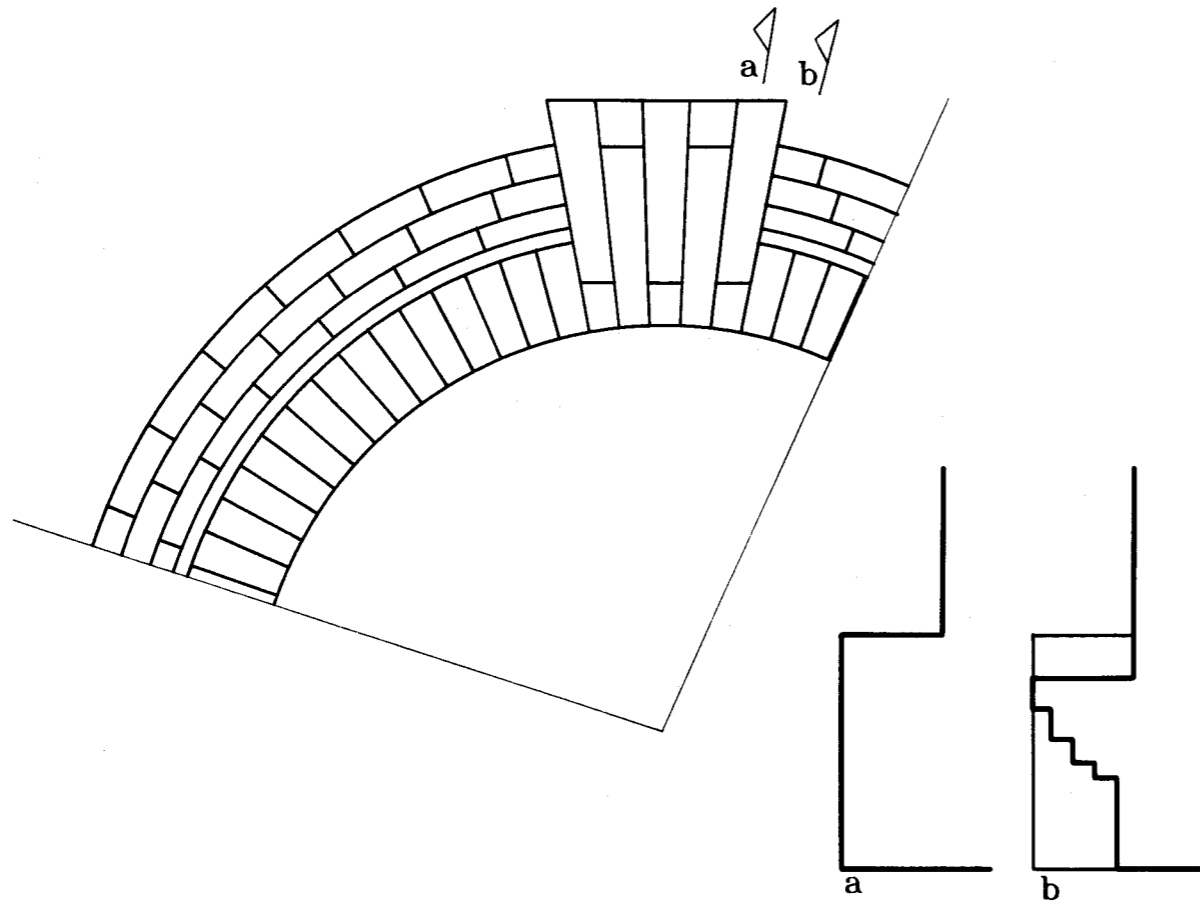

Fig. 9



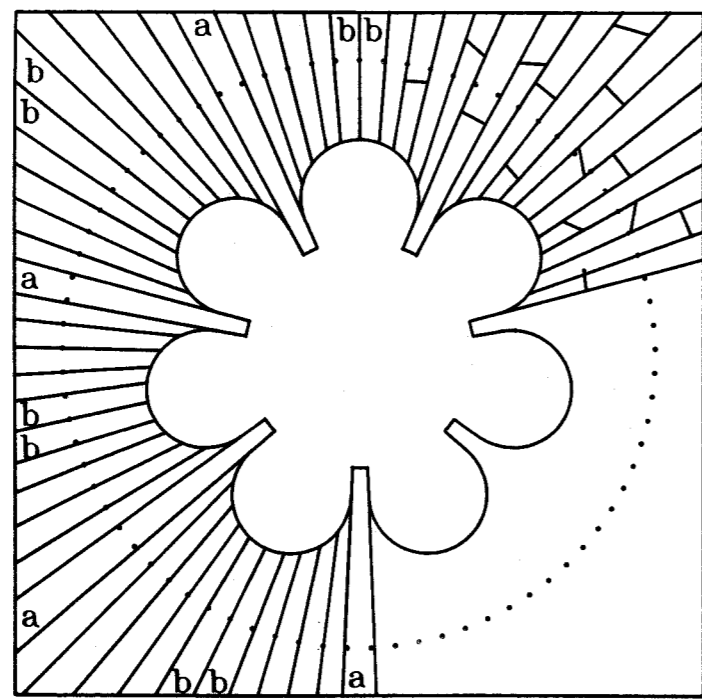
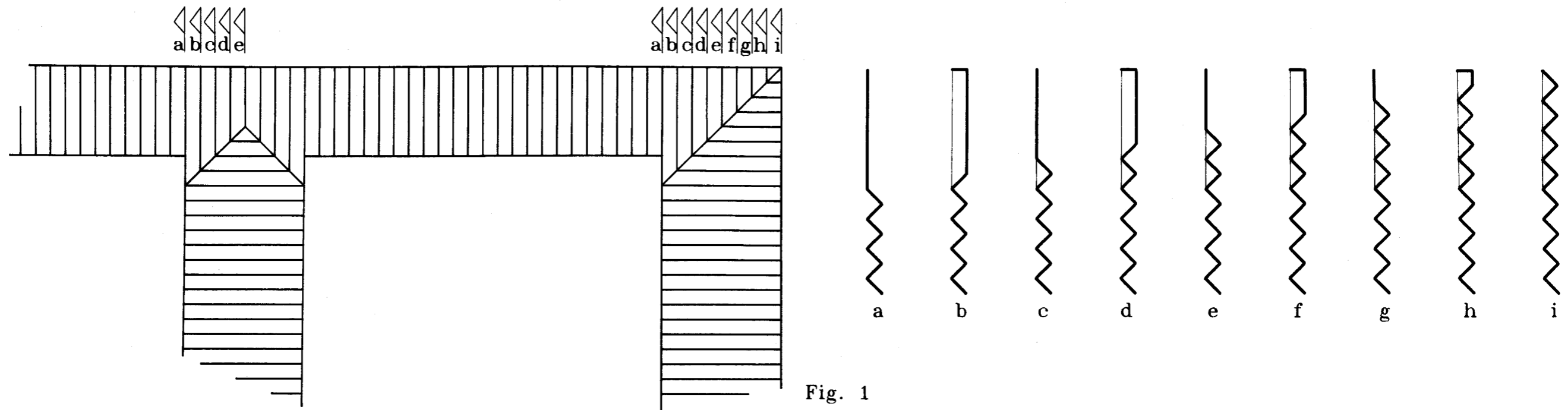

Fig. 2

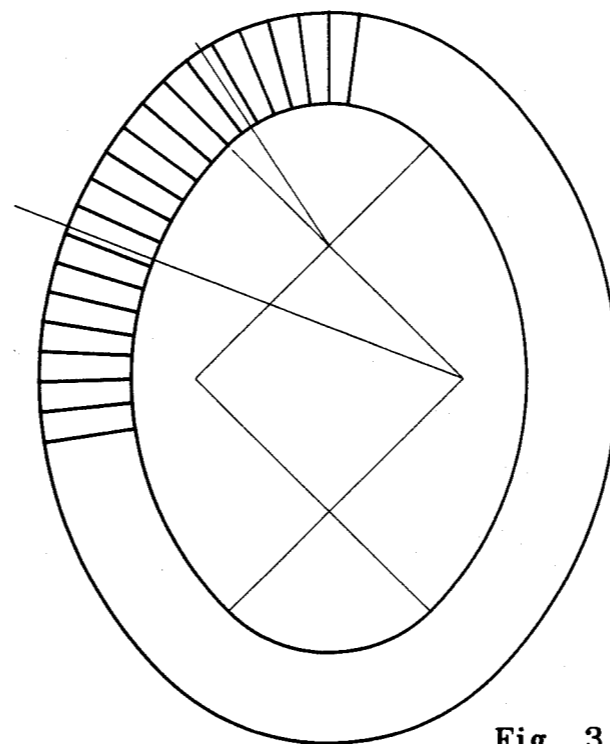

Fig. 3.a

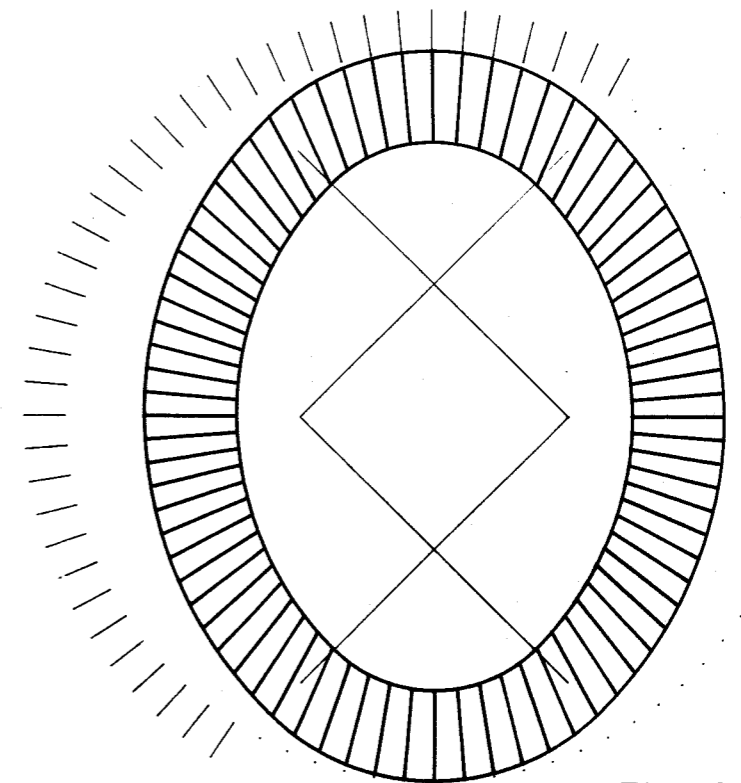

Fig. 3.b

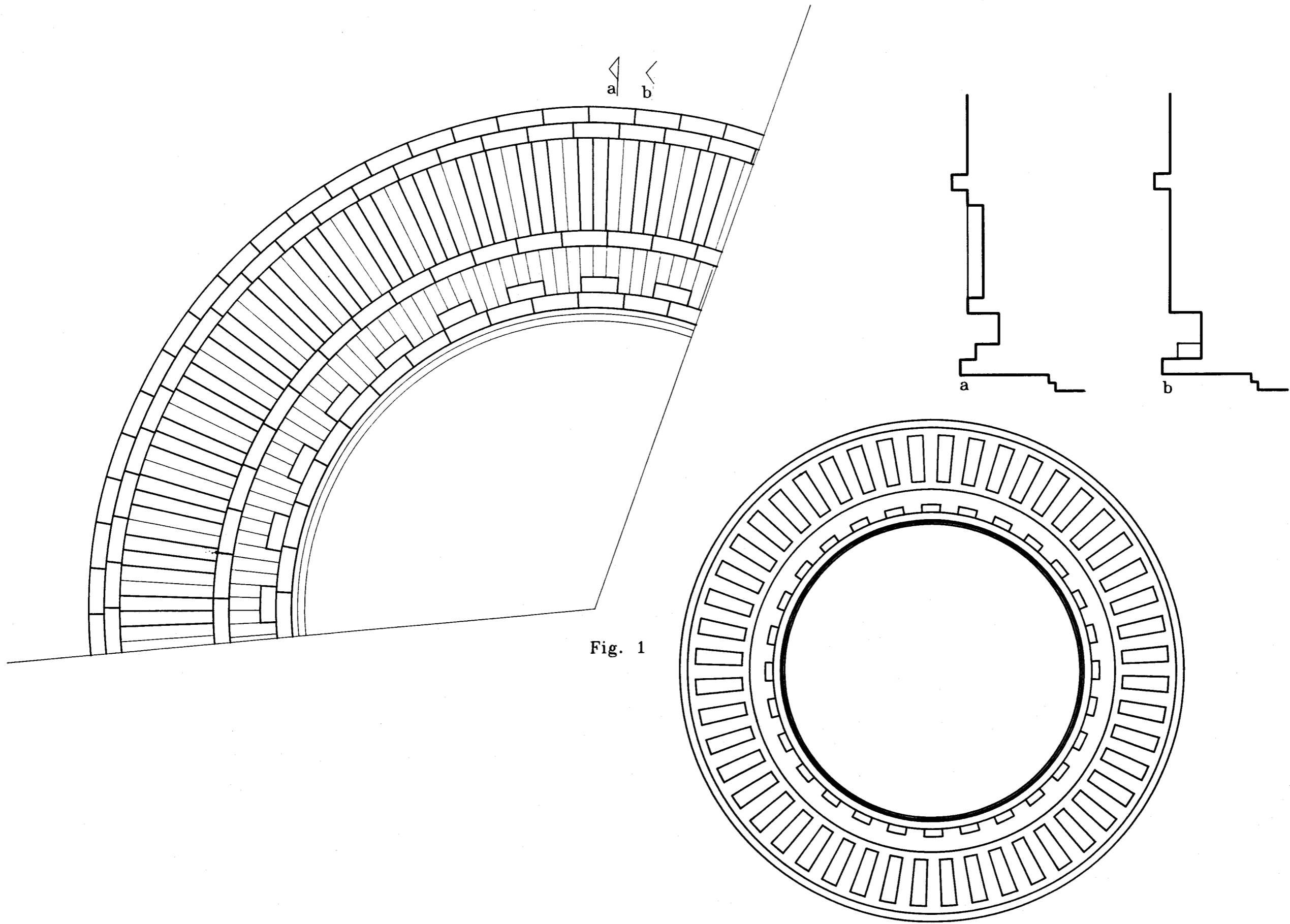

Fig. 1

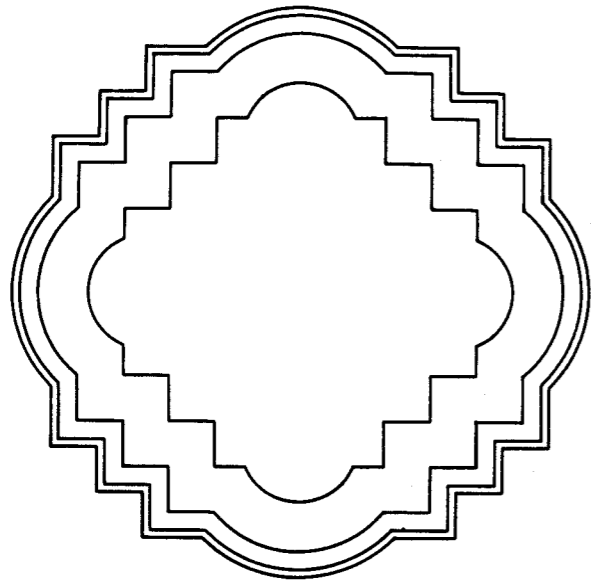

Fig. 1

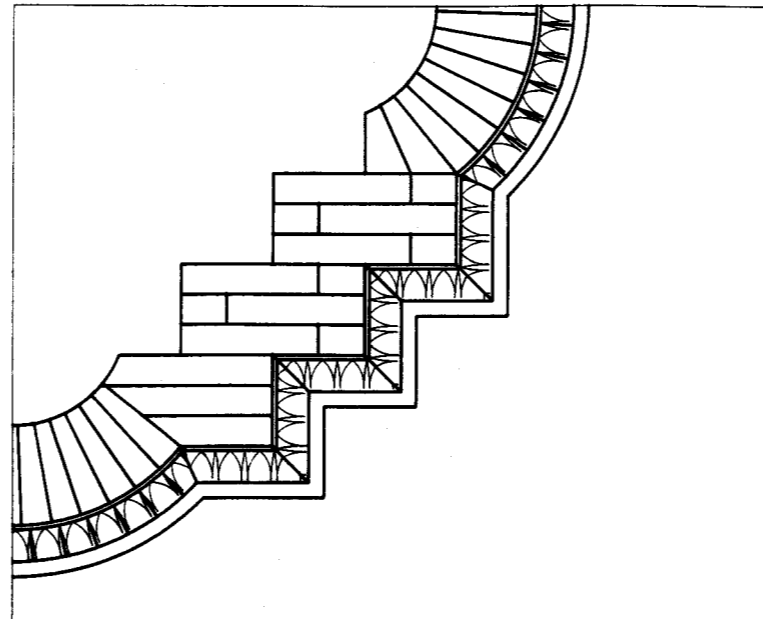

Fig. 1.a

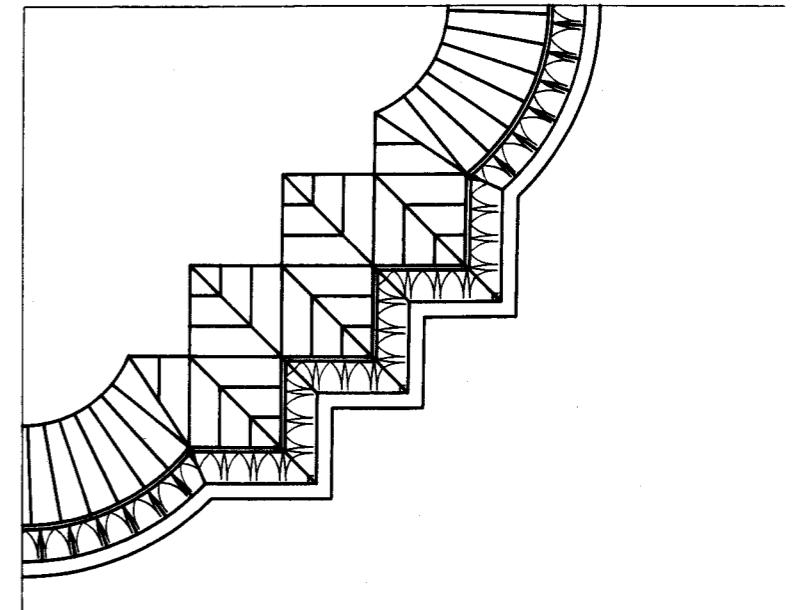

Fig. 1.b

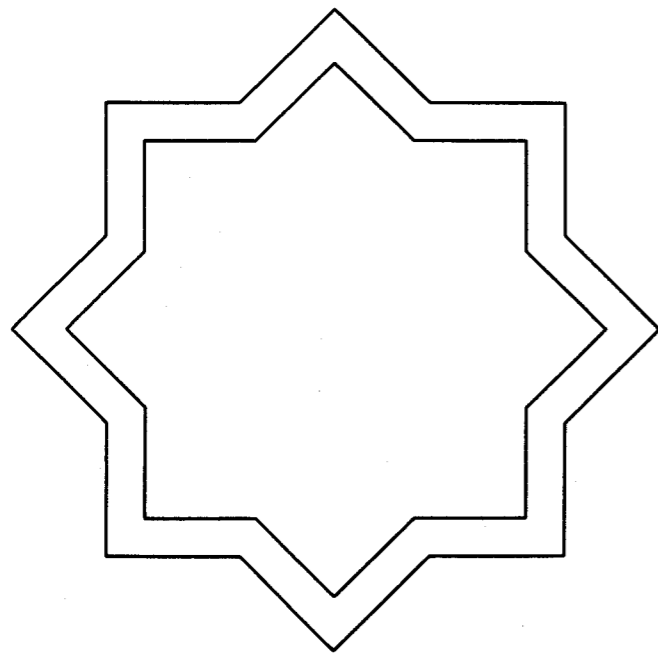

Fig. 2

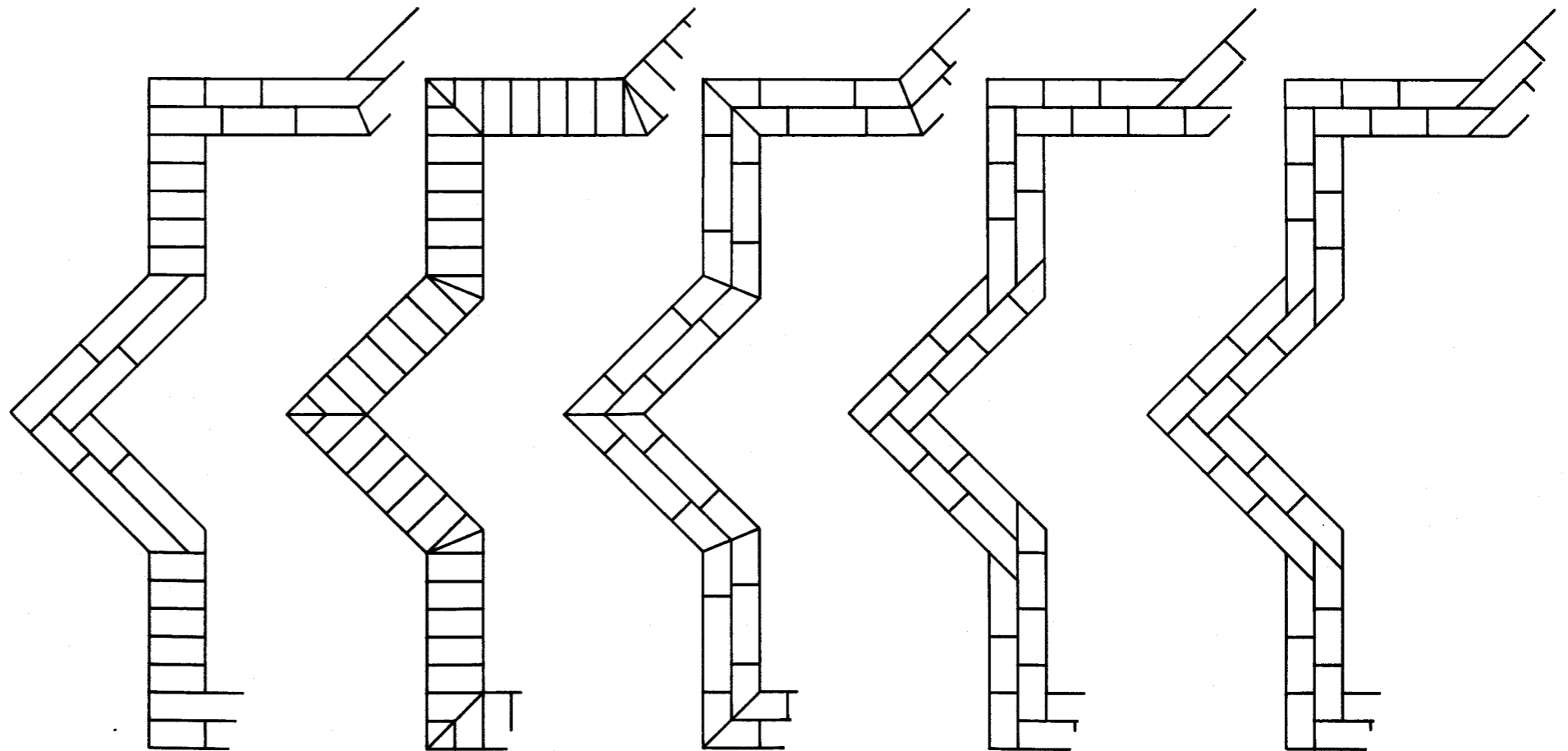

Fig. 2.a

Fig. 2.b

Fig. 2.c

Fig. 2.d

Fig. 2.e

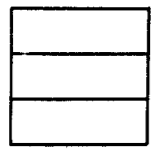

Fig. 1

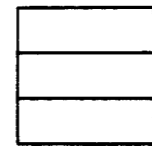
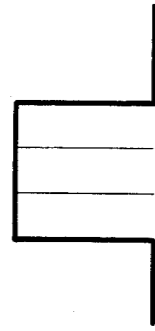

Fig. 2

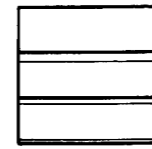
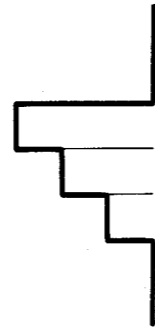

Fig. 3

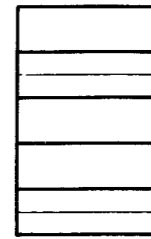

Fig. 4

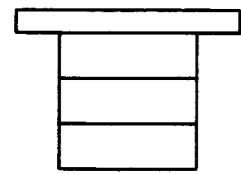
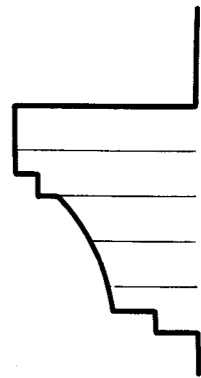

Fig. 5

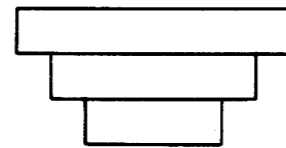
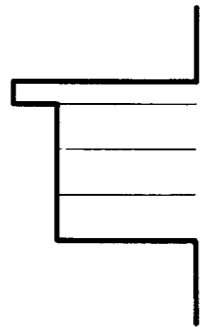

Fig. 6

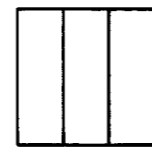
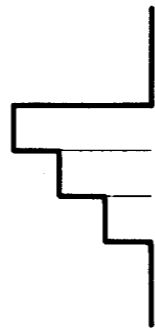

Fig. 7

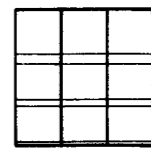
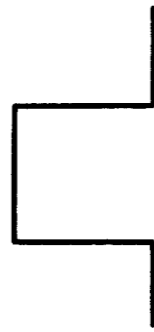

Fig. 8

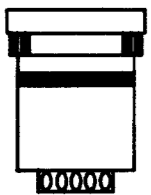

Fig. 9

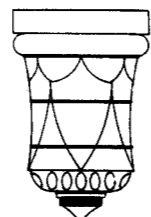
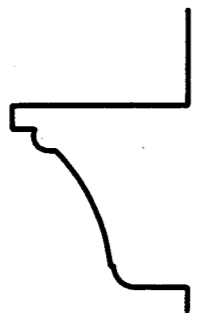

Fig. 10

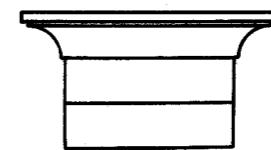
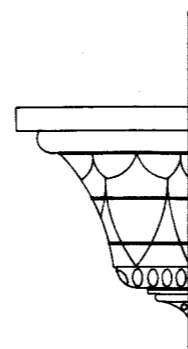
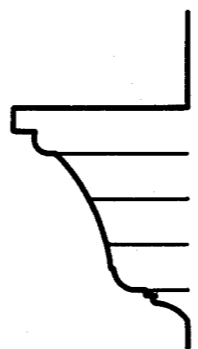
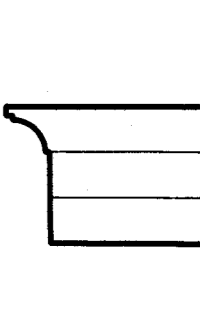
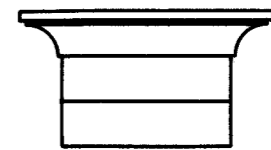

Fig. 11



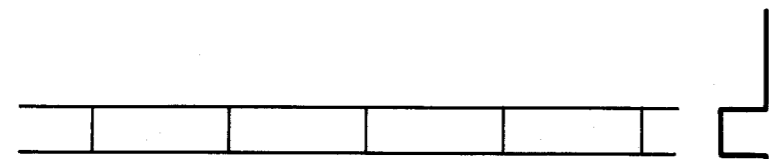

Fig. 1.a

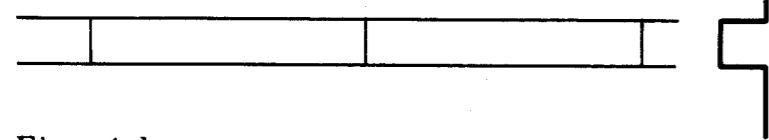

Fig. 1.b

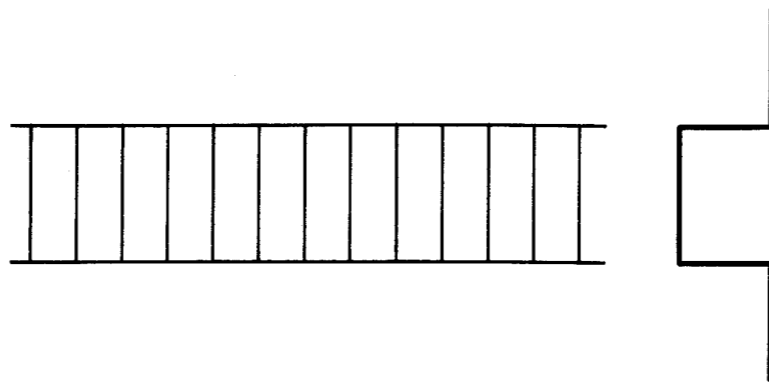

Fig. 2

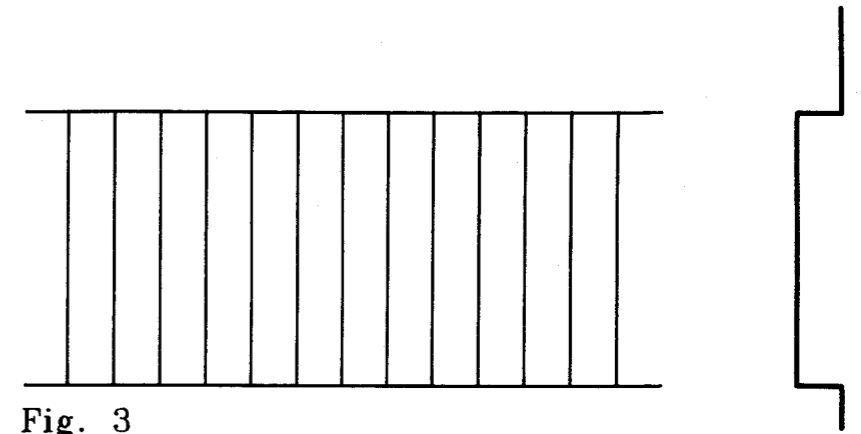

Fig. 3

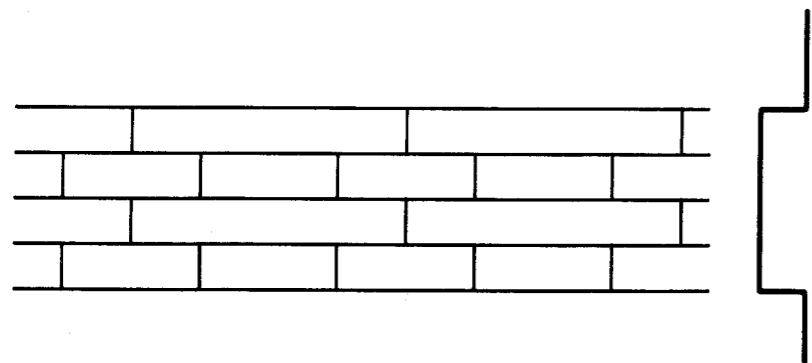

Fig. 4

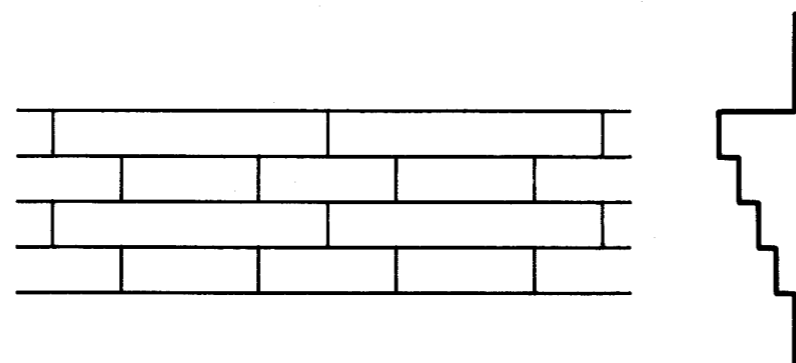

Fig. 5

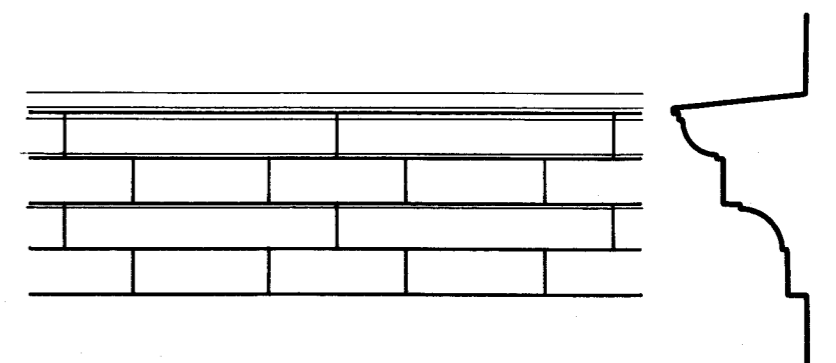

Fig. 6

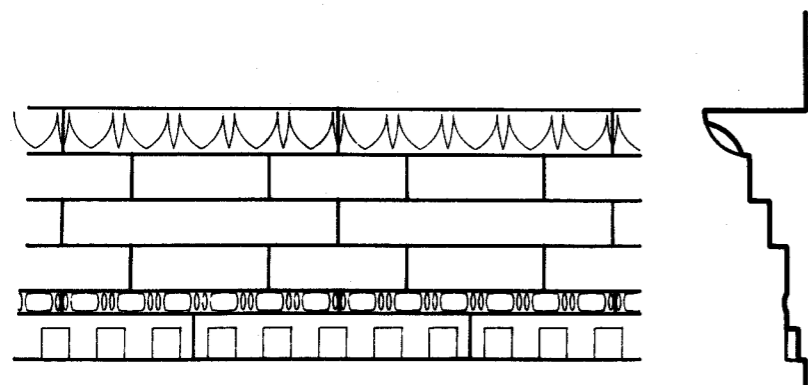

Fig. 7

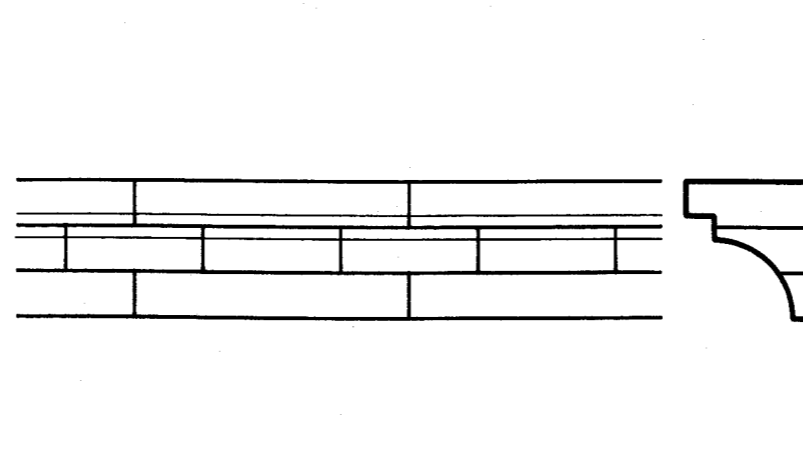

Fig. 8

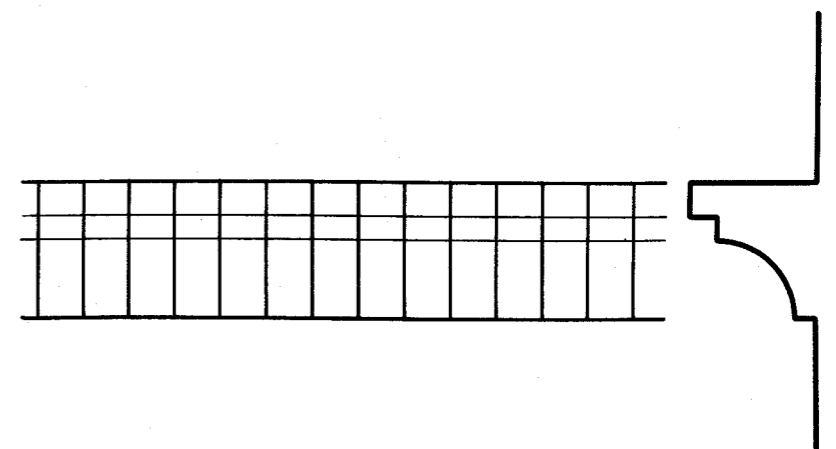
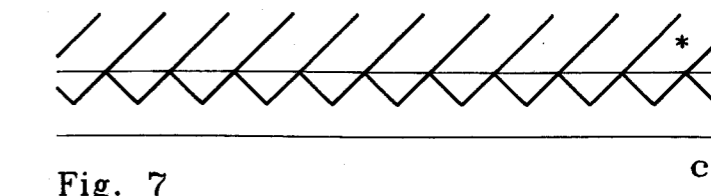
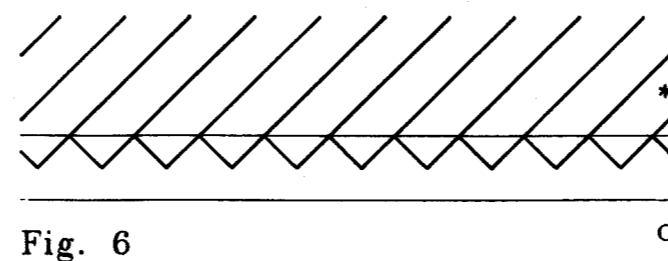
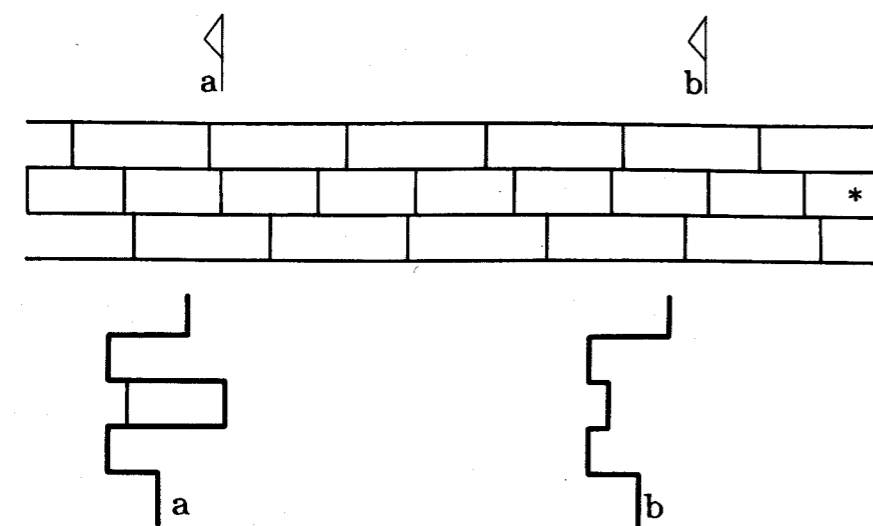
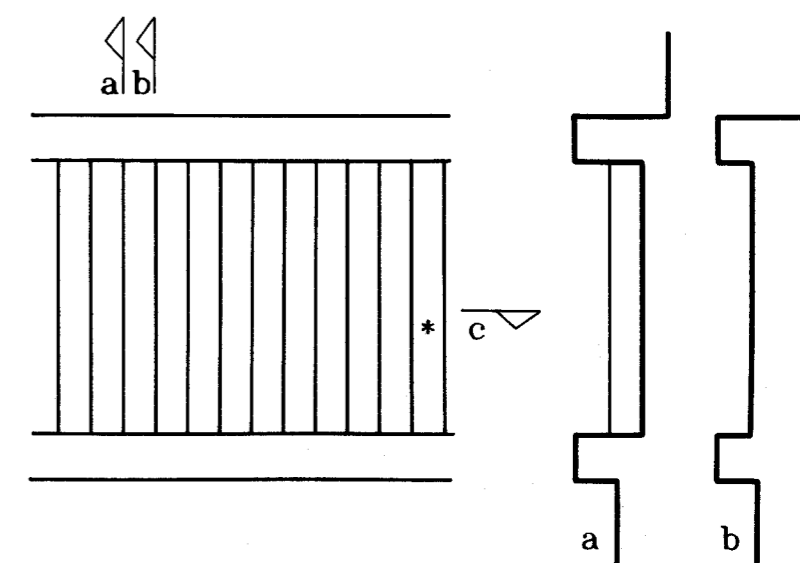
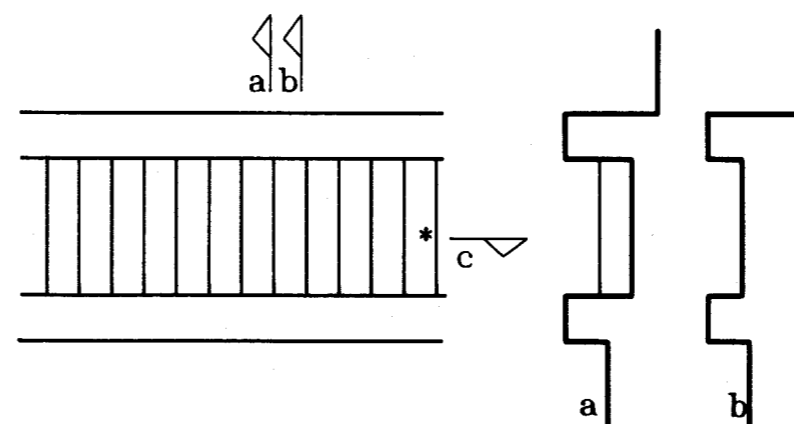
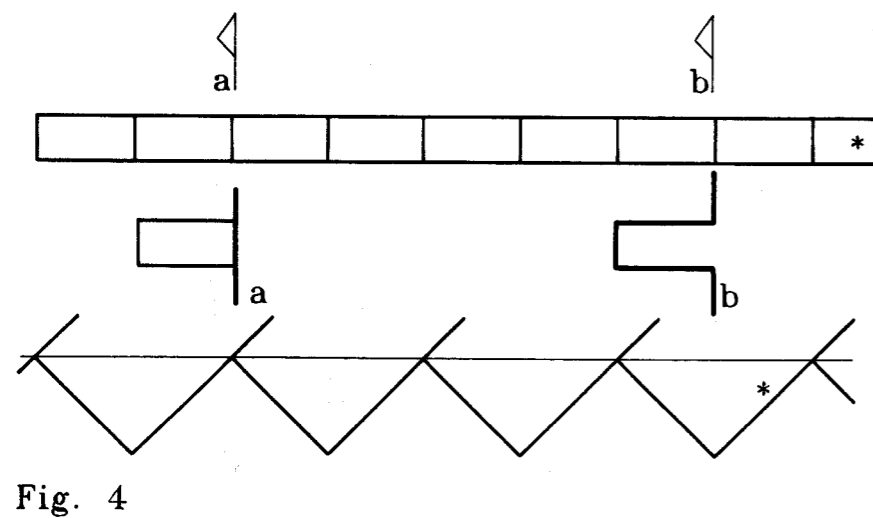
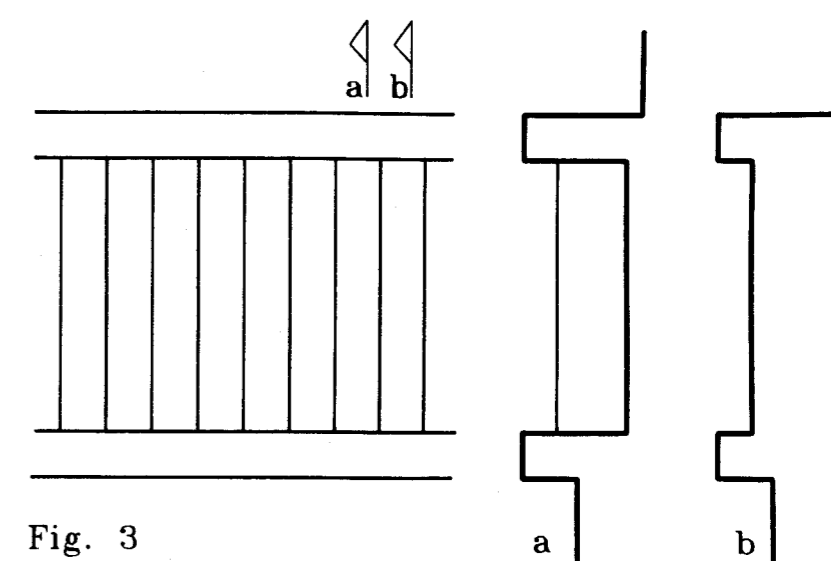
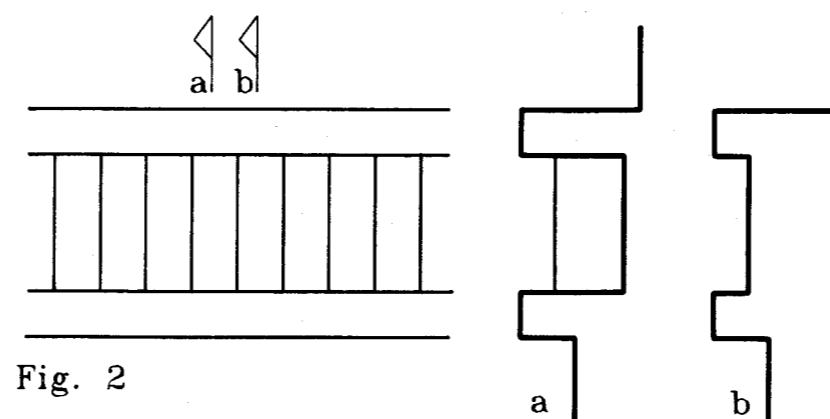
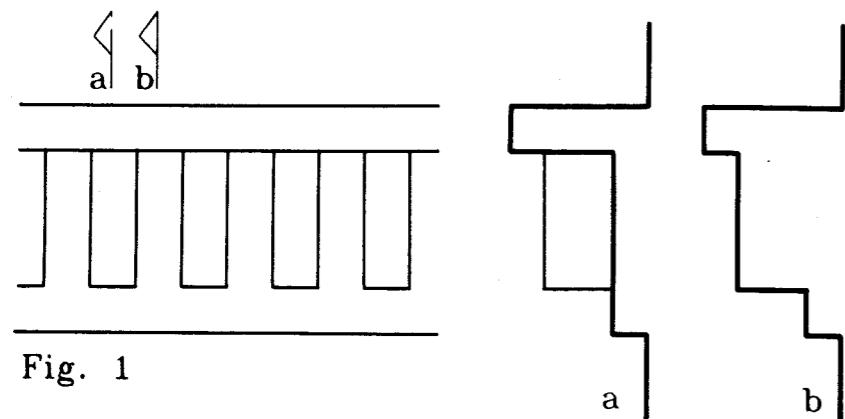

Fig. 9



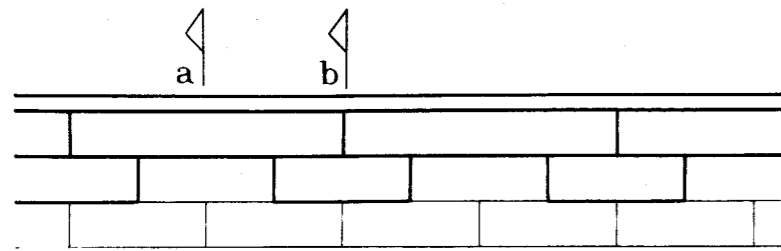

Fig. 1

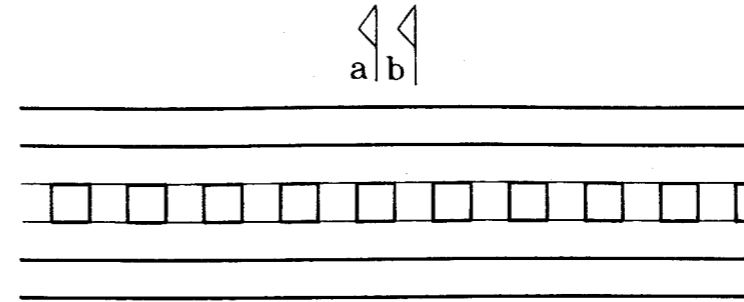
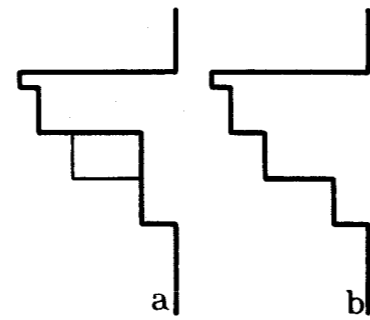

Fig. 2

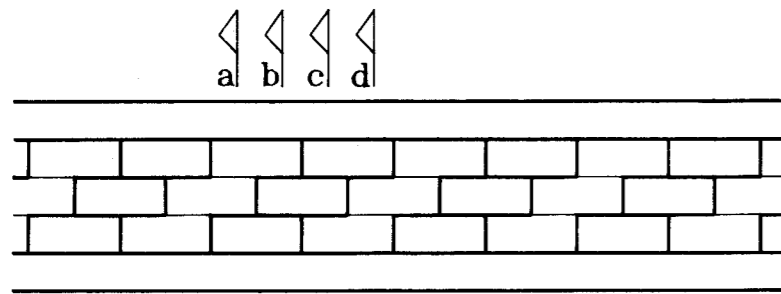
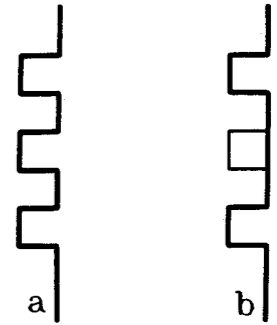

Fig. 3

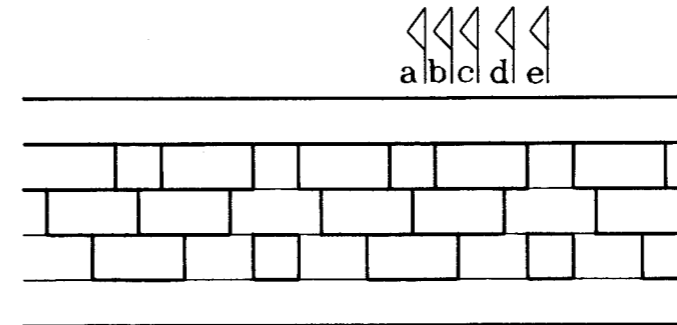
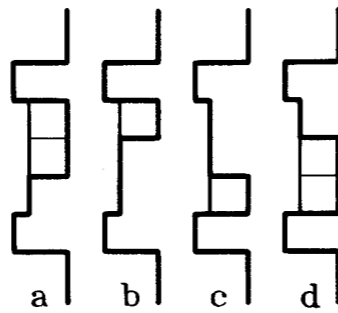

Fig. 4

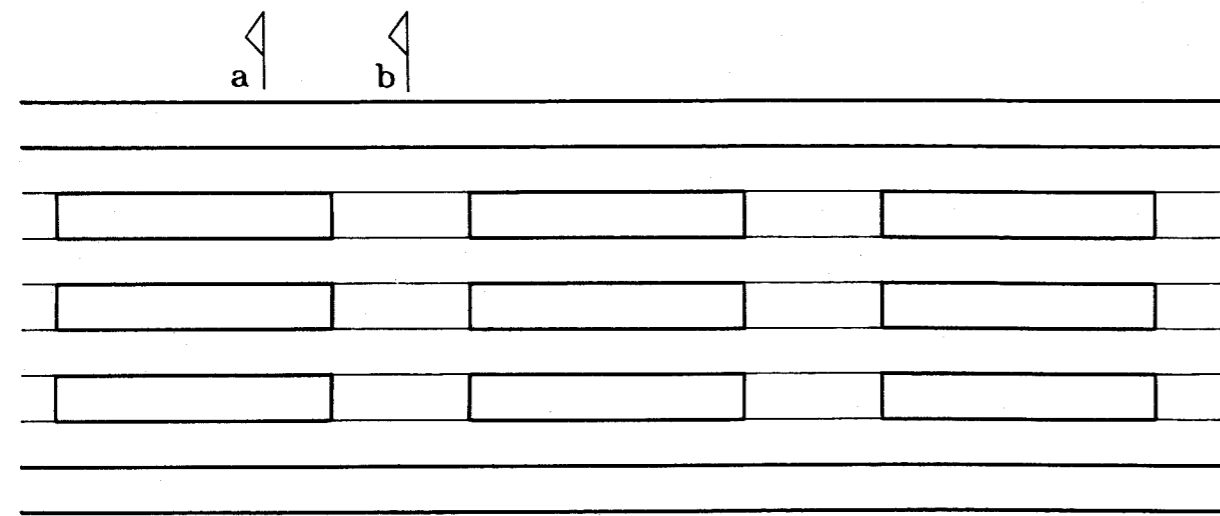
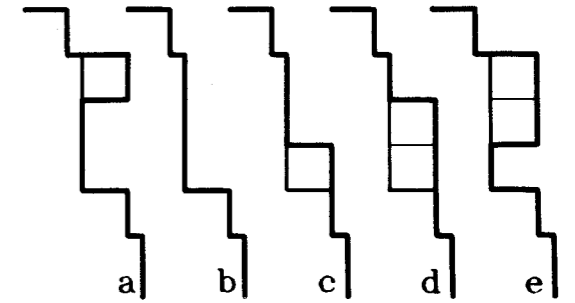

Fig. 5

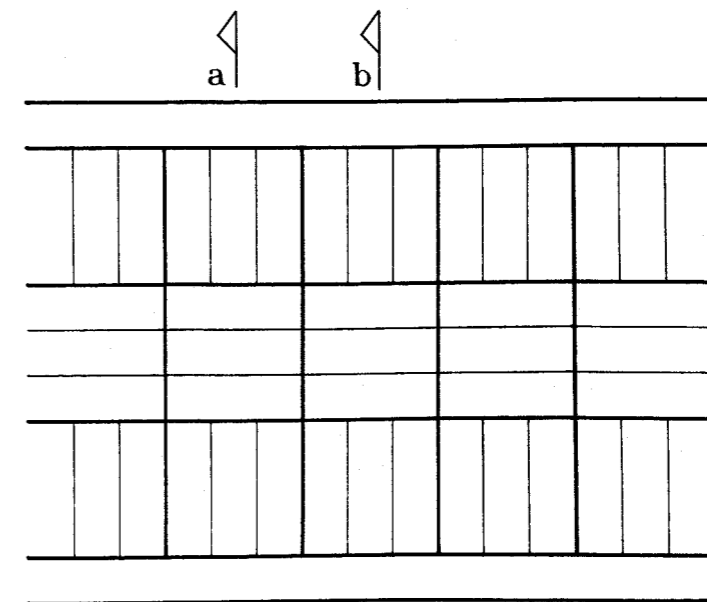
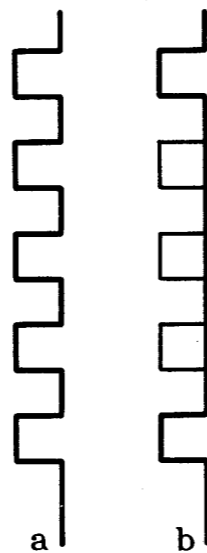
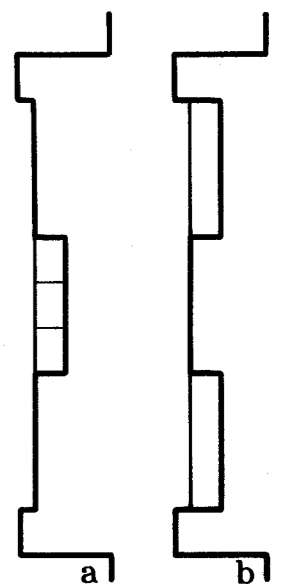

Fig. 6



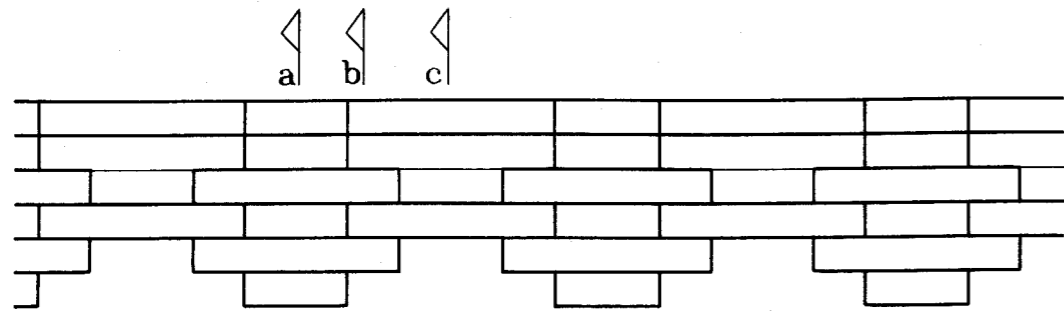

Fig. 1

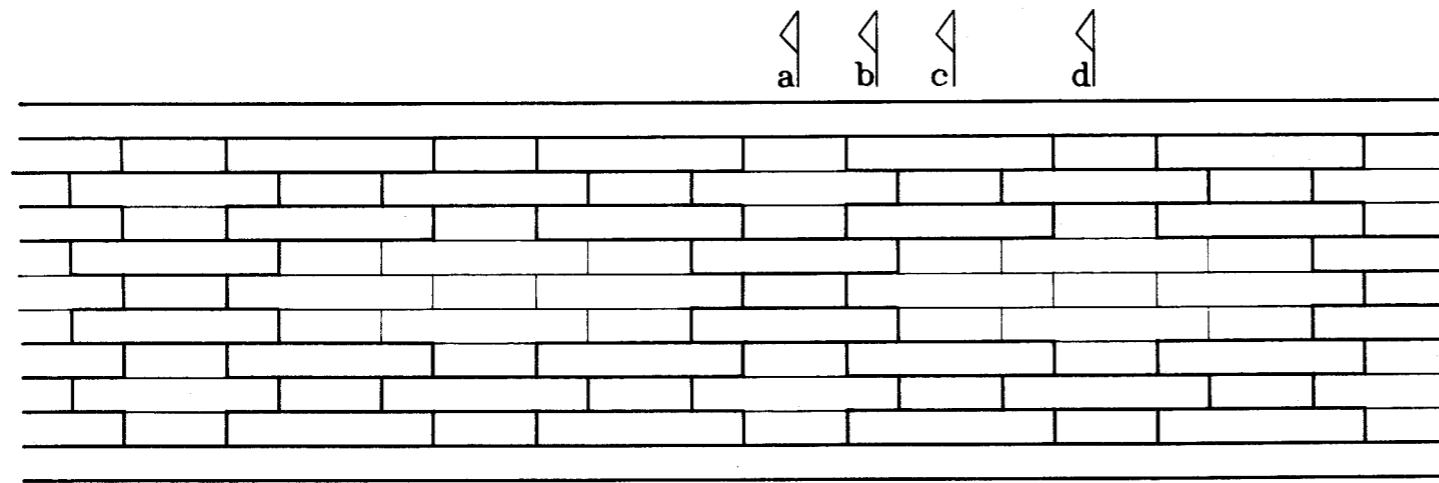
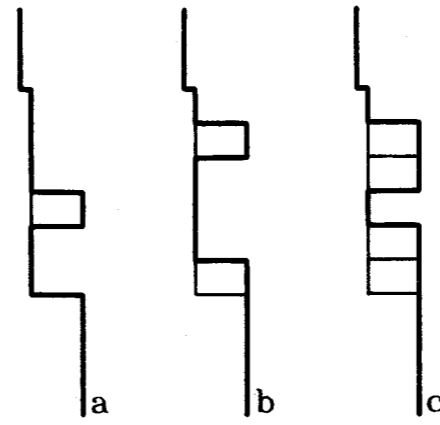

Fig. 2

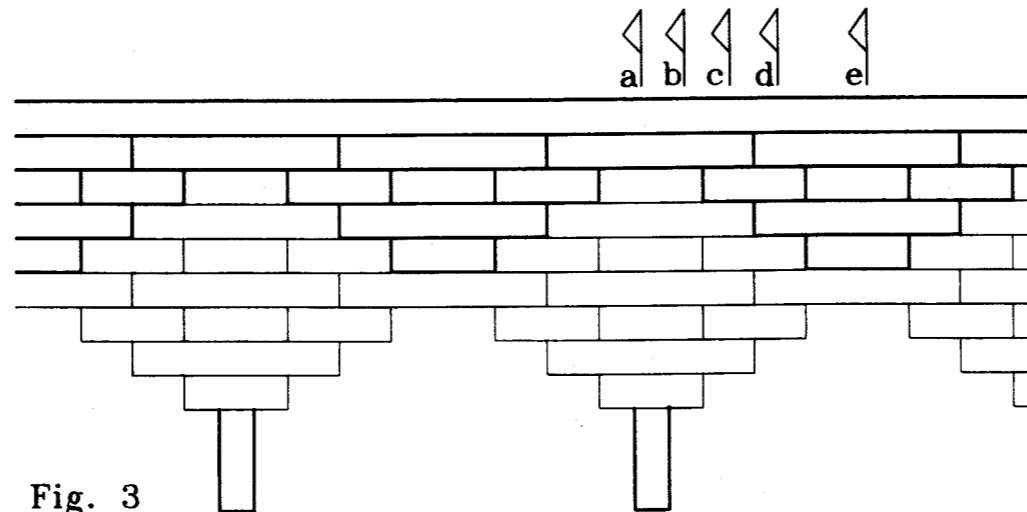
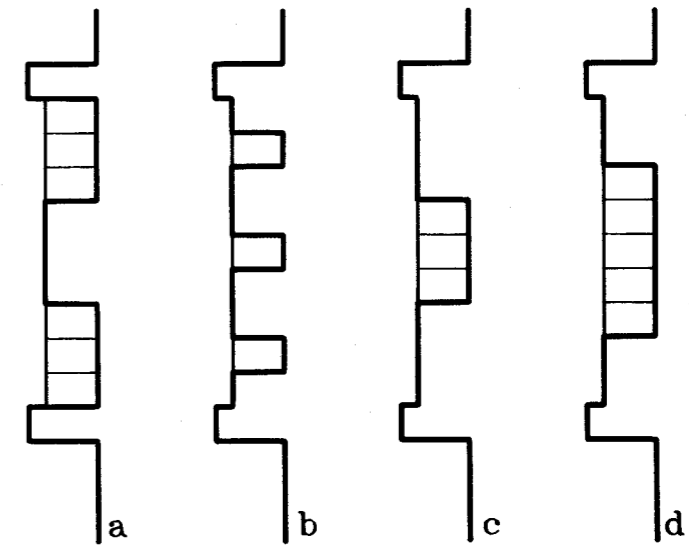
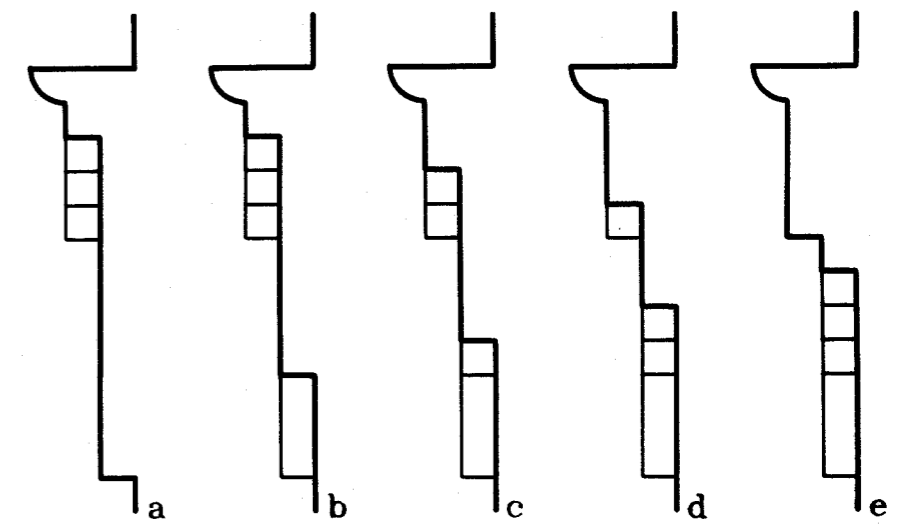

Fig. 3



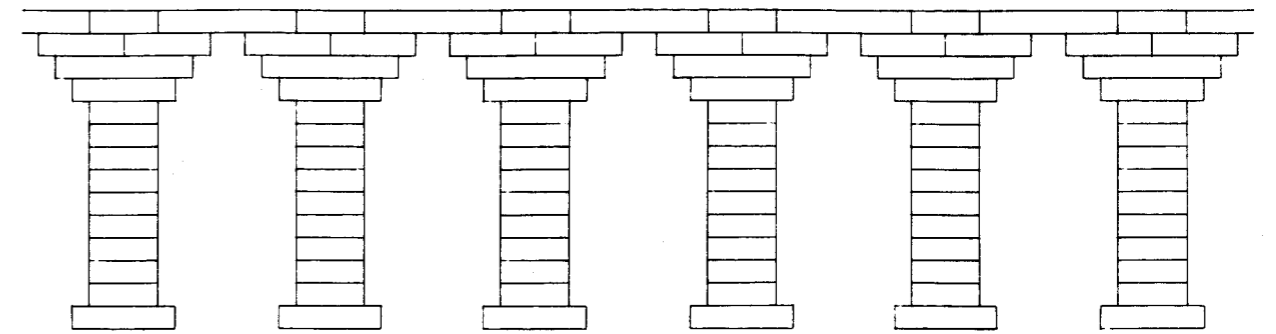
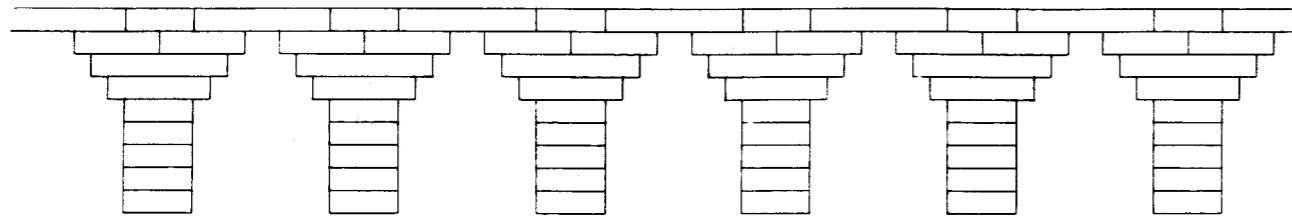

Fig. 5

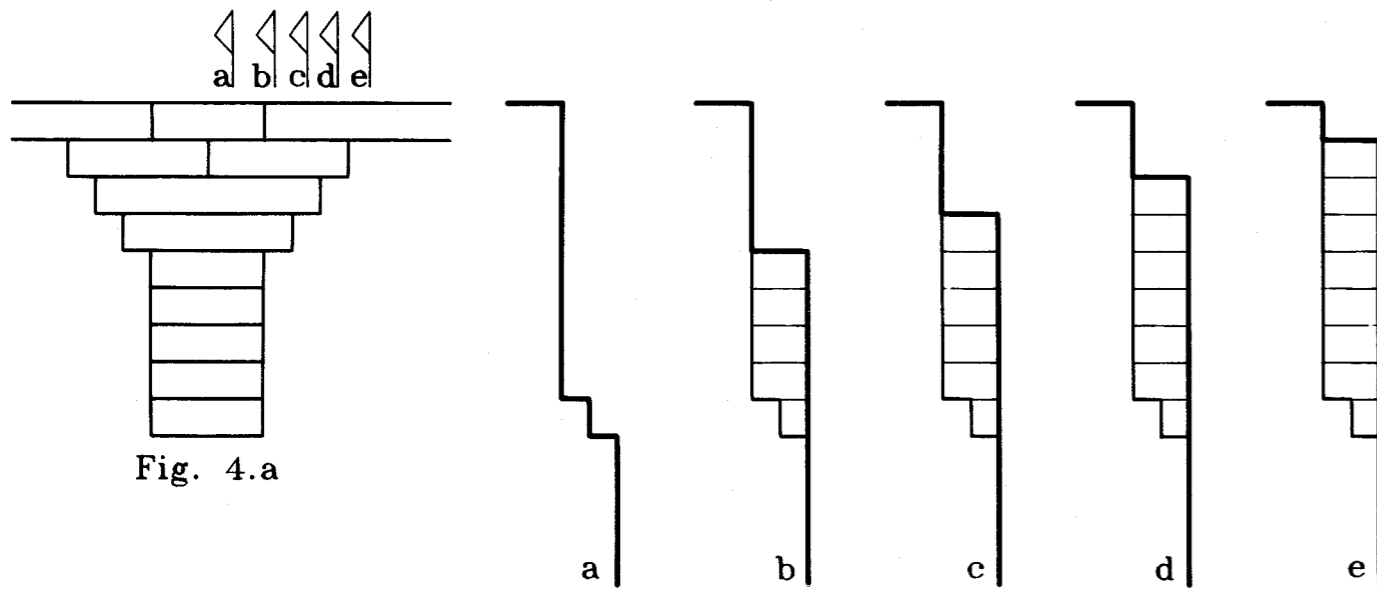

Fig. 4.a

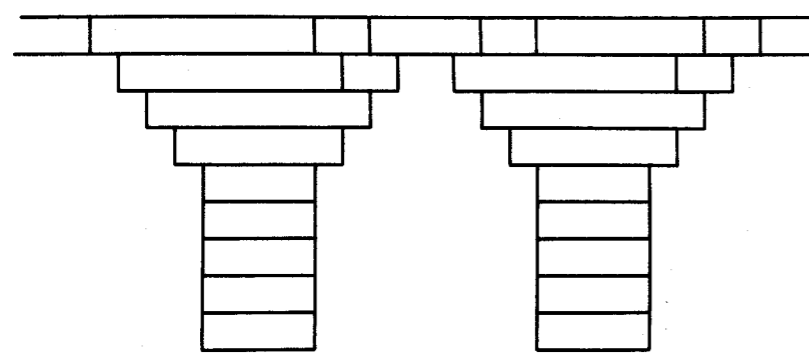
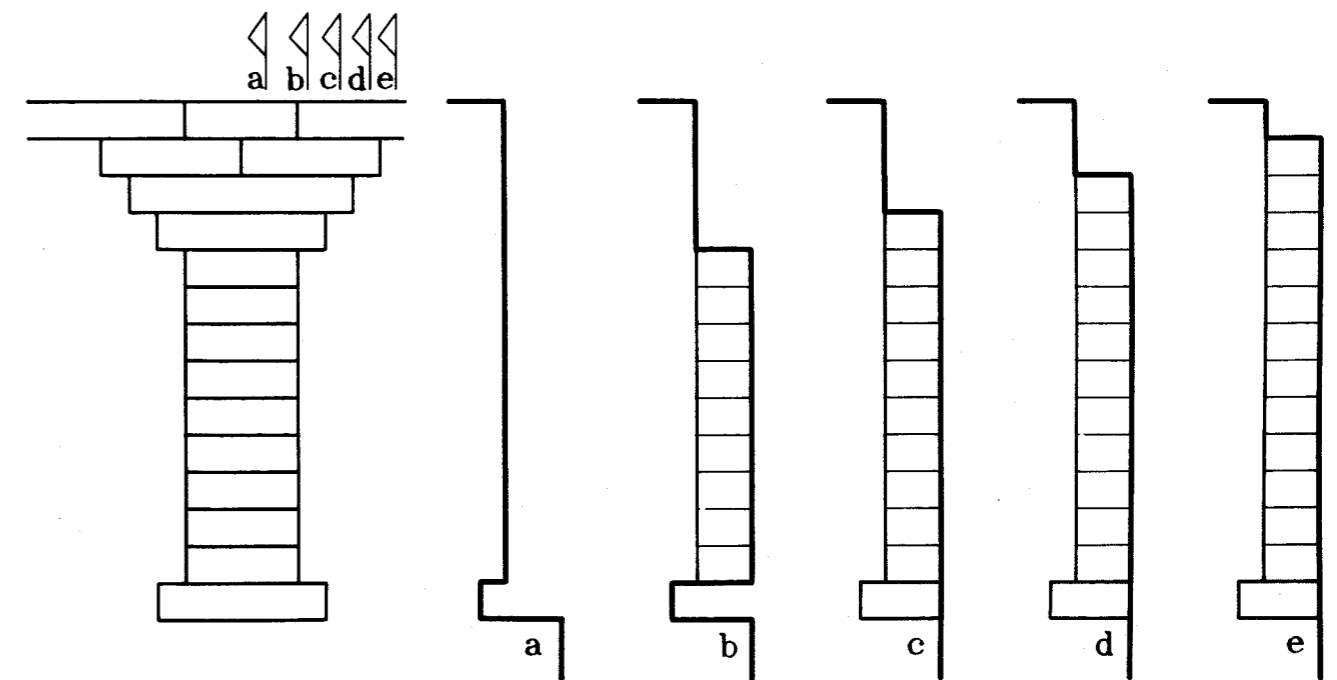

Fig. 4.b



a

b

c

d

e

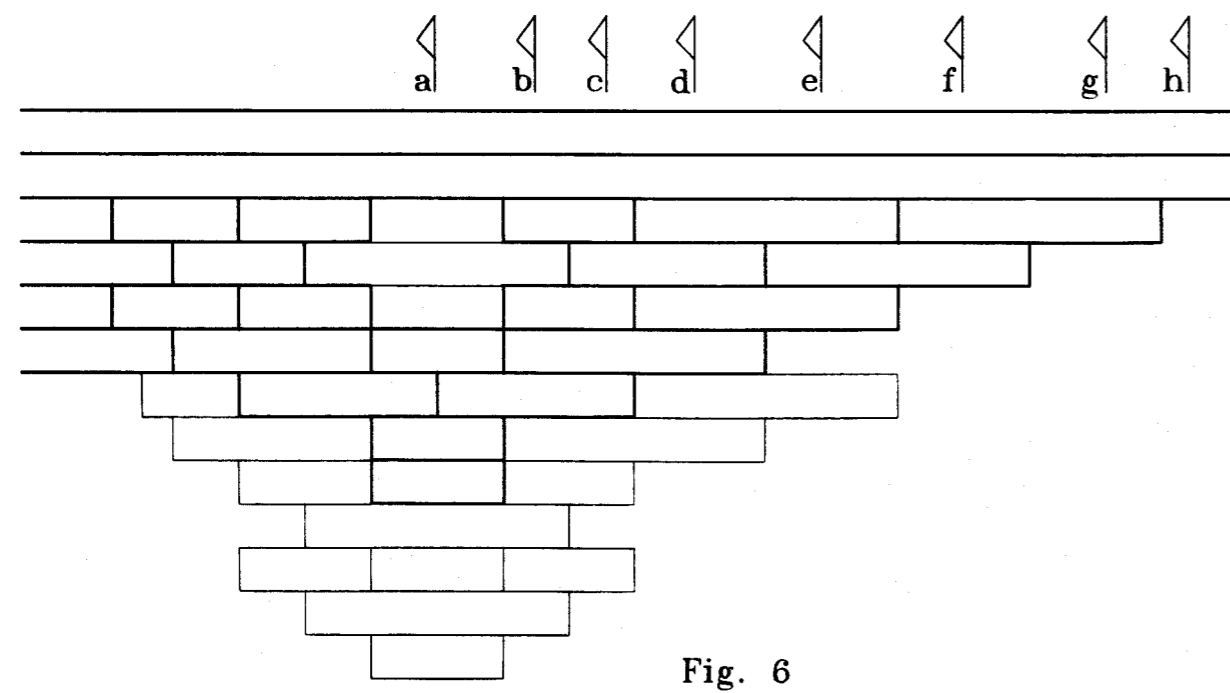
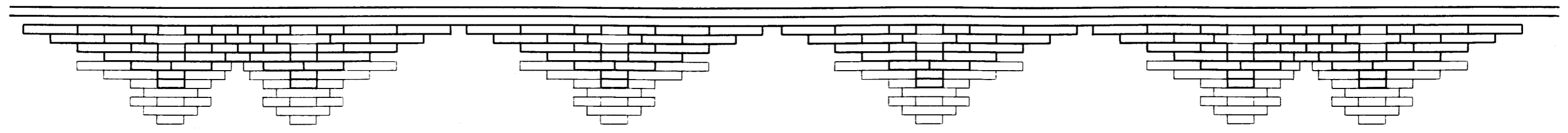
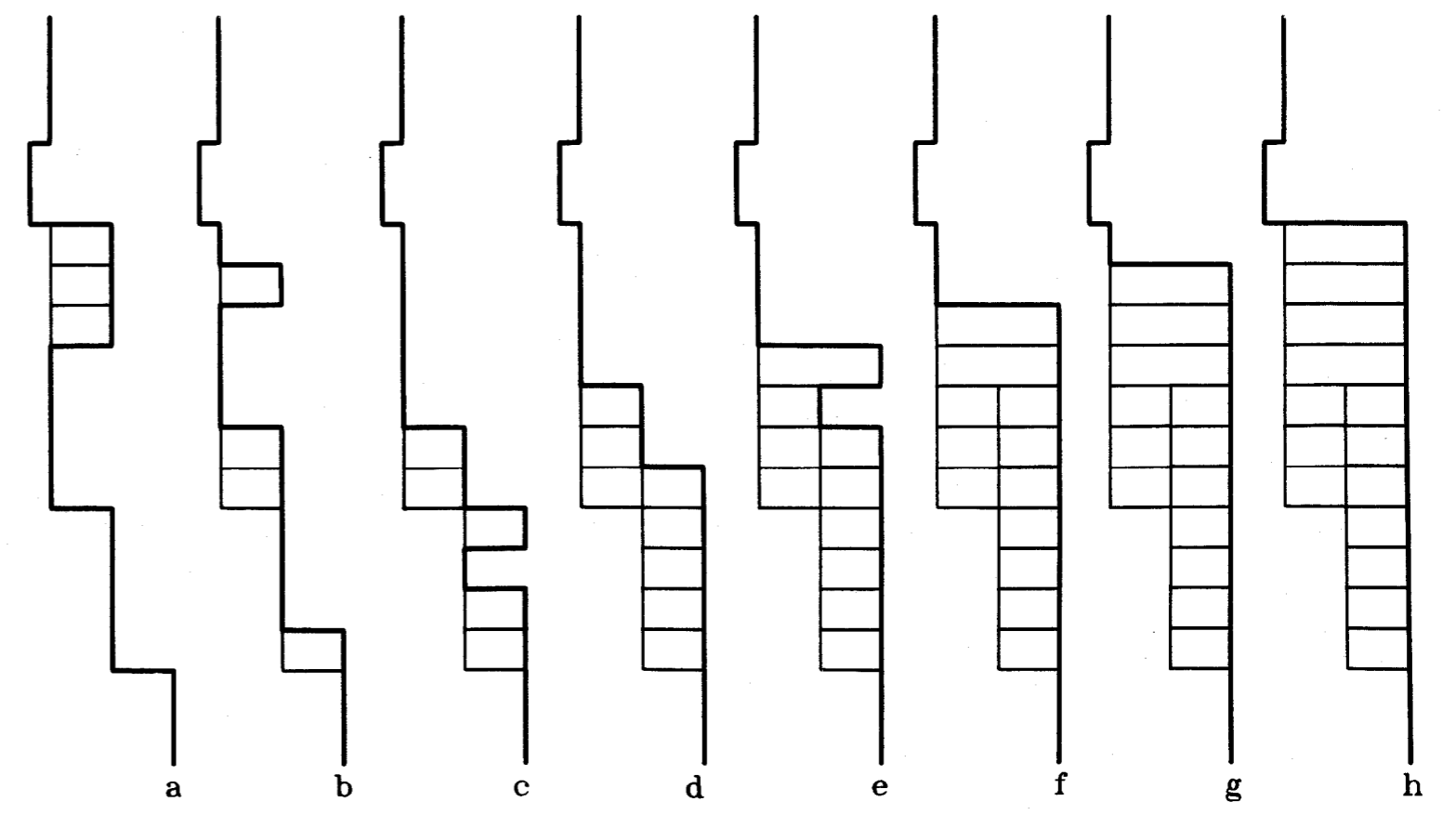

Fig. 6



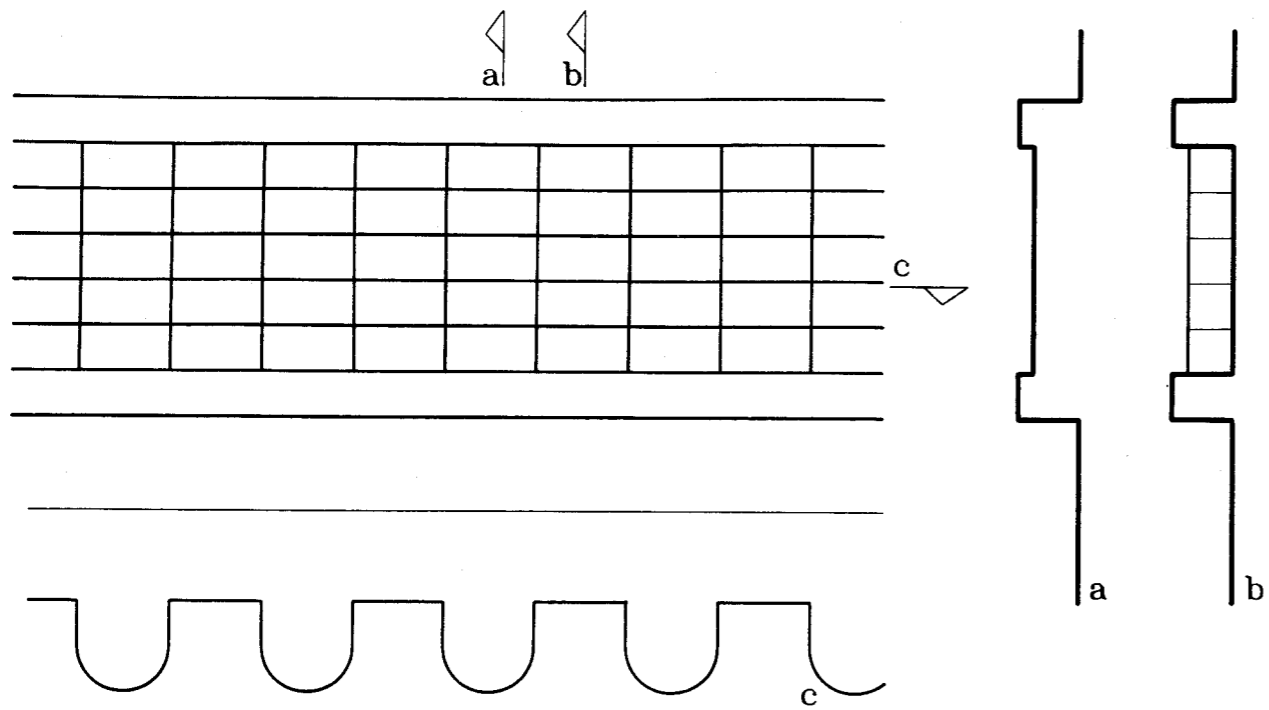

Fig. 1

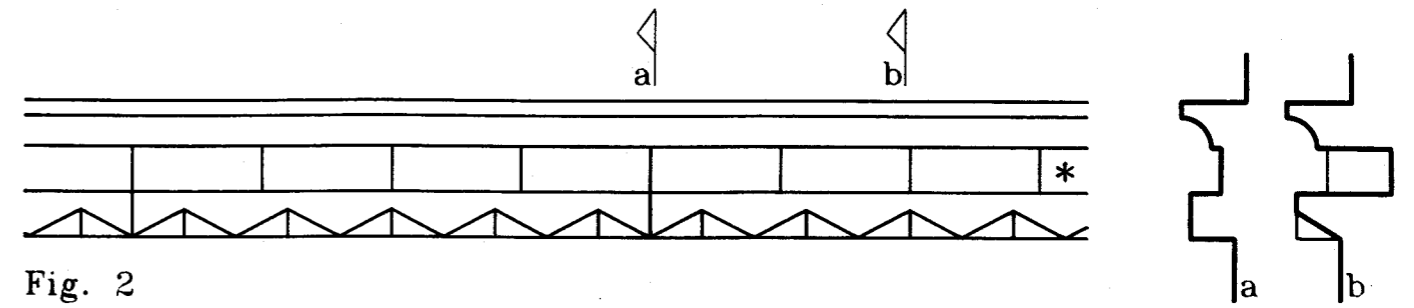

Fig. 2

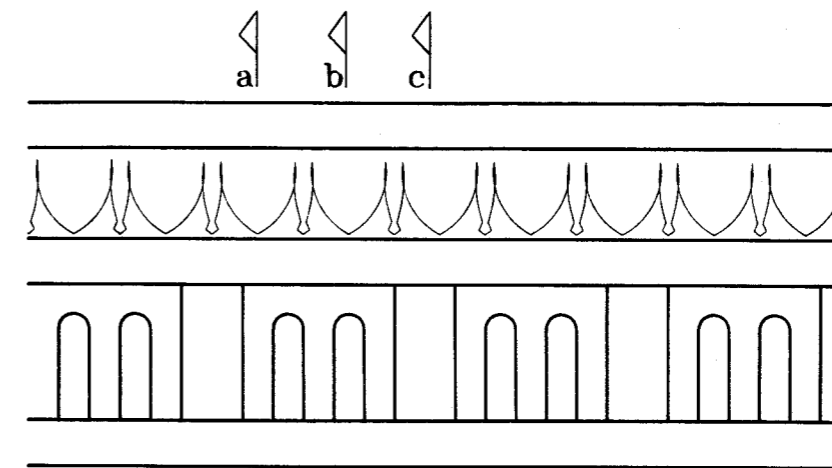

Fig. 4

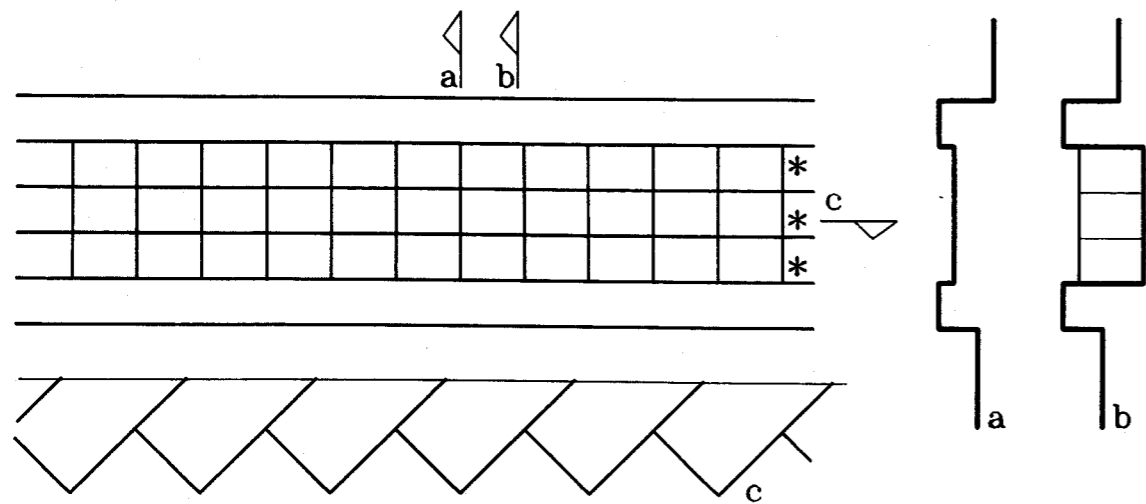
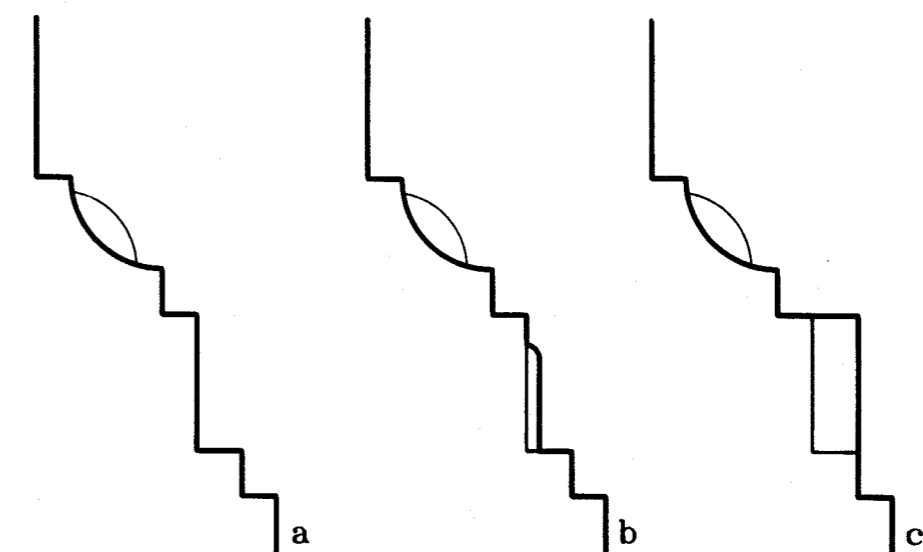
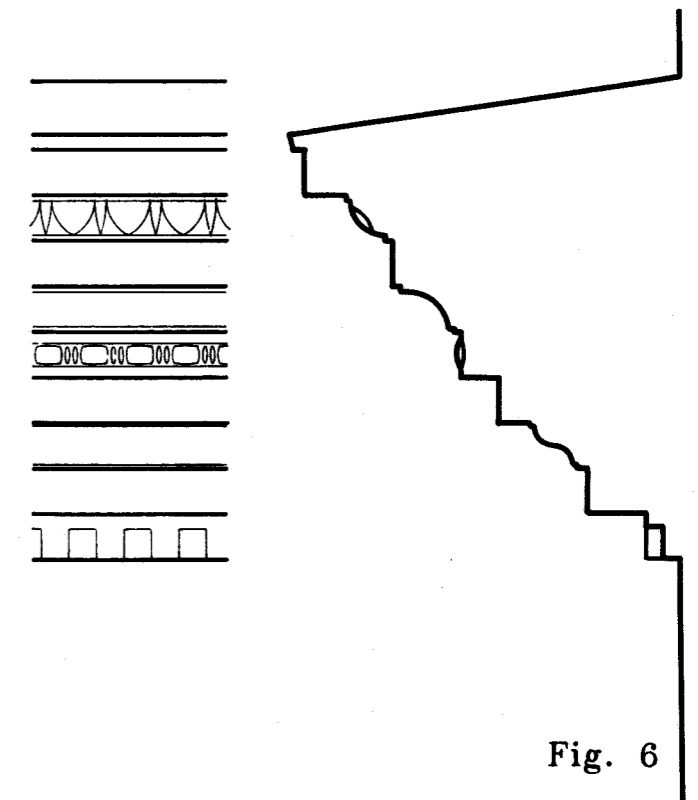
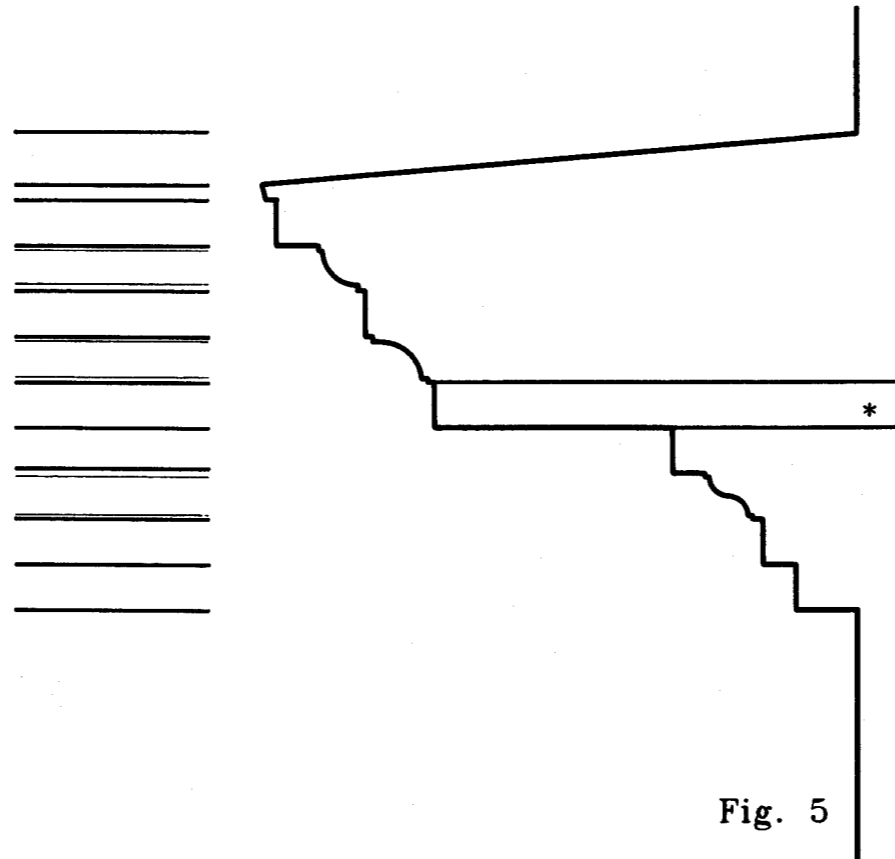
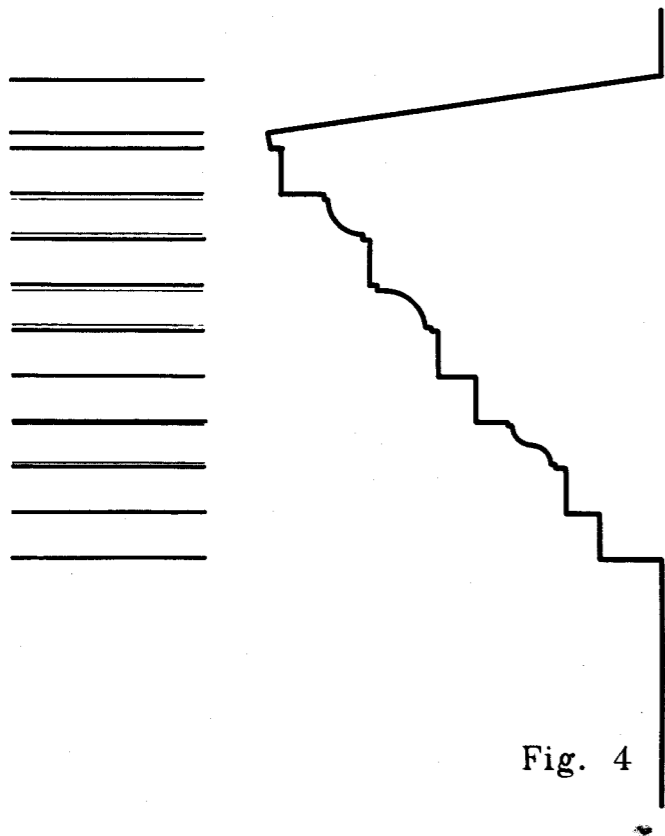
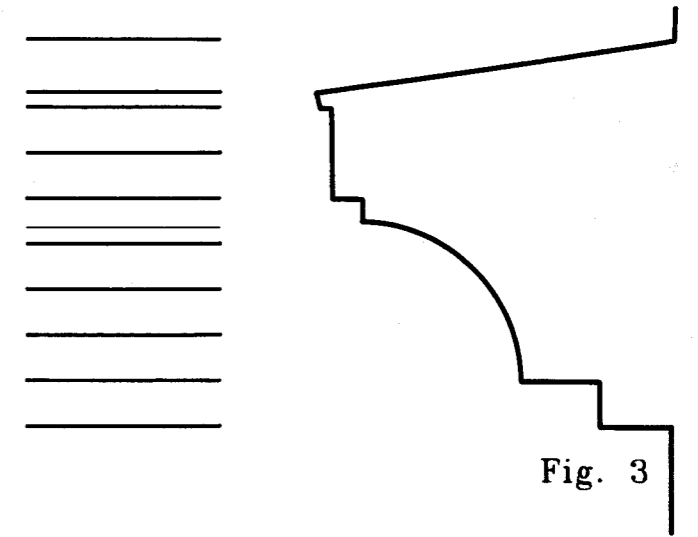
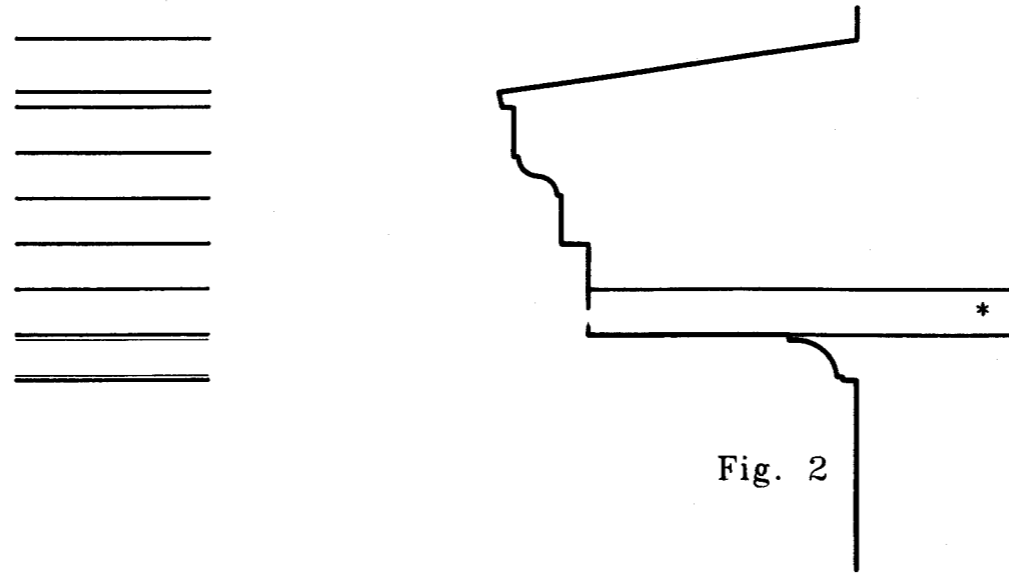
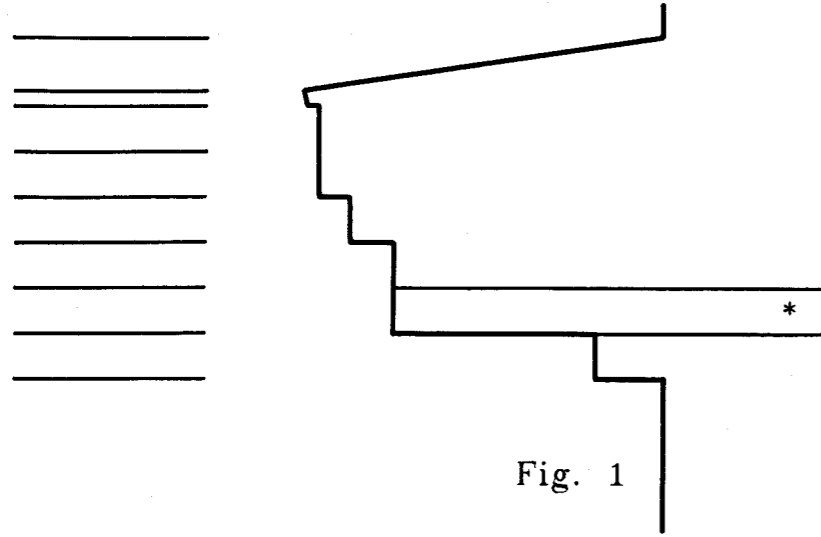

Fig. 3



LAMINA 0609
IMPOSTAS Y CORNISAS
TIPOS DE CUERPOS VOLADOS



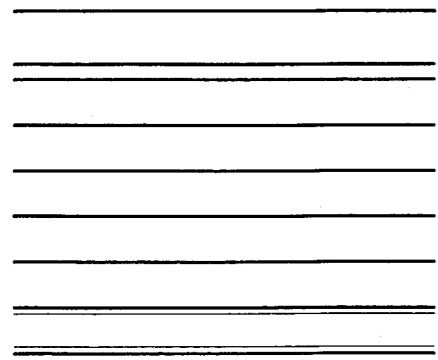

Fig. 1

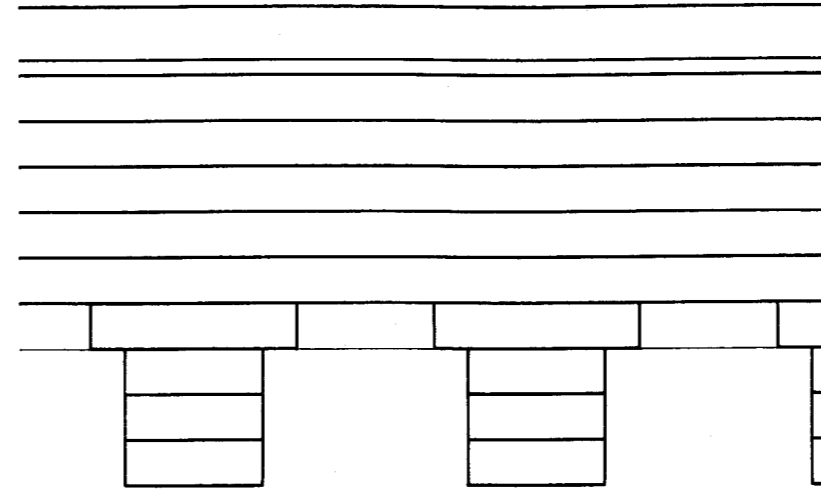
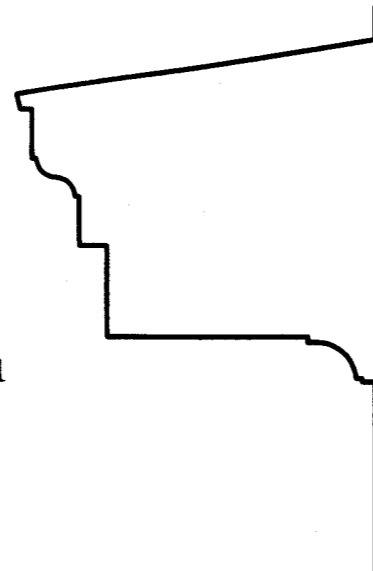

Fig. 3

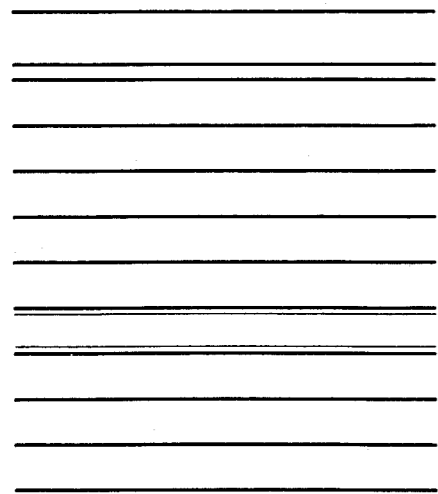
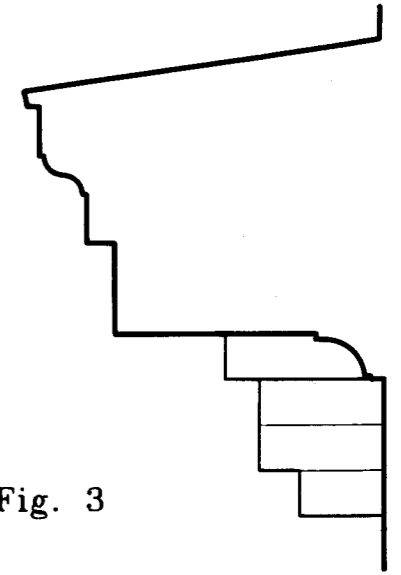

Fig. 2

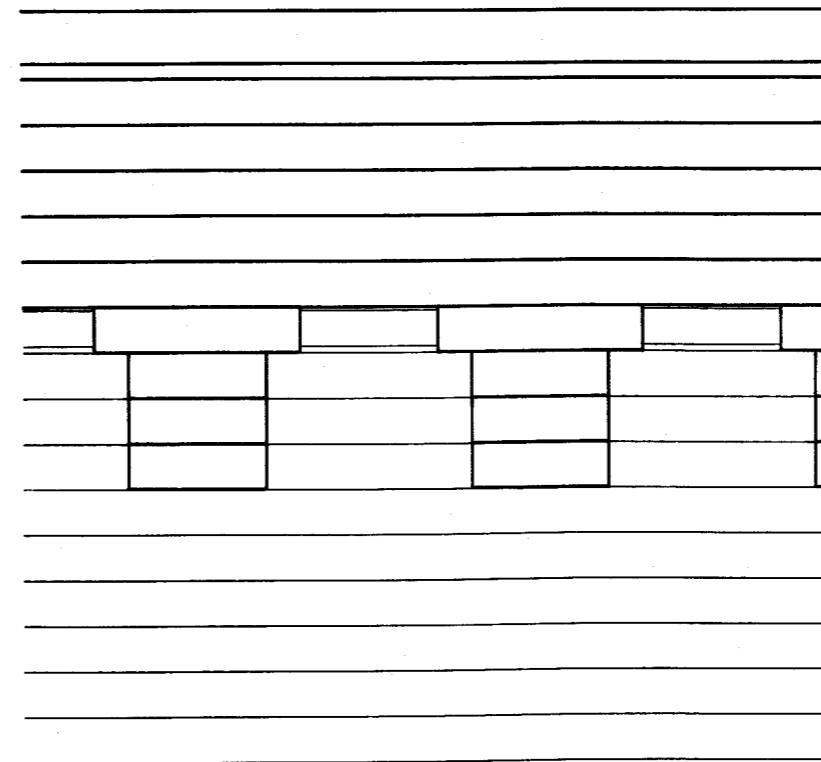
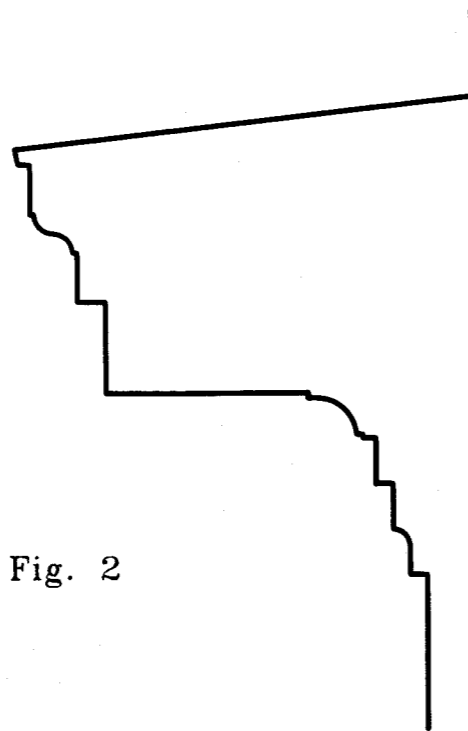
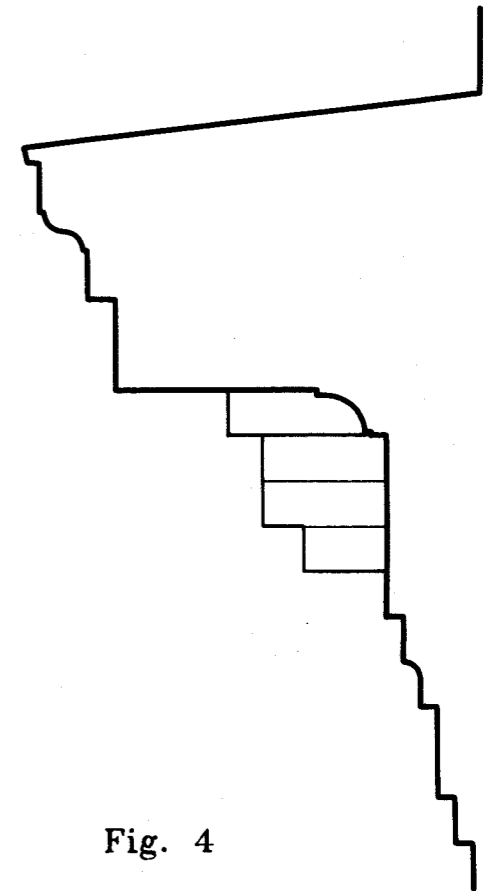

Fig. 4



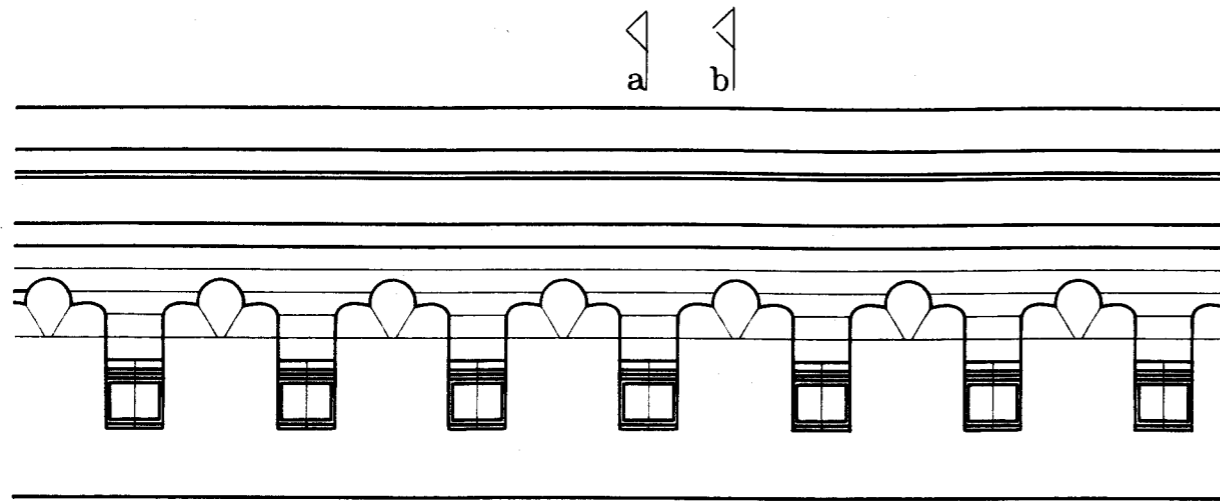

Fig. 1

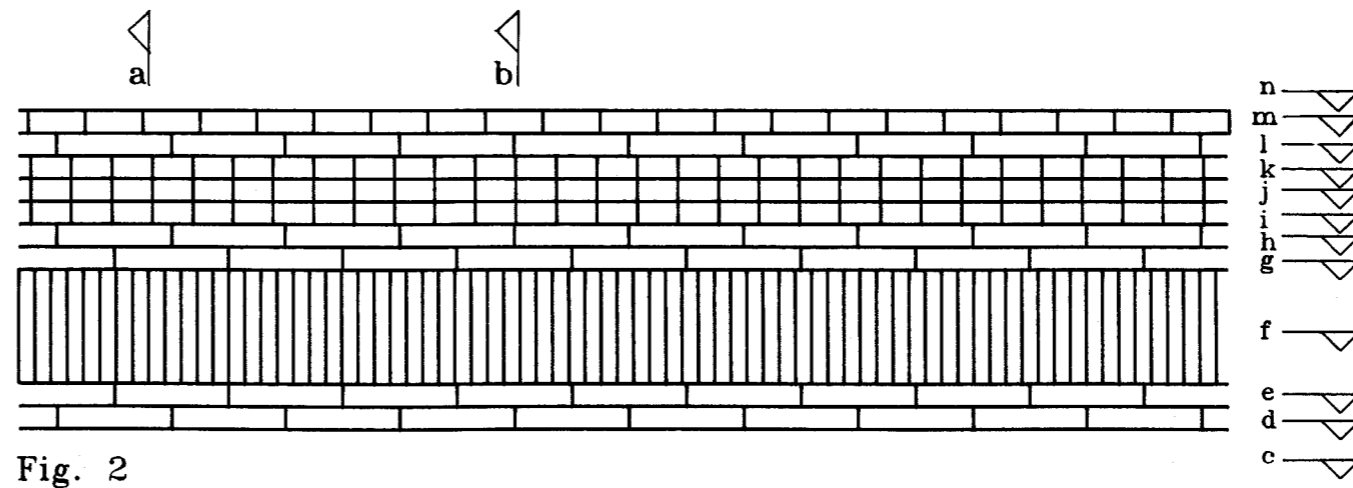
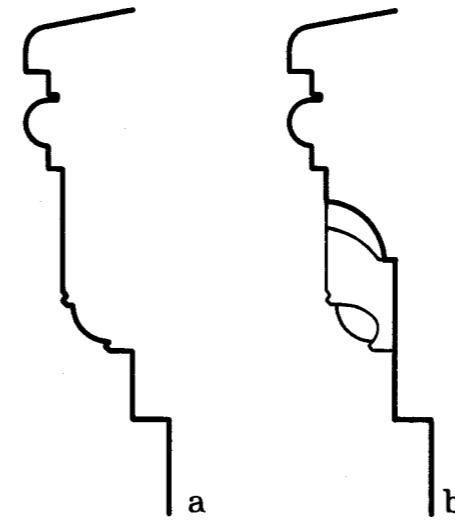
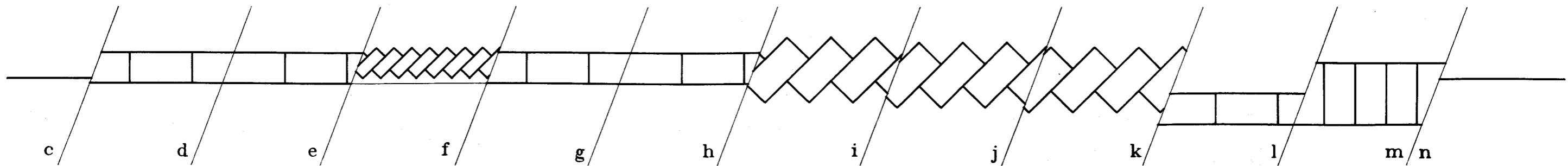
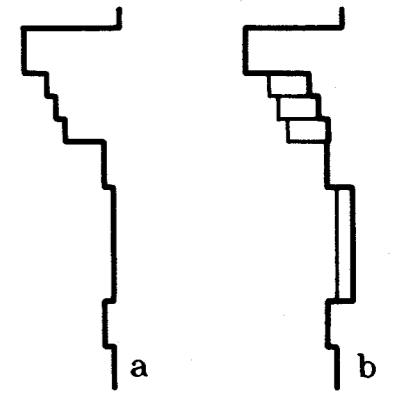

Fig. 2



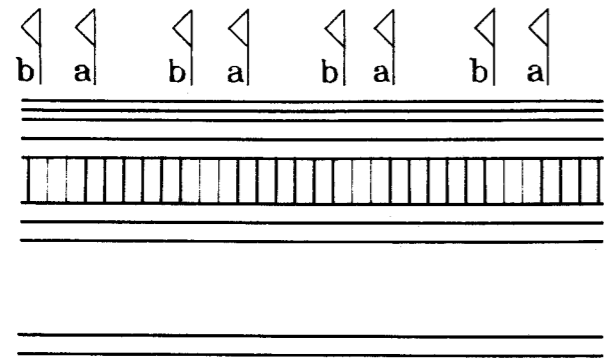

Fig. 3

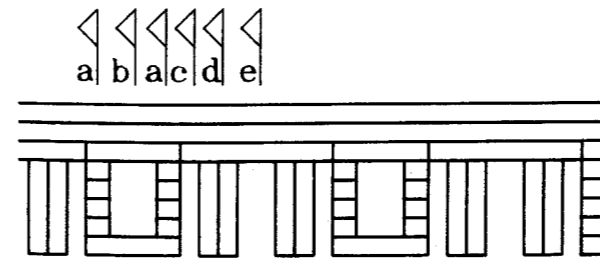
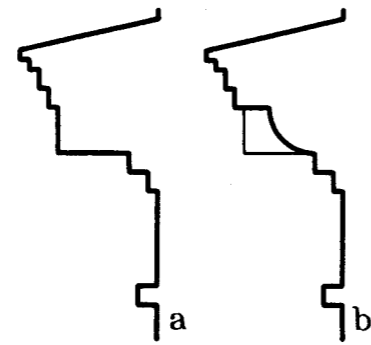

Fig. 4

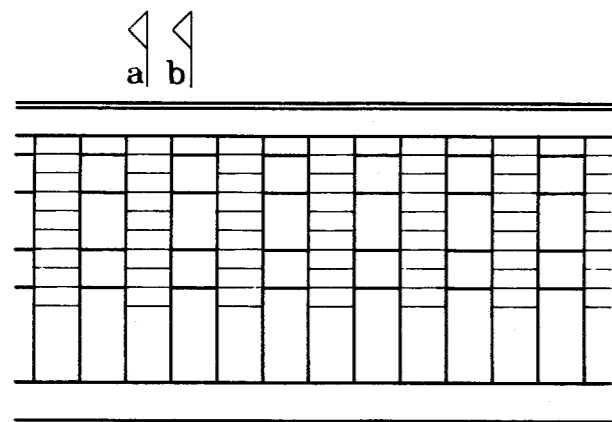
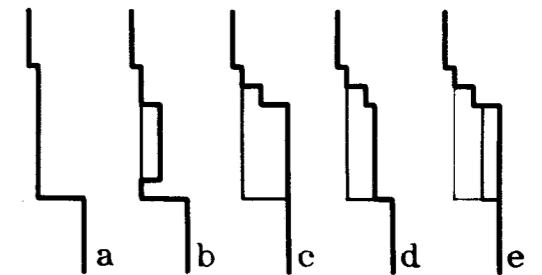

Fig. 5

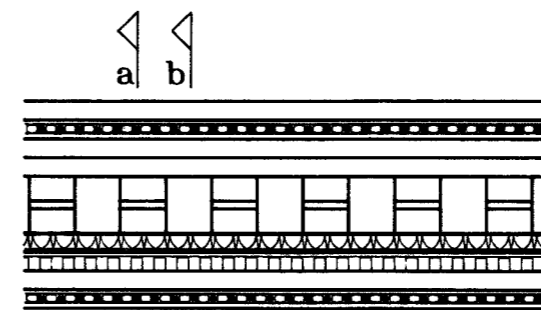
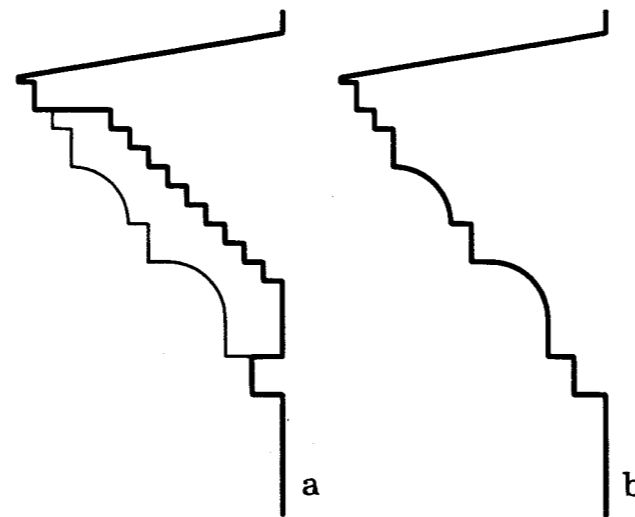

Fig. 6

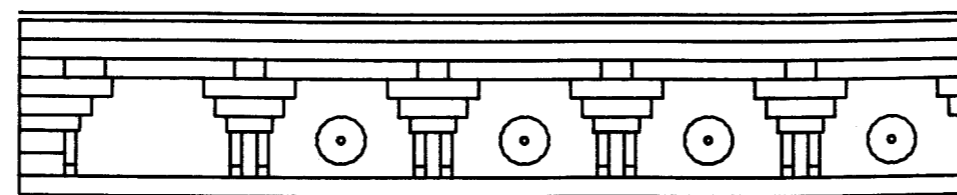
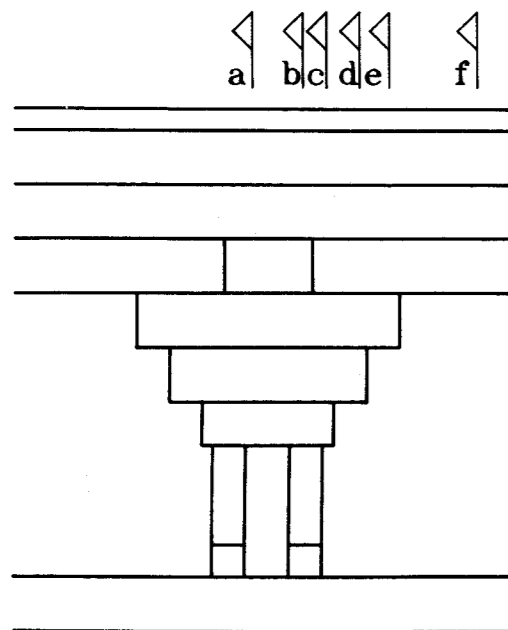
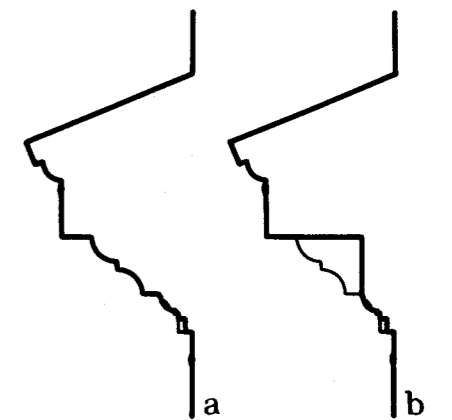
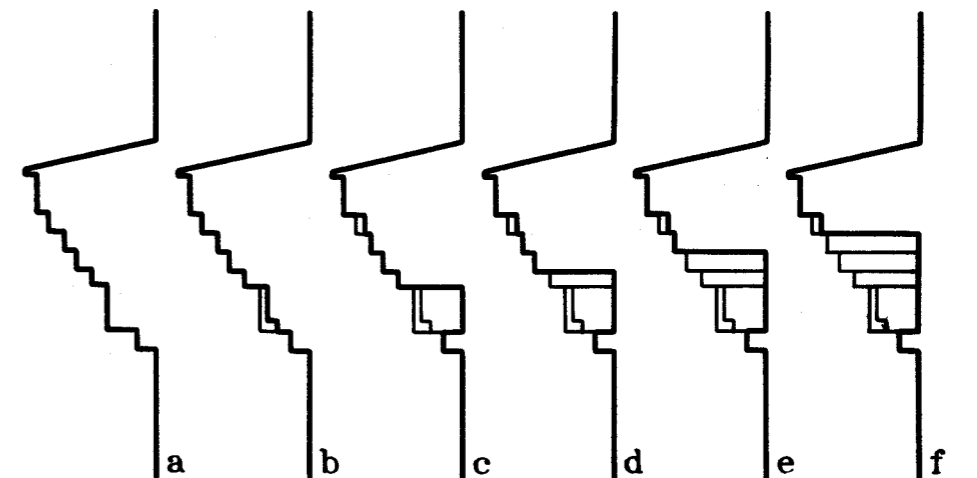
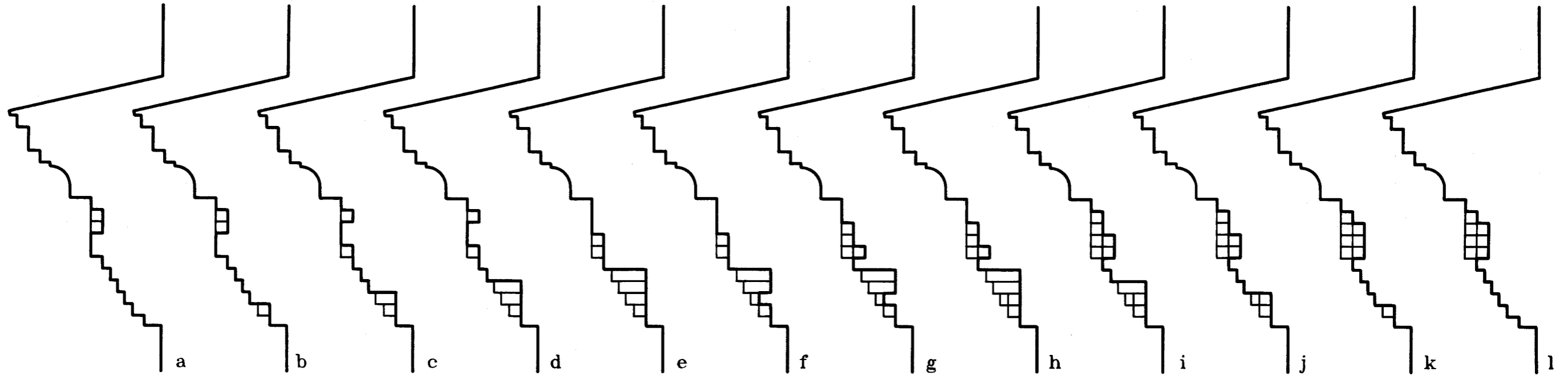

Fig. 7





↑↑↑↑↑↑↑↑↑↑↑↑↑↑↑↑
a b c d e f g h i j k l

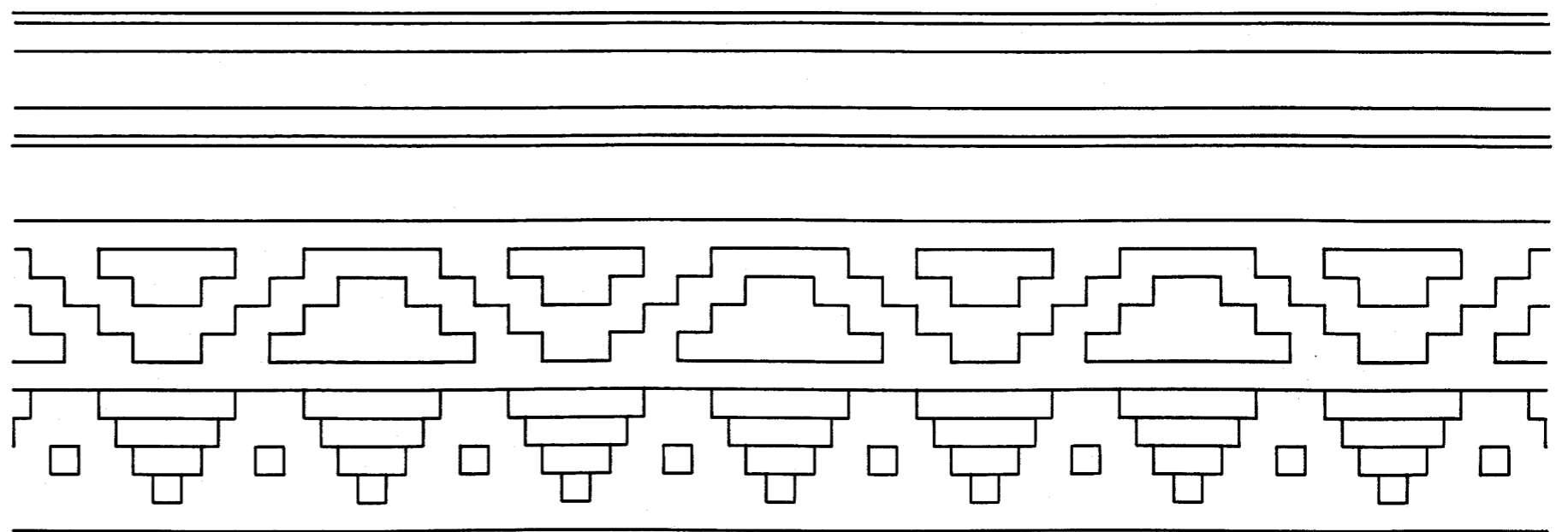
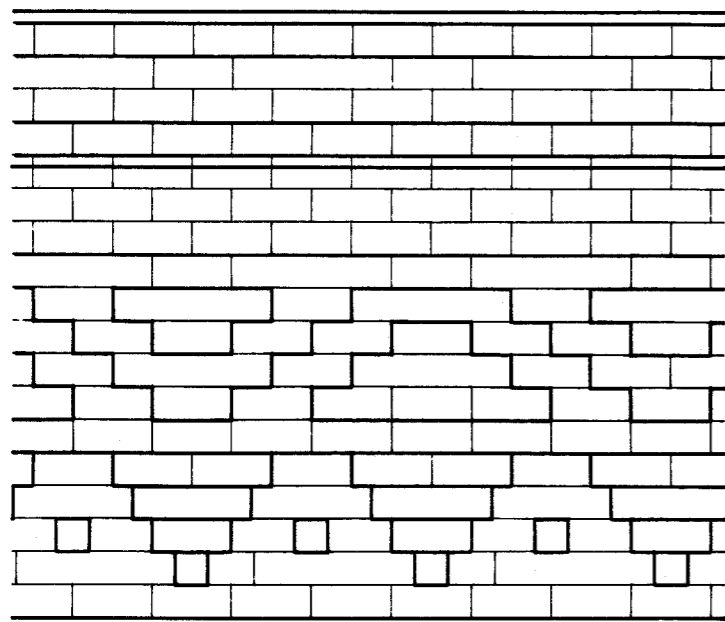

Fig. 8

ALMENADOS, CRESTERIAS, ANTEPECHOS Y BALCONES ALMENADOS

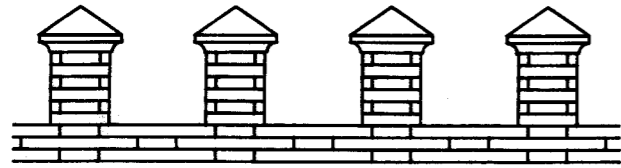

Fig. 1

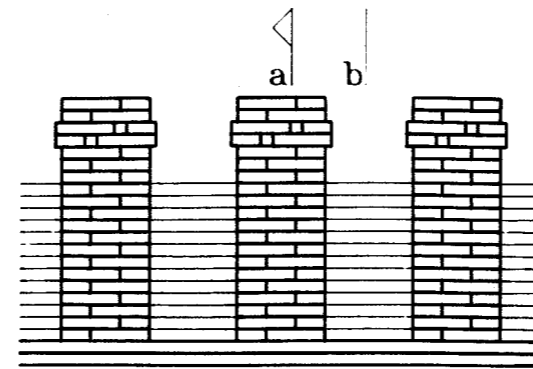

Fig. 3

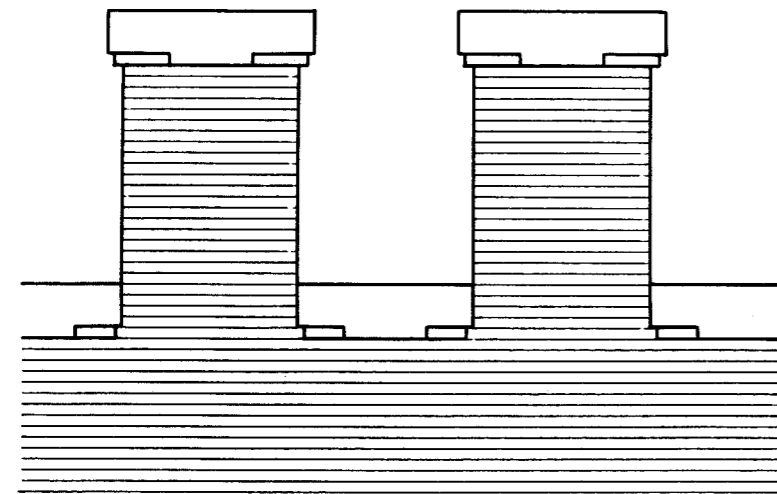

Fig. 2

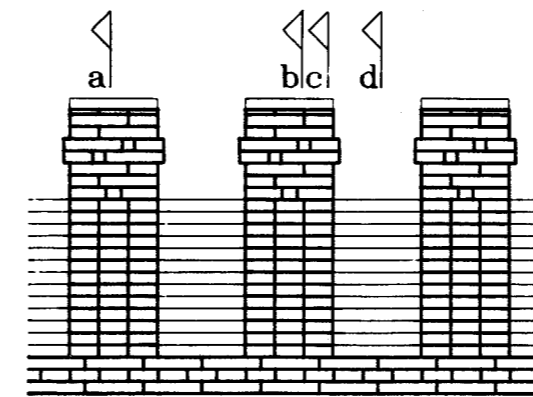

Fig. 4

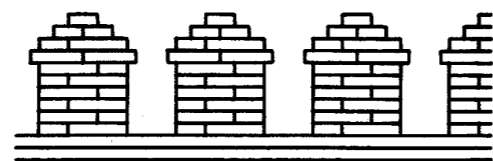

Fig. 5

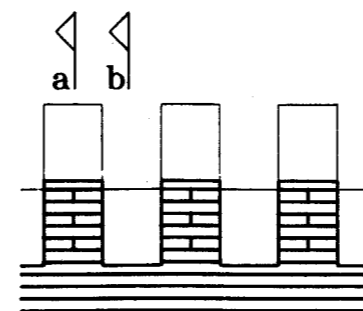

Fig. 6

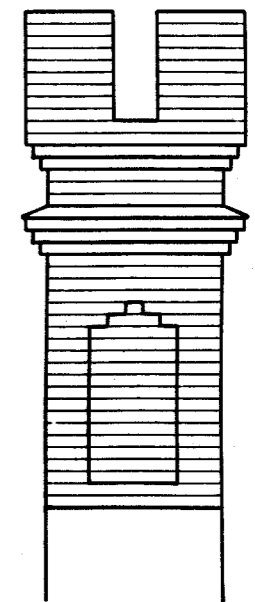

Fig. 7

LAMINA 0702
**ALMENADOS, CRESTERIAS, ANTEPECHOS Y BALCONES
 CRESTERIAS**

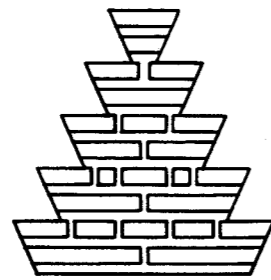

Fig. 2

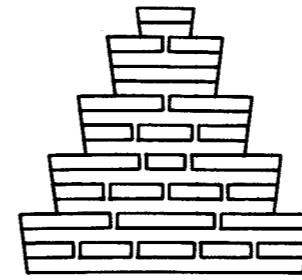

Fig. 3

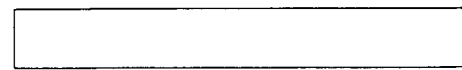

Fig. 1.a

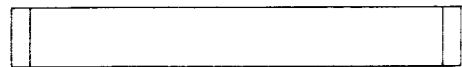

Fig. 1.b

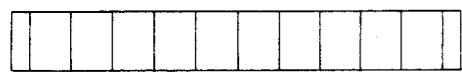

Fig. 1.c



Fig. 1.d



Fig. 1.e



Fig. 1.f



Fig. 1.g

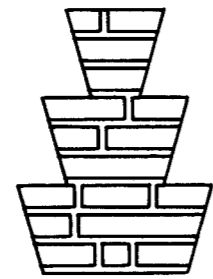

Fig. 4

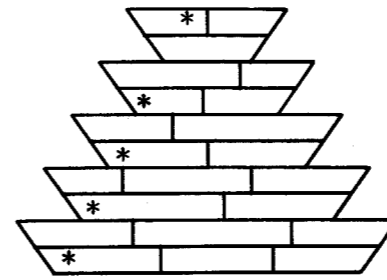

Fig. 5 * Hiladas de color rojo

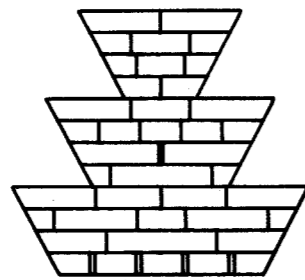

Fig. 6

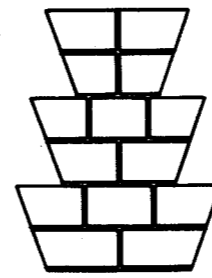
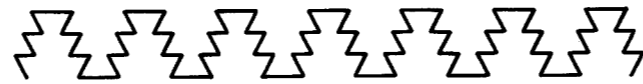

Fig. 7

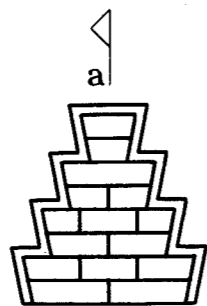

Fig. 8

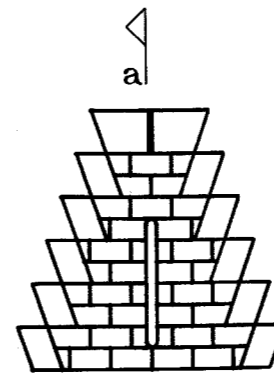

Fig. 9



ALMENADOS, CRESTERIAS, ANTEPECHOS Y BALCONES
EVOLUCION DEL ANTEPECHO

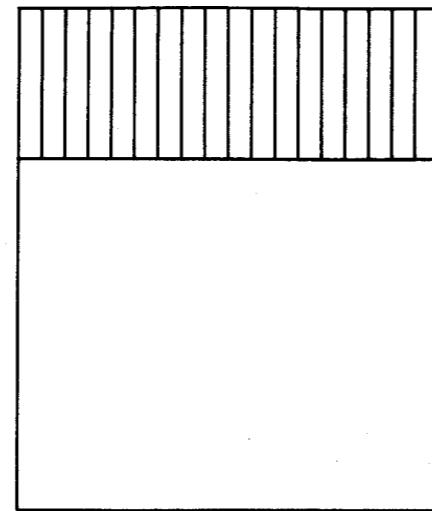
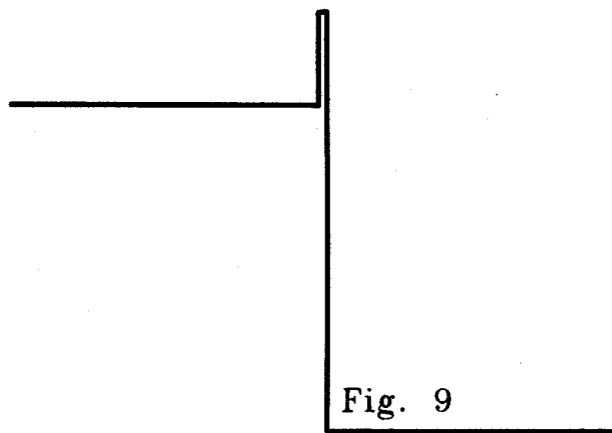
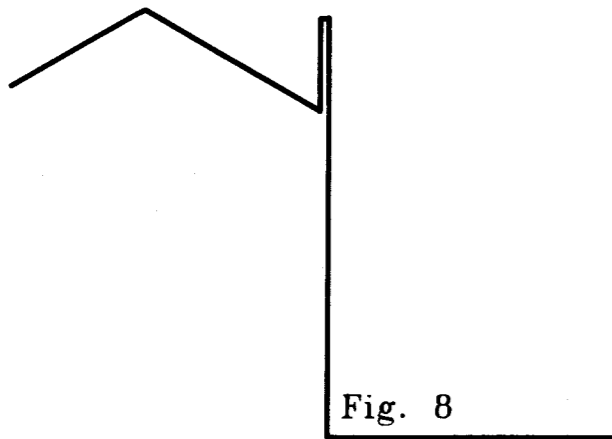
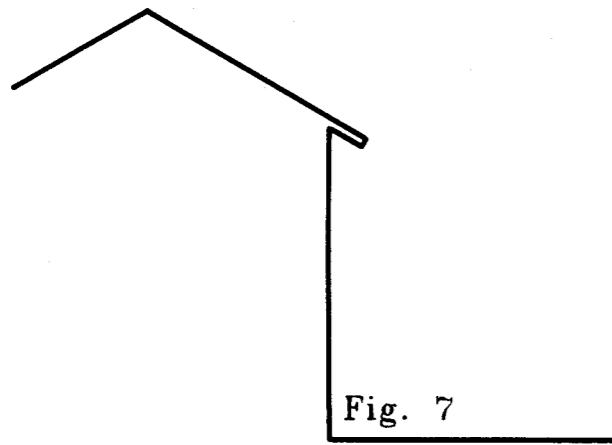

Fig. 1

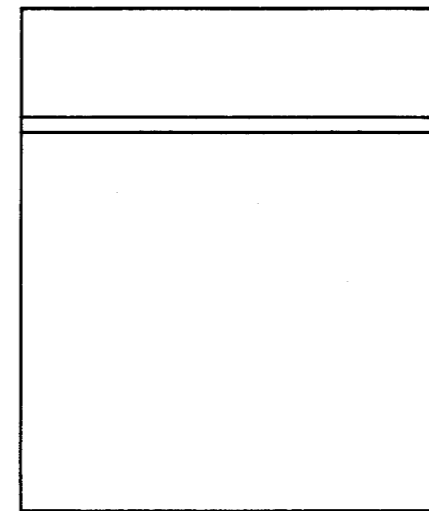

Fig. 2

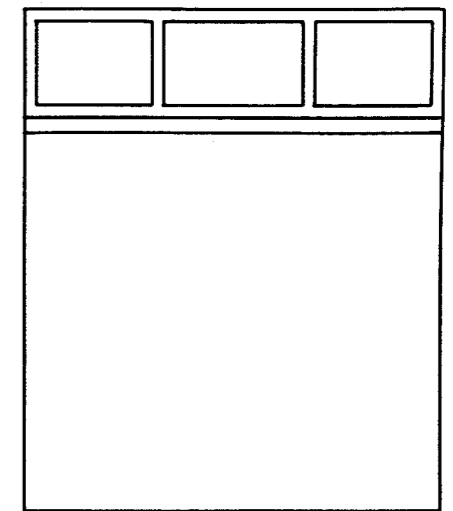

Fig. 3

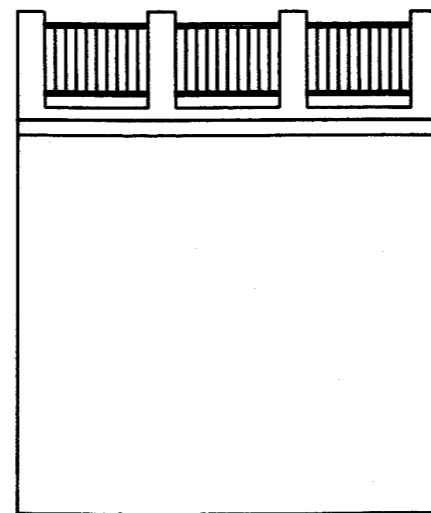

Fig. 4

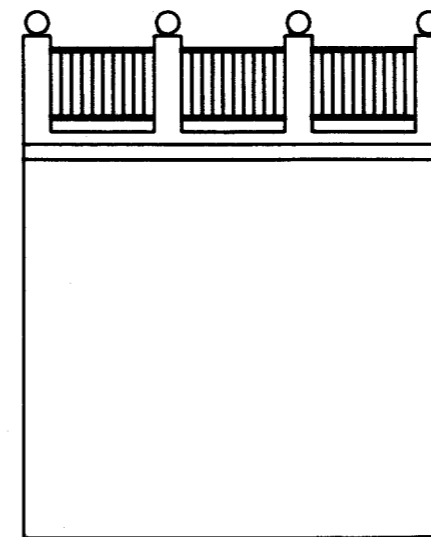

Fig. 5

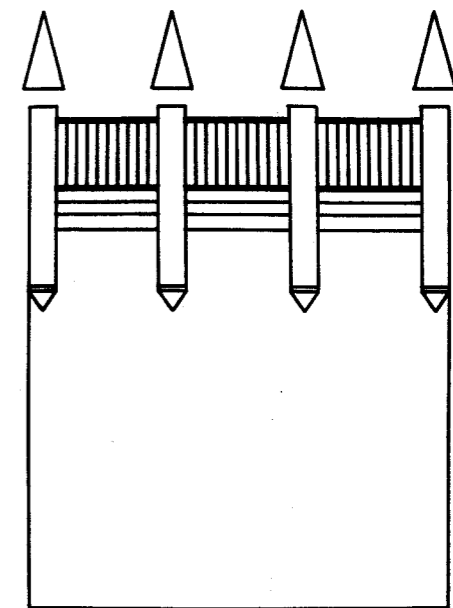

Fig. 6

ALMENADOS, CRESTERIAS, ANTEPECHOS Y BALCONES
ANTEPECHOS SINGULARES 1

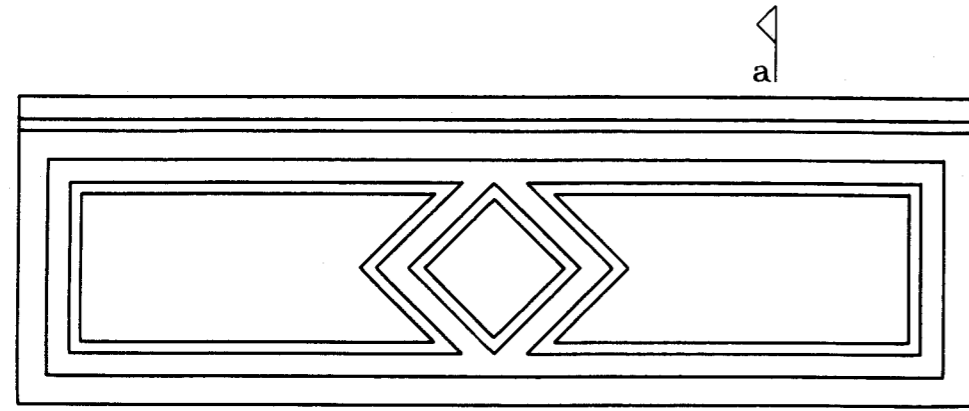

Fig. 1

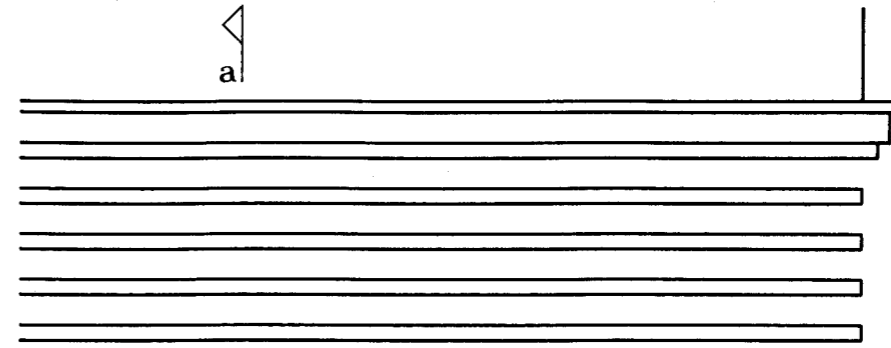

Fig. 3

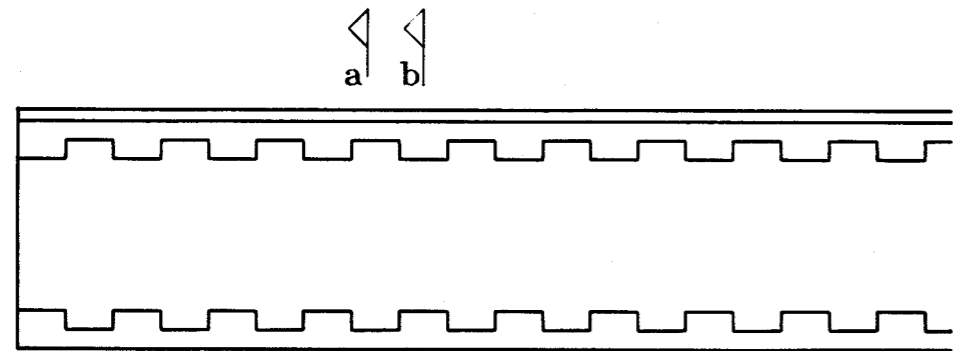
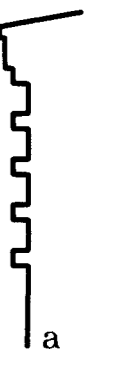

Fig. 2

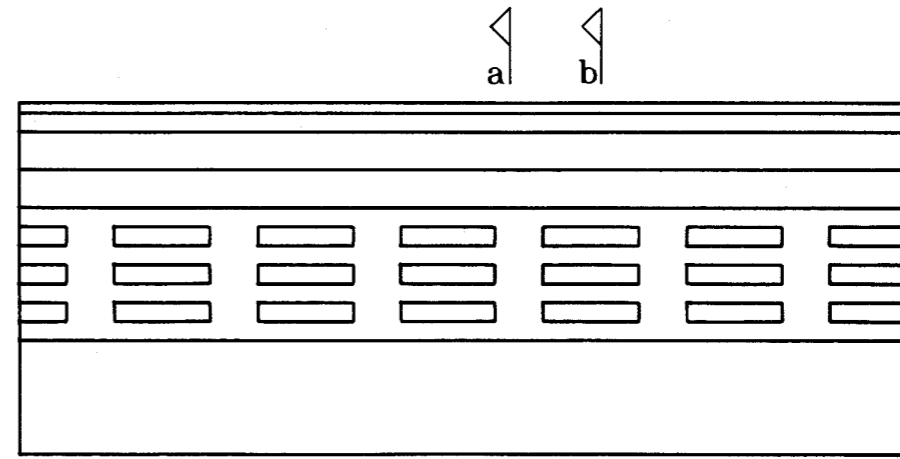
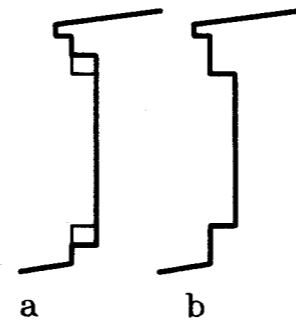

Fig. 4

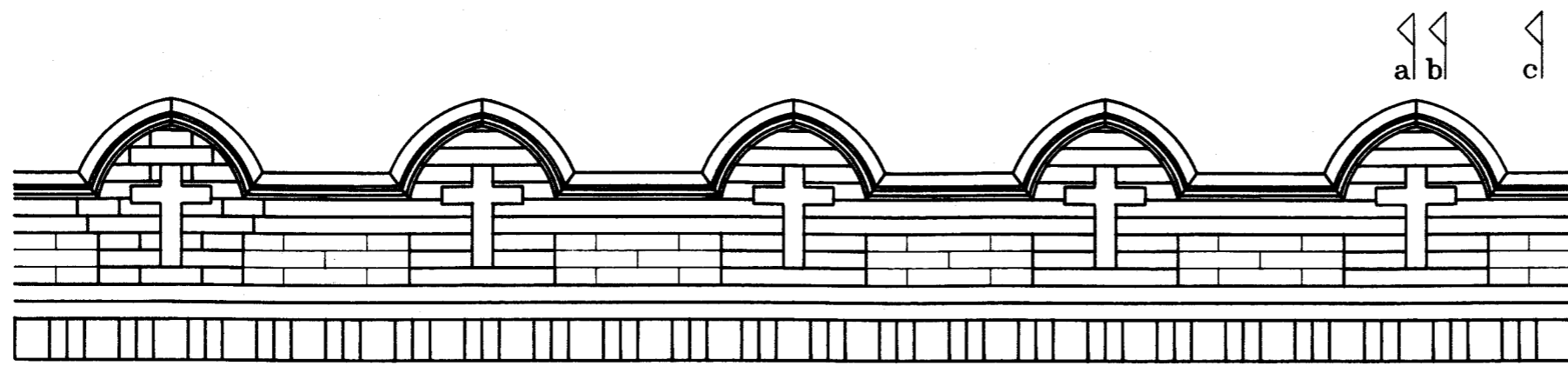
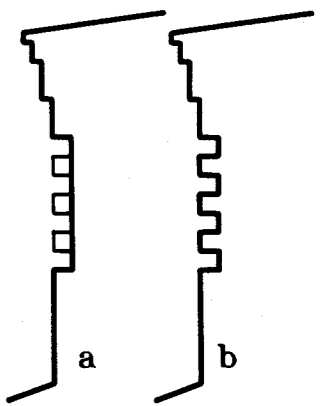
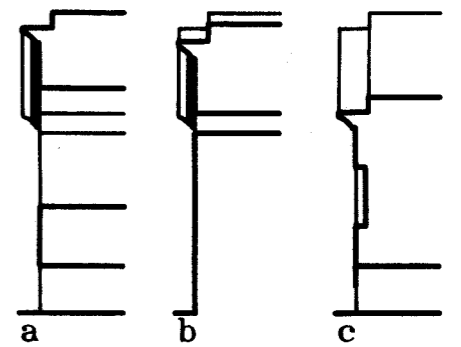

Fig. 5



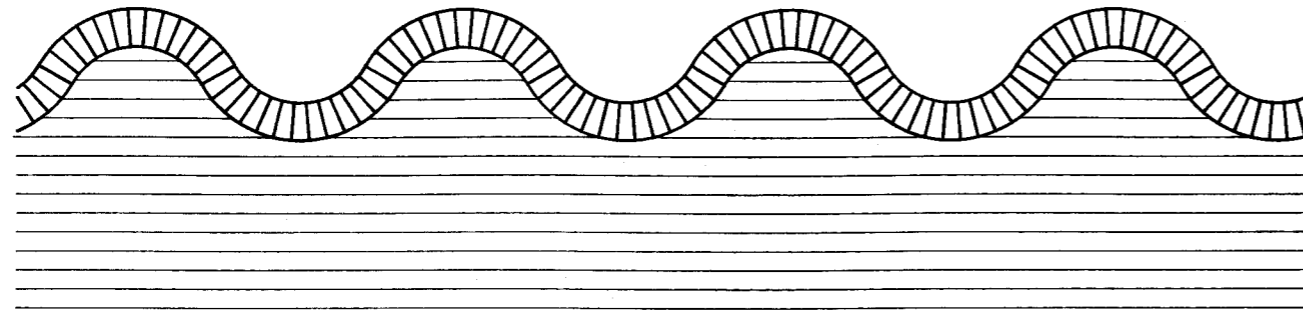

Fig. 6

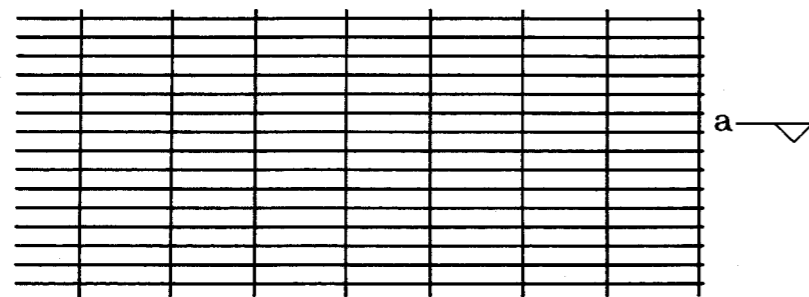

Fig. 7

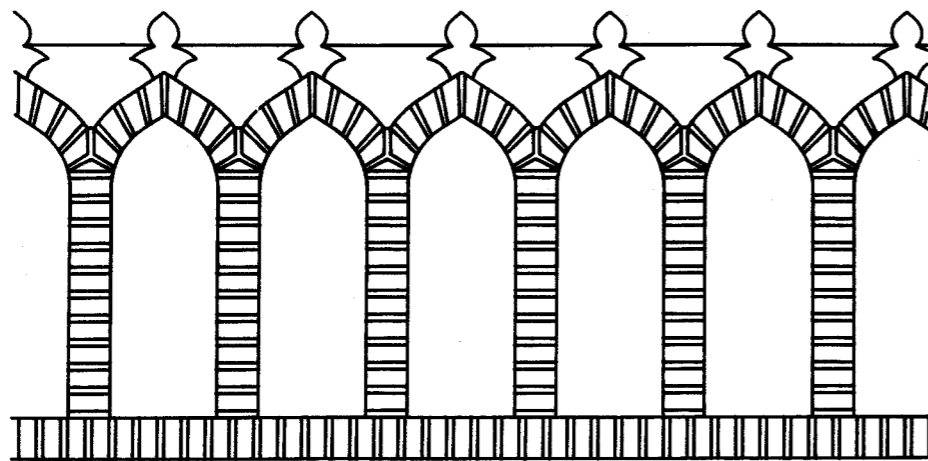

Fig. 8

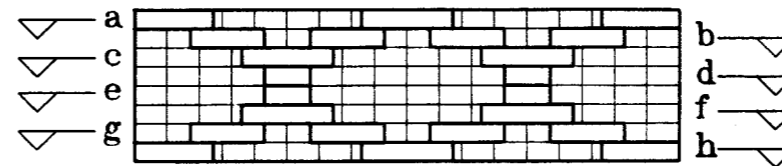

Fig. 9.a

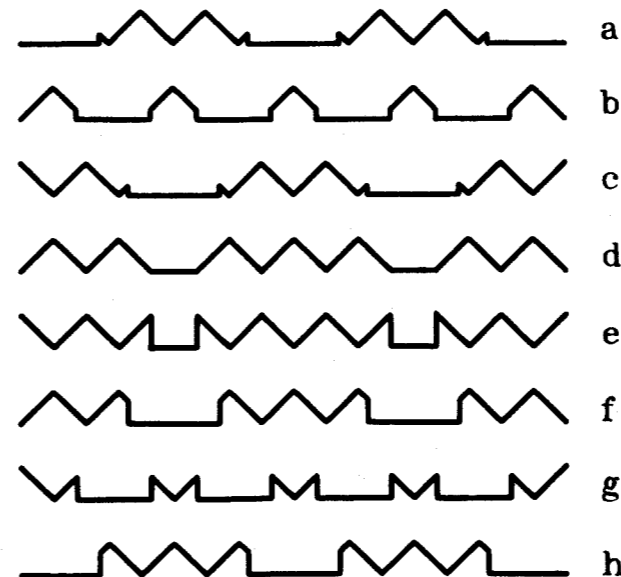

Fig. 9.b

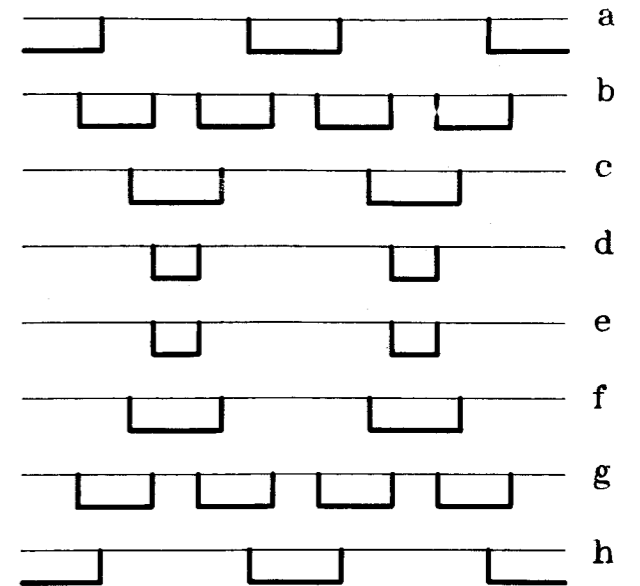

Fig. 9.c

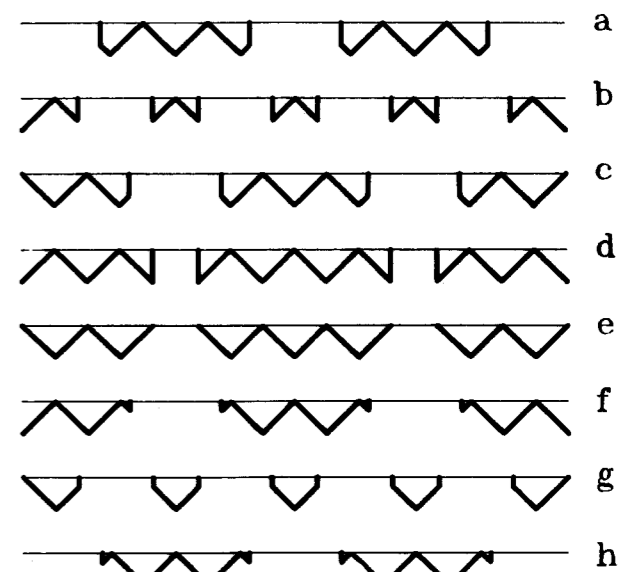

Fig. 9.d

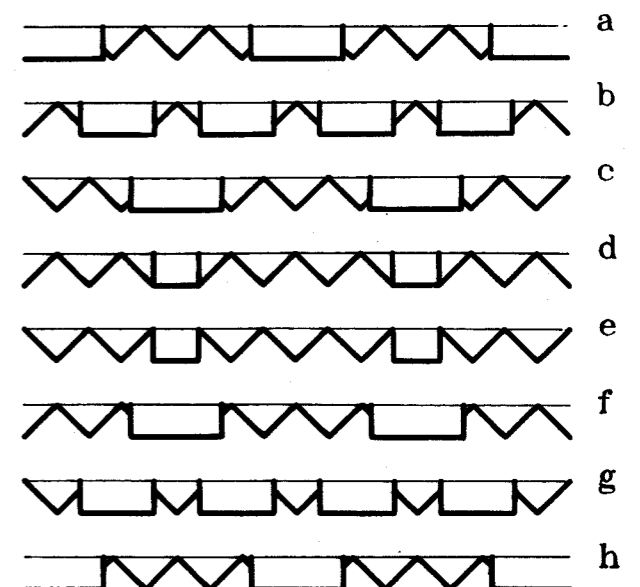

Fig. 9.e

ALMENADOS, CRESTERIAS, ANTEPECHOS Y BALCONES
ANTEPECHOS DENTELLADOS Y ARPADOS

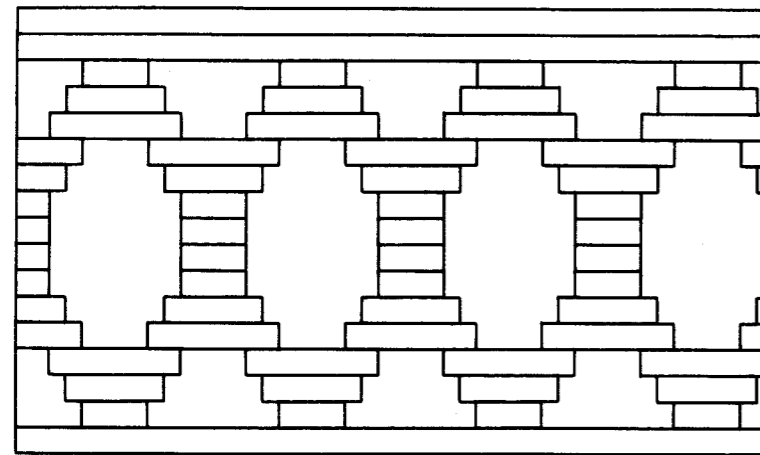

Fig. 1

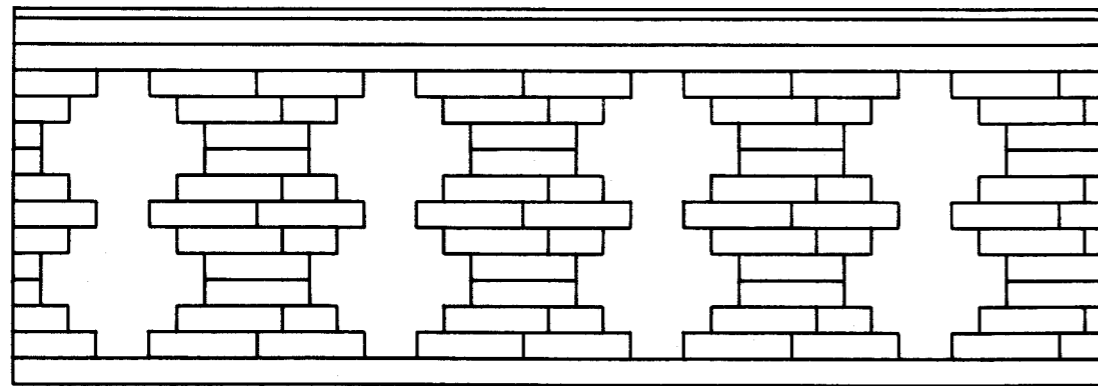

Fig. 2

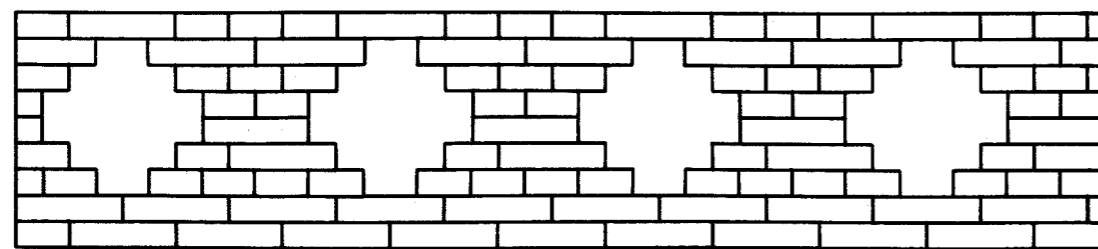

Fig. 3

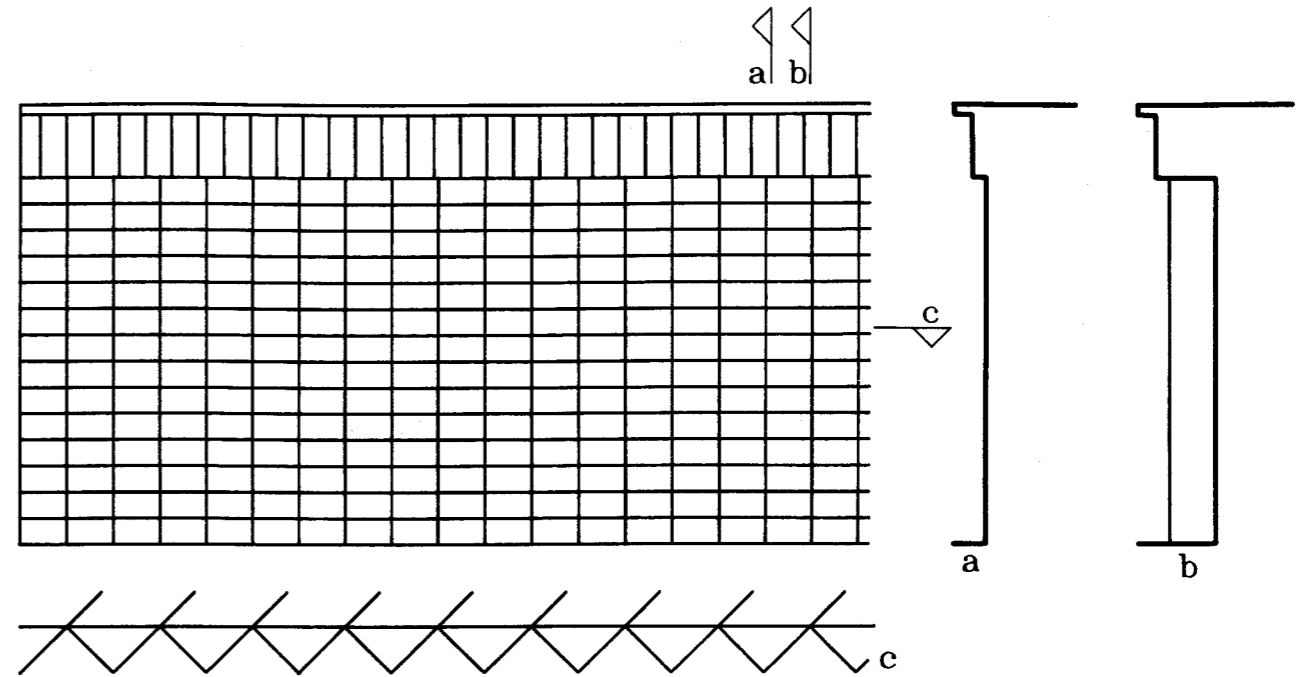

Fig. 4

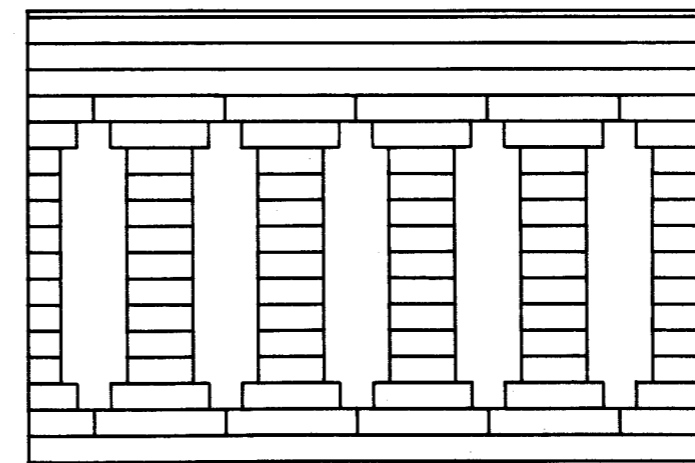

Fig. 5

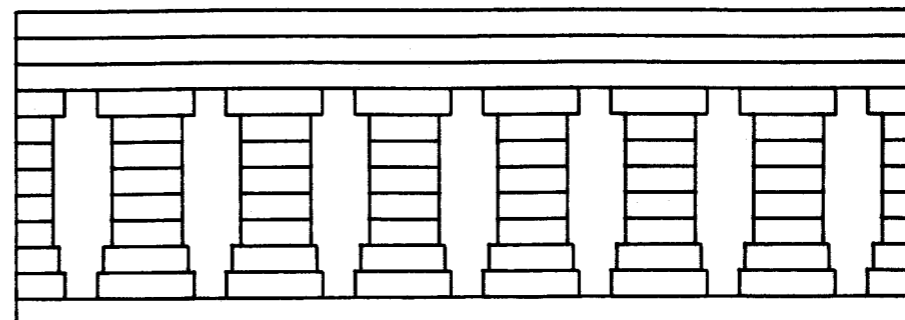

Fig. 6

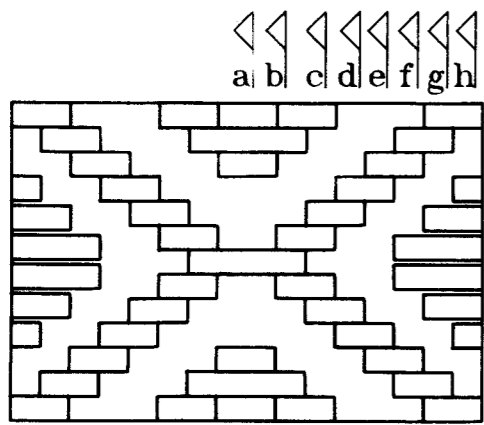

Fig. 1

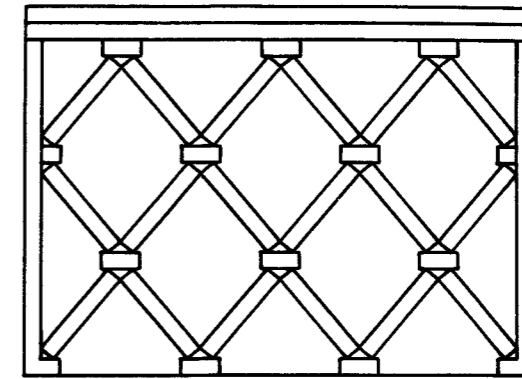
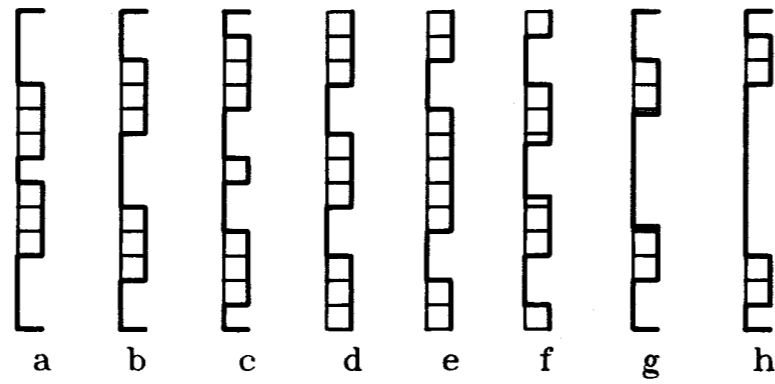

Fig. 4

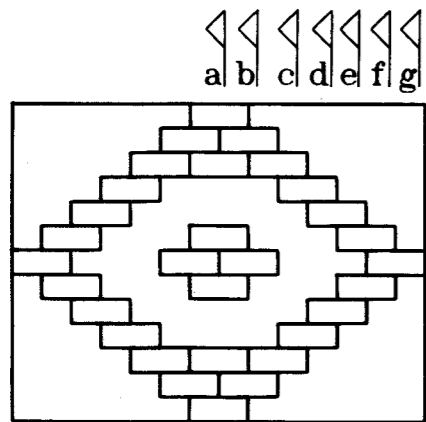

Fig. 2

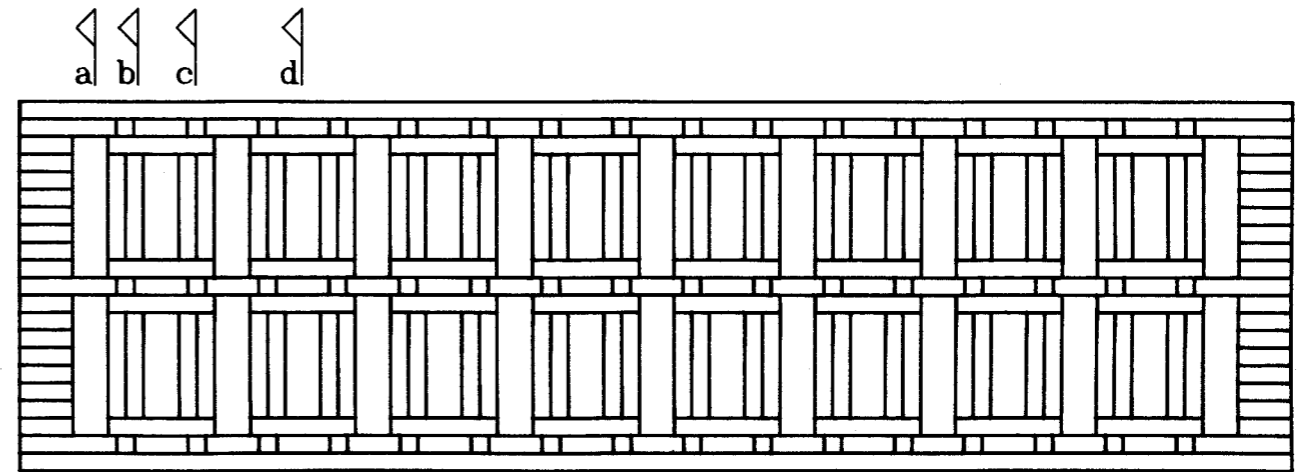
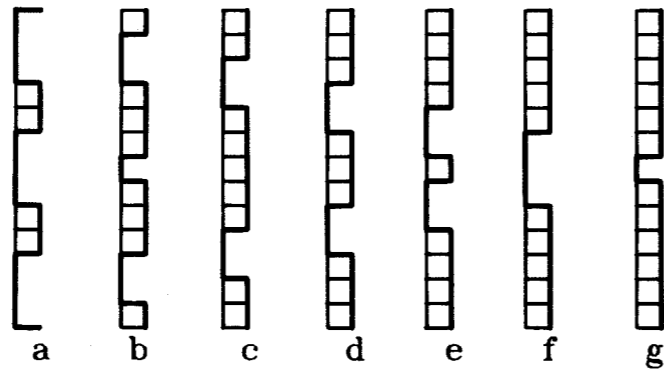

Fig. 5

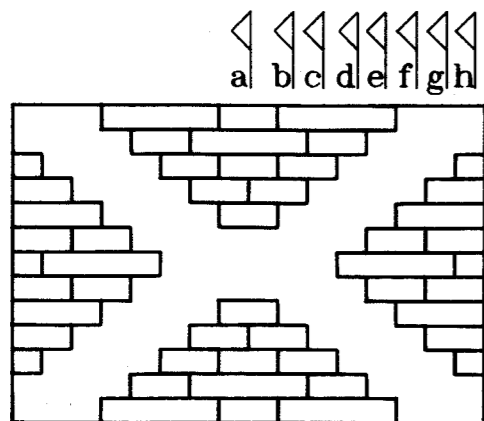
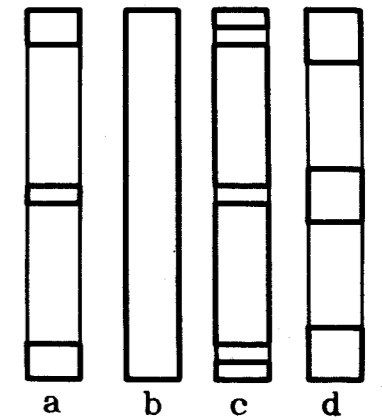
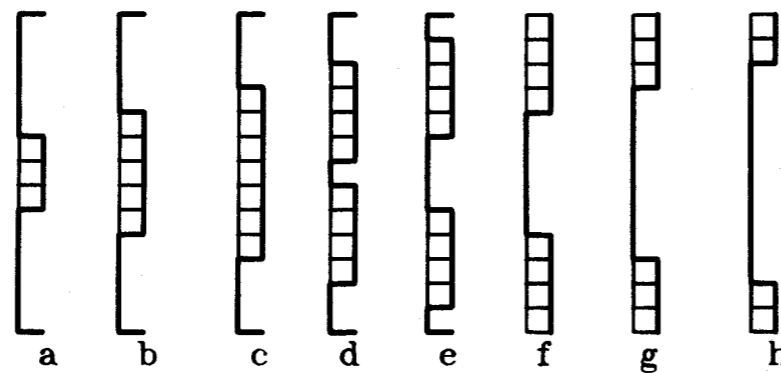

Fig. 3



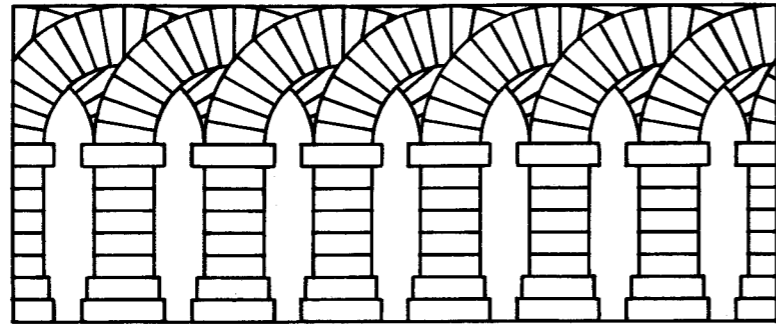

Fig. 1.a

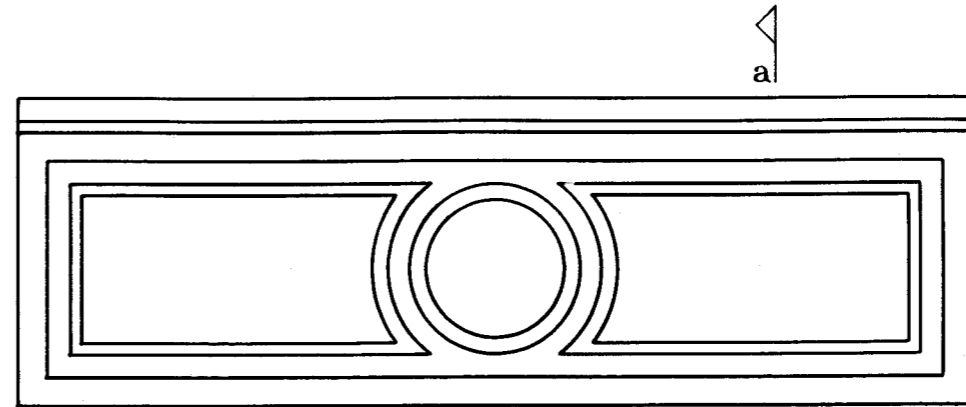

Fig. 2

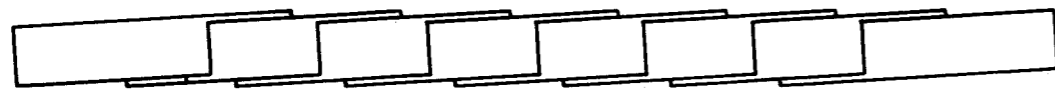
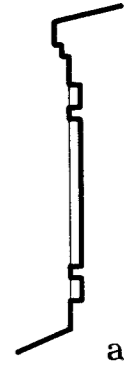

Fig. 1.b

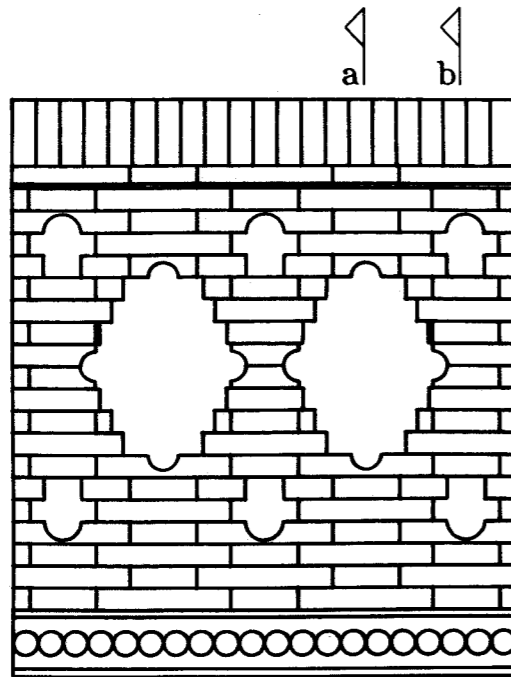

Fig. 3

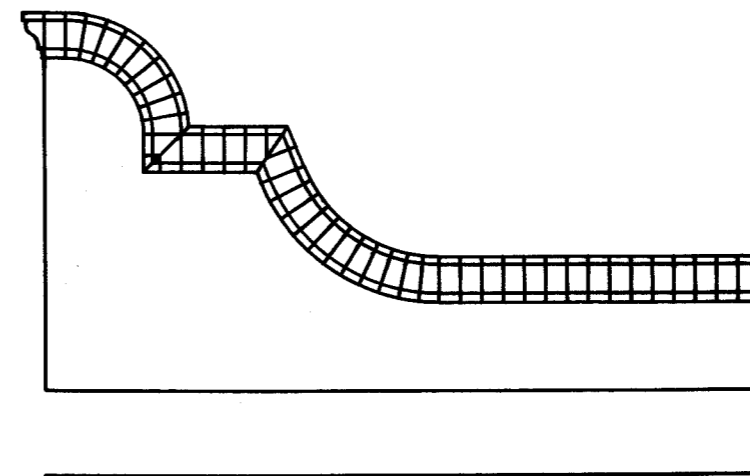
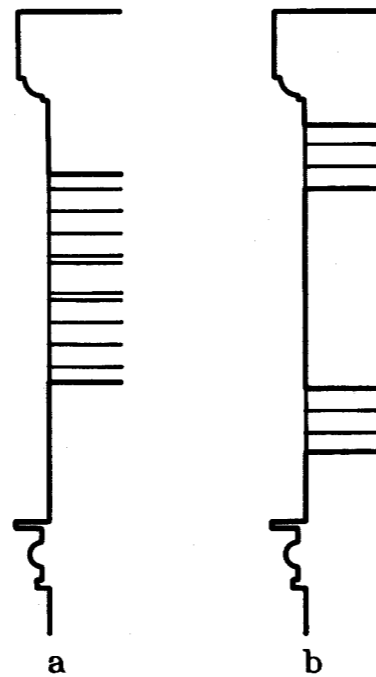

Fig. 4