

A 1.25V FGMOS Filter Using Translinear Circuits

Esther O. Rodríguez-Villegas, Adoración Rueda, Alberto Yúfera

Instituto de Microelectrónica de Sevilla (IMSE-CNM), Universidad de Sevilla,
Edificio CICA, c/ Tarfia s/n, 41012-SEVILLA, SPAIN.
emails: {esther, rueda, yufera}@imse.cnm.es

Abstract

This paper presents a new low voltage/low power filter design based on Floating-Gate MOS (FGMOS) transistors. FGMOS transistors are used as primitives to design linear and non-linear (\sqrt{x}) circuits. This technique enables a voltage reduction in strong inversion mode, and gives a new vision of the translinear principle, suitable for low voltage applications. Experimental results for a $0.8\mu\text{m}$ Low-Pass and Band-Pass filter prototype are reported.

1. Introduction

Low Power (LP) and Low Voltage (LV) circuits are nowadays widely demanded by the market of portable applications. Filters are building blocks appearing on demanded LP/LV products. The general interest existing now on LV/LP filters is leading this field towards large-signal processing to increase linearity and dynamic range [1-7]. This paper presents a LV/LP filter design technique that uses state-space description and FGMOS [8] circuits. This technique has a promising future in the LV analog design because of the possibility of compressing input signal levels and implementing a weighted sum of voltages in a simple form [9-11]. We will describe the design and test of a second-order filter for audio frequency applications working at 1.25V. The paper is organized as follows: Section 2 illustrates the modifications over the state-space equations, which lead to the filter implementation. The modified TransLinear (TL) principle when FGMOS transistors are used and the equations realization are introduced in Section 3. The developed theory will be applied to second-order filters in Section 4, reporting experimental results.

2. The State-Space Filter Equations

The time-dependent equations of any linear filter can be reduced to a set of first-order differential equations of the type,

$$\dot{x} + \alpha x = \eta x_i \quad (1)$$

where x is a state variable, x_i is the external excitation which can be an independent signal, other state-variable or any combination of both, and parameters α and η are related with

the filter specifications. For fully-differential operation, all signals (v_d) must be considered as the difference of a positive, x_p and a negative, x_n signal defined as: $x_p = x_{cm} + v_d/2$ and $x_n = x_{cm} - v_d/2$, respectively. The x_{cm} value is the common-mode level. Hence eq. (1) can be written as,

$$(\dot{x}_p - \dot{x}_n) + \alpha(x_p - x_n) = \eta(x_{ip} - x_{in}) \quad (2)$$

For voltage signals, we introduce the variable change,

$$V_p - V_n = \frac{I_p - I_n}{K\sqrt{I_c}} \quad (3)$$

where I_c, I_p, I_n are currents and K is a constant. By multiplying both sides in eq. (2) by C (physically an integrating capacitor), and using eq. (3), the LHS in eq. (2) can be identify as the current I through capacitor C ,

$$I = C(\dot{V}_p - \dot{V}_n) \quad (4)$$

This equation is symbolized in Fig. 1 with ideal elements.

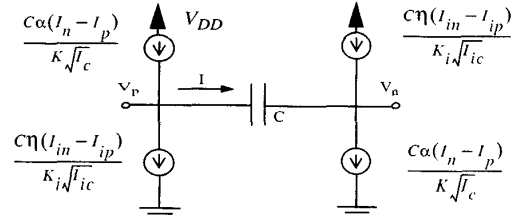

Fig.1: Ideal circuit schematic implementing the first-order state-space equations (3-4).

3. FGMOS Implementation

Here we describe the required circuits to implement the elements in Fig. 1 using FGMOS transistors [8]. A FGMOS transistor is a MOS transistor with isolated gate capacitively coupled to the inputs in a way that it is possible to have a weighted sum of these inputs at the floating gate (Fig. 2). In strong inversion, the drain-to-source current in saturation is,

$$I_D = \beta_n \left(\sum_{i=1, \dots, n} w_i V_i + w_B V_B - w_S V_S - w_T V_{th} \right)^2 \quad (5)$$

where β_n is the transconductance, V_{th} is the threshold voltage,

and the V_i are the input-voltage for the *FGMOS* transistor. The weights in eq. (5) are defined as: $w_i = C_i / C_T$, $w_B = C_{FB} / C_T$, $w_S = [1 - (C_{FB} / C_T) - 2/3(C_{ox} / C_T)]$, $w_T = [1 - 2/3(C_{ox} / C_T)]$, being C_T the total capacitance seen from the floating gate.

In weak inversion operation, the drain-to-source current in saturation region can be written as,

$$I_D = I_s \exp\left(\sum_i \frac{w_i V_i}{n U_T}\right) \quad (6)$$

where I_s is a current which depends on both technological and design parameters, U_T is the thermal voltage, n is the slope factor, and the weights are defined in the same way as in eq. (5). Equation (6) allows the use of *FGMOS* transistors in TransLinear circuits.

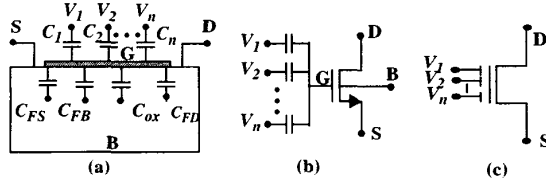

Fig.2: *FGMOS*: (a) Capacitors model. (b) Equivalent circuit. (c) Schematic.

A: Circuit for variable change.

Let's consider the circuit in Fig. 3a with three equal *FGMOS* transistors in saturation strong inversion region. The drain-to-source currents of transistors *M1* and *M2* are,

$$I_{p,n} = \beta(w_{DD} V_{DD} + w V_{p,n} - V_{th})^2 \quad (7)$$

where subscripts p and n apply to *M1* and $M2$ respectively. Taking the difference between I_p and I_n gives,

$$(V_p - V_n) = \frac{(I_p - I_n)}{2w\sqrt{\beta}I_c} \quad (8)$$

representing the variable change performed over the state-space equation as defined in eq. (3). I_c is defined as the *common-mode current* derived from V_p and V_n . It senses the common-mode voltage, V_{cm} , of both voltage signals. Circuit in Fig. 3a generates, from V_p and V_n voltages, three currents I_p , I_n and I_c involved in the variable change in eq. (3). As eq. (8) represents a non-linear relationship between voltages and

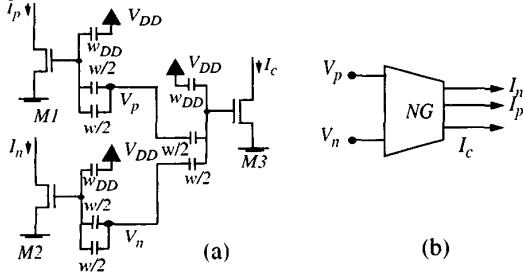

Fig.3: (a) *FGMOS* circuit for variable-change. (b) Symbol.

currents, we will refer to this circuit as a transconductor or *NG-circuit*. Its symbol is shown in Fig. 3b. Each *NG-circuit* has a large-signal differential input-voltage to differential output-current transconductance given by, $G = 2w\sqrt{\beta}I_c$, where I_c is the common-mode current. As it is demanded by eq. (8), the circuit required is an y/\sqrt{x} -type operator, and can be derived using the translinear principle.

B: *FGMOS* Translinear Principle.

Let's consider two *FGMOS* transistors *M0* and *M1* with grounded source and a common input V_{0i} at *M0* and V_{1j} at *M1* (Fig. 4). The Kirchoff's voltage law in this trivial loop is:

$$-V_{0i} + V_{1j} = 0 \quad (9)$$

Expressing voltages in the *TL* loop as functions of the currents flowing through the transistors gives:

$$V_{0i} = n U_T \ln\left(\frac{I_{0i}}{I_s}\right)^{1/w_{0i}} - \frac{1}{w_{0i}} \cdot \sum_{k \neq i} \frac{w_{0k} V_{0k}}{n U_T} \quad (10)$$

$$V_{1j} = n U_T \ln\left(\frac{I_{1j}}{I_s}\right)^{1/w_{1j}} - \frac{1}{w_{1j}} \cdot \sum_{k \neq j} \frac{w_{1k} V_{1k}}{n U_T}$$

Substituting them into equation (9) and solving, it results

$$\left(\frac{I_{0i}}{I_s}\right)^{1/w_{0i}} e^{-\sum_{k \neq i} \frac{w_{0k} V_{0k}}{w_{0i} n U_T}} = \left(\frac{I_{1j}}{I_s}\right)^{1/w_{1j}} e^{-\sum_{k \neq j} \frac{w_{1k} V_{1k}}{w_{1j} n U_T}} \quad (11)$$

This is a non-linear relationship between currents which is the objective of the *TL* principle. The advantage of designing *TL* loops with *FGMOS* devices is that it is possible to implement the exponents in (11) through capacitance ratios. This fact makes this transistor very useful for *LV* purposes.

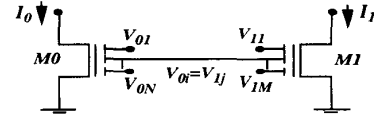

Fig.4: *FGMOS* Translinear Loop.

C: The y/\sqrt{x} circuit.

The currents added in the integrating capacitor must be divided by the squared-root of I_c , or common-mode current for each pair of differential voltages. This operator can be also implemented by means of *TL* circuits [8]. In eq. (3), each RHS term follows the general form,

$$\frac{1}{K\tau} \cdot \frac{I_d}{\sqrt{I_c}} \quad (12)$$

with $\tau = \alpha^{-1}$ or η^{-1} , $K = 2w\sqrt{\beta}$, and $I_d = I_p - I_n$. Multiplying eq. (2) by an integrating capacitor, and using eq.(3), gives a dimensionally correct equality,

$$\frac{C}{K\tau} = \frac{C}{2w\sqrt{\beta}\tau} \equiv A_j \sqrt{I_{A_j}} \quad (13)$$

being A_j a non-dimensional factor and I_{A_j} an independent

current. An alternative form of eq. (4) is thus obtained,

$$C(\dot{V}_p - \dot{V}_n) = -A_j \sqrt{I_{A_j}} \frac{I_d}{\sqrt{I_c}} + A_i \sqrt{I_{A_i}} \frac{I_{di}}{\sqrt{I_{ci}}} \quad (14)$$

For the implementation of this equation, two I_{A_j} currents are required, for coefficients α and η . The proposed circuit is shown in Fig. 5a. Voltage sources are employed at *FGMOS* inputs for shifting the threshold voltage and controlling the circuit gain. The corresponding output current for the circuit are now given by the equation,

$$I_{on/op} = A_j \sqrt{I_{A_j}} \cdot \frac{I_{n/p}}{\sqrt{I_c}} \quad (15)$$

where A_j depends on the constant reference voltage sources placed at the input of the transistors. For equal total capacitance for any *FGMOS* transistor, and for all voltages sources equal to V_{DD} , (except V_{A_j}), the A_j constant is given by,

$$A_j = e^{(V_{A_j} - V_{DD})/4nU_t} \quad (16)$$

where the independent voltages are chosen to ensure weak inversion operation and V_{A_j} is selected for A_j -tuning. This gives us a design relationship between the state-space equation coefficients, the selected integrating capacitor, and the floating-gate circuits:

$$\frac{C}{2w\sqrt{I_{A_j}}\sqrt{\beta}} \cdot e^{-(V_{A_j} - V_{DD})/4nU_t} = \tau \quad (17)$$

Negative $I_{on/op}$ values are implemented with current mirrors.

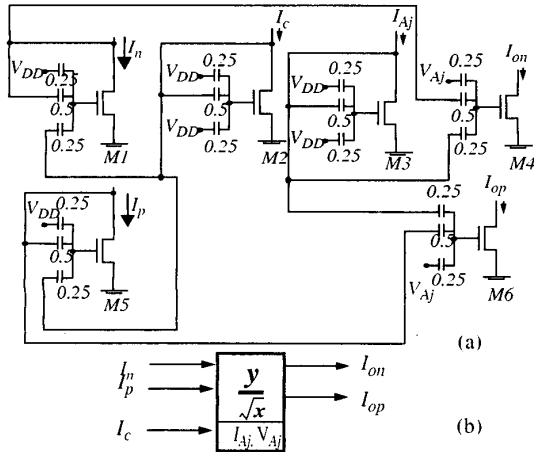

Fig.5: (a) y/\sqrt{x} circuit based on *FGMOS TL* loops. (b) Symbol.

D: The transconductor

The circuit for implementing each term in the state-space equation is shown in Fig. 6. It realizes a linear relationship between the output current I_{on} - I_{op} and the differential voltage V_p - V_n , so it fits to a linear transconductor description. Its transconductance is given by:

$$g_m = C/\tau = 2wA_j\sqrt{\beta I_{A_j}} \quad (18)$$

The value of g_m can be adjusted by mean of an external current or external voltages through A_j and I_{A_j} values.

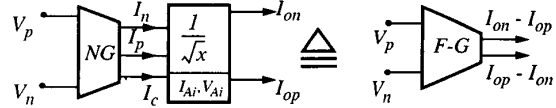

Fig.6: The *FGMOS* transconductor (*F-G*).

4. A Second-Order Filter

The design procedure exposed in section 3 has been used to implement a second order filter. The specifications of the filter are in the audio frequency range. The power supply is below 1.25V, in a 0.8 μ m *CMOS* process with threshold voltages of $V_{tn}=0.8V$ and $V_{tp}=-0.82V$. The starting point for the design are the equations,

$$\dot{x}_1 = -\omega_{o1}x_1 - \omega_{o2}x_2 + \omega_{o3}x_i \quad (19)$$

$$\dot{x}_2 = \omega_{o2}x_1 \quad (20)$$

Three parameters have been taken in order to increase filter programmability. The ω_o and Q of the second-order filter are given by,

$$\omega_o = \omega_{o2}, Q = \omega_{o2}/\omega_{o1} \quad (21)$$

and the maximum gains,

$$H_{LP}(0) = \omega_{o3}/\omega_{o2}, H_{BP}(\omega_o) = \omega_{o3}/\omega_{o1} \quad (22)$$

The circuit implementing equations (19-20) is shown in Fig. 7, where,

$$H_{LP}(0) = H_{BP}(\omega_o) = \sqrt{\frac{I_{A3}}{I_{A2}}} \cdot \frac{A_3}{A_2} \quad (23)$$

$$\omega_o = \frac{2w\sqrt{\beta}}{C} \cdot A_2 \cdot \sqrt{I_{A2}} \quad (24)$$

$$Q = \sqrt{\frac{I_{A2}}{I_{A1}}} \cdot \frac{A_2}{A_1} \quad (25)$$

Tuning of ω_o and Q can be performed through either the reference voltages or the independent current sources, the ω_o frequency will be constant if V_{A2} is not changed, while Q can take some values depending on I_{A_i} or V_{A_i} values. Outputs of this circuit can be currents I_1 and I_2 through both capacitors or the differential voltage across them.

Filter parameters in eqs. (21-22) can be controlled by design equations (23-25). A value of 3.4pF for capacitors has been used. For the *NG-circuits* we have chosen $\beta=30.7\mu A/V^2$, for *M1-M3 FGMOS* transistors in Fig. 3, and 50fF and 100fF for input capacitors with weight 0.25 and 0.5, respectively. Fig. 8 (illustrates the obtained *LP* and *BP* transfer functions. Fig. 9 shows the Q and gain programming for both transfer functions. The distortion for the *LP*-function with a cut-off frequency of 2KHz can be observed in Fig. 10, for a sinusoidal input signal of 200Hz. The maximum value is 41dB for half range of the power supply. The *IM3* parameter for the *BPF* is below 40dB when both input signals have amplitudes smaller

than 0.5V. It has been also measured the performance of the filter when the input common-mode change. The CMR measured is of 0.6V. Performance results are summarized in Table1.

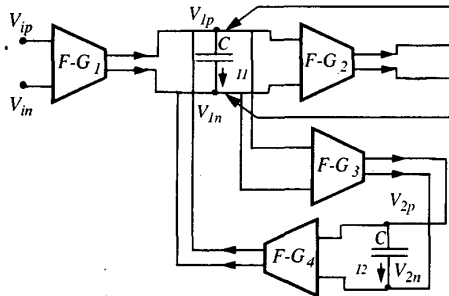

Fig.7: Proposed 2^o-order filter.

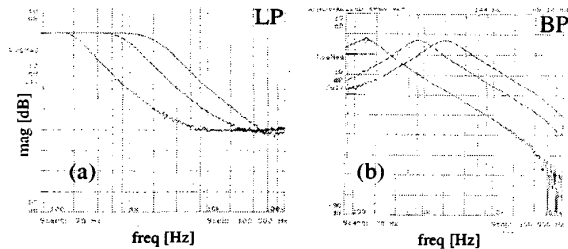

Fig.8: Experimental LP and BP filter responses.

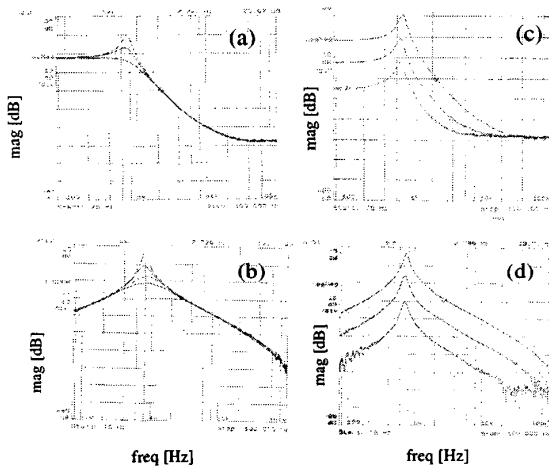

Fig.9: Q-tuning. for LP (a) and BP (b) functions. Gain-tuning. for LP (c) and BP (d) functions for $f_o = 0.75\text{KHz}$.

5. Conclusions

A new LV/LP band pass/low pass biquad realization has been proposed. The design shows the feasibility of the FGMOS devices to scale down the power supply either in weak inversion or in strong inversion operation modes. A 1.25V filter prototype have been tested which exhibits a quite large dynamic range, more than one decade tuning rate and a power consumption of a few microwatts.

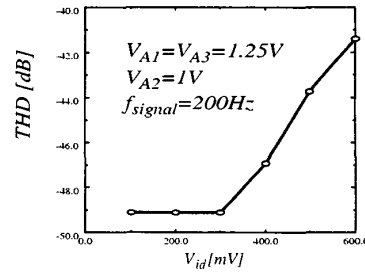

Fig.10: THD versus differential input amplitude.

Table 1: Summary of the 2^o-order filter performance.

Power Supply	1.25V
Area	0.23mm ²
f_o	100Hz - 2KHz
Q	0.75 - 7
$THD_{max}(V_{pp} < 1V @ 200Hz, Q=1, H_{LP}(0)=1, f_o=900Hz)$	< 40dB
$IM3(V_{pp1}=V_{pp2} < 0.5V @ 200Hz, Q=1, H_{LP}(0)=1, f_o=900Hz)$	< 40dB
Noise in band	-75dB
DR (@ 1%THD)	78 - 62 dB
Power	2.5 μ W

6. References

- [1] C. Yoo, S. Lee and W. Kim: "A $\pm 1.5V$, 4-MHz CMOS Continuous-Time Filter with a Single-Integrator Based Tuning". *IEEE JSSC*, Vol. 33, N^o 1, pp. 18-27, Jan. 1998.
- [2] A. Yúfera, and A. Rueda: "Programmable Low-Voltage Continuous-Time Filter for Audio Applications". *ISCAS*, pp. 200-203, May, 1999.
- [3] H. Tanimoto, M. Koyama, and Y. Yoshida: "Realization of a 1V Active Filter Using Linearization Technique Employing Plurality of Emitter-Couple Pairs". *IEEE JSSC*, Vol.26, pp.937-945, Jul., 1991.
- [4] D. R. Frey: "Log-domain filtering: an approach to current-mode filtering". *Proc. IEE VOL. 140*, Pt. G, N^o 6, pp. 406-416, Dec. 1993.
- [5] W. A. Serdijn, et al.: "A Low-Voltage Ultra Low-Power Translinear Integrator for Audio Applications". *IEEE JSSC*, Vol.32, pp.577-581, Apr. 1997.
- [6] C. Toumazou, J. Ngarmnil and T. S. Lande: "Micropower log-domain filter for electronic cochlea". *Electronics letters*, Vol. 30, N^o. 22, pp. 1834-1841, Oct. 1990.
- [7] D. Python, M. Punzenberger and C. Enz: "A 1V CMOS Log-Domain Integrator". *ISCAS*, Vol: II, p: 685-688, May 1999.
- [8] B. A. Minch: "Analysis, Synthesis, and implementation of Networks of Multiple-Input Translinear Elements", *Ph.D. Thesis*, Caltech, Pasadena, CA, 1997.
- [9] E.O. Rodríguez, G. Huertas, J.M. Quintana, M.J. Avedillo and A. Rueda: "A Practical Floating-Gate Muller-C Element Using CMOS Threshold Gates". *IEEE Trans. on CASII*, *Special Issue on Floating Gate Circuits and Systems*, (to appear in 2001).
- [10] E. O. Rodríguez, A. Yúfera and A. Rueda, "A Low-Voltage Sqrt-Root Floating-Gate MOS Integrator", *ISCAS*, pp:184-187, Jun. 2000.
- [11] E.O. Rodríguez, A. Rueda and A. Yúfera: "Low-Voltage Analog Filters Using Floating-Gate MOSFETs". *ESSCIRC*, pp. 68-71, Sep. 2000.