

OZONE PRODUCTION BY CORONA DISCHARGE USING A HOLLOW NEEDLE-PLATE ELECTRODE SYSTEM

F. PONTIGA^{1*}, K. HADJI², M. GUEMOU², K. YANALLAH², A. FERNÁNDEZ-RUEDA¹,
H. MORENO¹

¹Dpt. Física Aplicada II, Universidad de Sevilla, Sevilla, 41012, Spain

²Lab. de Génie Electrique et des Plasmas, Université Ibn Khaldoun, Tiaret, 14000, Algeria

*pontiga@us.es

ABSTRACT

Ozone generation using a hollow needle-to-plate corona reactor has been investigated using both positive and negative polarities and various flow rates. Oxygen could be introduced in the reactor either through the needle electrode or through a port on the lateral wall. This configuration allowed studying the effect of the flow direction on ozone production.

1. INTRODUCTION

The exceptional oxidizing character of ozone is on the basis of its many applications in very different fields, such as in the treatment of water, the disinfection of cold stores, food storage, air deodorization, flue gas treatment, etc. Ozone can be easily produced using a variety of electrical discharges. [1, 2]. Among them, corona discharge can be a suitable source of ozone when small or moderate ozone concentrations are required. Typical electrode arrangements of DC and pulsed corona discharge reactors include coaxial wire-to-cylinder, parallel wire-plate, and perpendicular point/multipoint-to-plate configurations.

Hollow needle-to-plate is a common variation of point-to-plate configuration [2]. In that case, the gas is supplied through the needle and passes through the discharge region, where it is exposed to the plasmachemical processes initiated by the electrical discharge [3, 4]. Usually, these experiments are carried out using high gas flow rates (> 10 litres/min), since this helps to stabilize the electrical discharge. Thus, corona currents of several mA can be registered without sparking. In contrast, the present study will be focus on ozone production using moderate flow rates (< 1 litre/min) and small corona currents

(< 0.1 mA). Therefore, corona discharge will be operated within the glow regime, before entering the streamer mode. Both positive and negative polarity will be considered. Also, the influence of the gas flow direction on ozone generation will be analyzed.

2. EXPERIMENTAL SET-UP

A schematic picture of the experimental set-up used during the experiments is shown in figure 1. The corona discharge was generated using a stainless steel needle with a sharp bevelled curved tip, as shown in figure 2 (Hamilton, gauge 22). The outer and inner diameters of the needle were 0.72 mm and 0.41 mm, respectively. The tip of the needle was situated 7 mm apart from a stainless steel circular disc, with radius 2 cm. Chlorinated polyvinyl chloride (CPVC) was used as insulating material for the walls of the corona reactor. Negative or positive high voltage was applied to the needle in the range

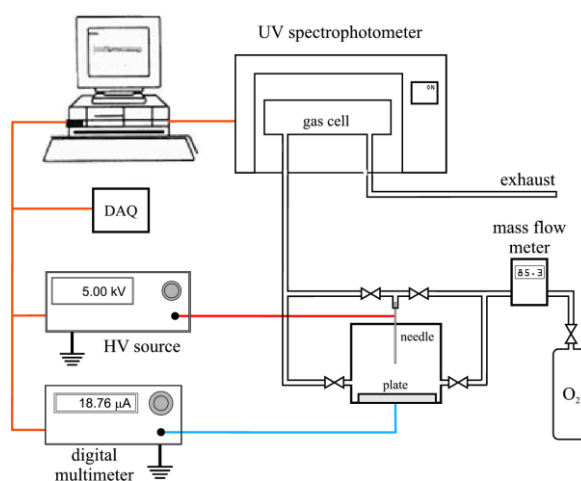

Fig. 1. Schematic representation of the experimental set-up used during the experiments.



Fig. 2. Detailed picture of the needle point used in the experiments.

4.5 kV to 9.5 kV using a Trek 610 HV amplifier. The circular electrode was grounded through a Keithley 196 digital multimeter to register the corona current.

The entry of the gas flow to the corona discharge reactor could be switched from the needle to a lateral port on the wall by operating two valves. Similarly, the gas could exit the reactor either from the needle or from another port on the lateral wall. Therefore, three different gas flow directions have been investigated: (1) needle to lateral port, (2) lateral port to needle, and (2) lateral port to lateral port. The flow rate was controlled by means of a mass flowmeter (Alicat).

Before the start of the experiment, the corona reactor was purged for five minutes with pure oxygen (99.995% purity). Then, the high voltage was applied for 15 minutes and the concentration of ozone in the effluent gas was monitored every three minutes using a UV/VIS spectrophotometer (Thermo Evolution 300). The spectral absorbance of the gas, A , was measured in the range of wavelengths 190-330 μm , using a bandwidth of 1 nm. Ozone concentration was derived using Beer-Lambert law,

$$A(\lambda) = L \sigma(\lambda) N \log_{10}(e)$$

where N is the particle density of the absorbing species (ozone), $\sigma(\lambda)$ the absorption cross section at the wavelength λ , and L the path length of the gas cell ($L \approx 48$ mm). The value of N was determined using least square fitting. All tubing was made of polytetrafluoroethylene (PTFE), in order to minimize ozone decomposition during the transfer of the gas from the corona reactor to the gas cell inside the spectrophotometer.

3. RESULTS

Figures 3 and 4 show the current-voltage characteristics corresponding to negative and positive polarity of the needle electrode, respectively. In each figure, the results for three different flow rates ($Q = 100, 150$ and 200 cm^3/min) and for the

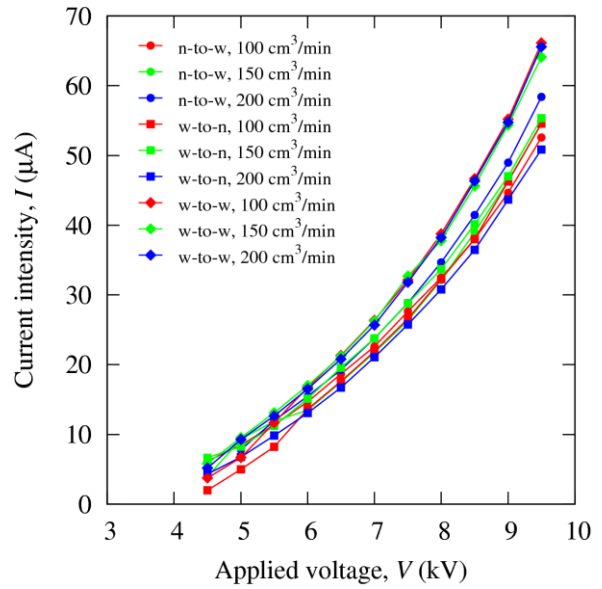

Fig. 3. Negative corona current-voltage characteristic for different gas flow rates and flow directions. *n-to-w*: needle (entry) to lateral port (exit), *w-to-n*: lateral port (entry) to needle (exit), *w-to-w*: lateral port (entry) to opposite lateral port (exit).

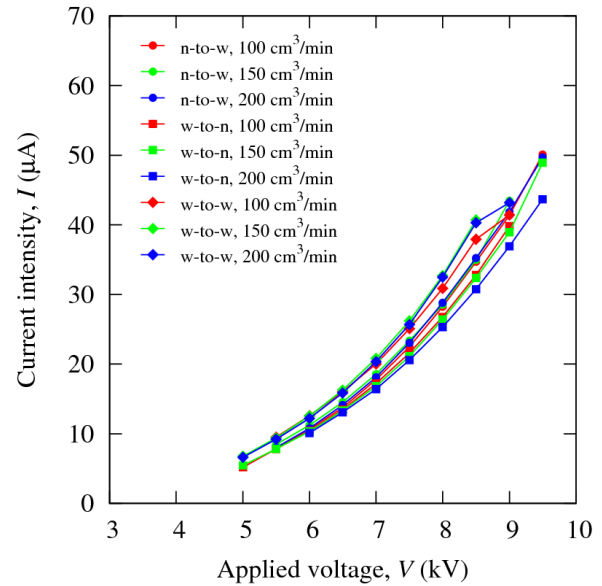

Fig. 4. Positive corona current-voltage characteristic for different gas flow rates and flow directions. *n-to-w*: needle (entry) to lateral port (exit), *w-to-n*: lateral port (entry) to needle (exit), *w-to-w*: lateral port (entry) to opposite lateral port (exit).

three possible flow directions are presented. The gas velocity within the needle ranged from 12.6 m/s to 25.2 m/s.

Both for positive and negative polarities, the corona current exhibits a parabolic dependence with the current intensity, and it is rather insensitive to the gas flow rate. However, the current intensity was higher when the flow of the gas was perpendicular to the needle electrode (entry and exit through lateral ports). In that case, and

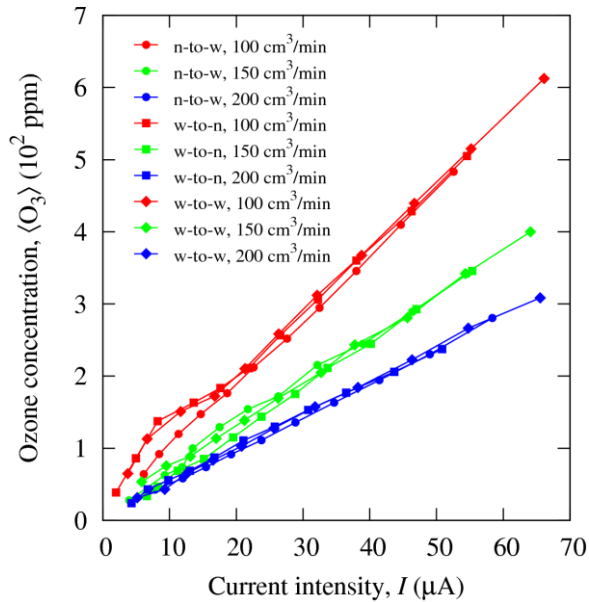

Fig. 5. Ozone concentration as a function of the current intensity (negative corona) for different gas flow rates and flow directions. *n-to-w*: needle (entry) to lateral port (exit), *w-to-n*: lateral port (entry) to needle (exit), *w-to-w*: lateral port (entry) to opposite lateral port (exit).

for positive polarity, transition to streamer/spark was also observed at 9.5 kV. Therefore, the introduction of the gas through the needle confirms the stabilizing effect played by the gas flow on the positive corona current.

Ozone concentration for negative polarity is presented in figure 5 as a function of the corona current intensity. Clearly, the growth of ozone concentration is linear with the current intensity, and it is little influenced by the direction of the gas flow for the range of parameters here considered. This behaviour can be understood by noticing that the residence time of the gas within the reactor is of the order of tens of seconds, since the volume of the discharge reactor is about 37 cm³. Therefore, the gas within the reactor will recirculate driven by electrohydrodynamic forces (the ionic wind is of the order of meters per second [5]) and it may approach the active region of the corona discharge many times before leaving the reactor.

Figure 6 shows the ratio of ozone concentration to the gas flow rate as a function of the corona current for negative polarity. This ratio gives the number of ozone molecules leaving the ozone reactor per unit of time, which is essentially identical for all flow rates and flow directions.

In contrast to negative polarity, ozone generation by positive corona discharge is not linear with

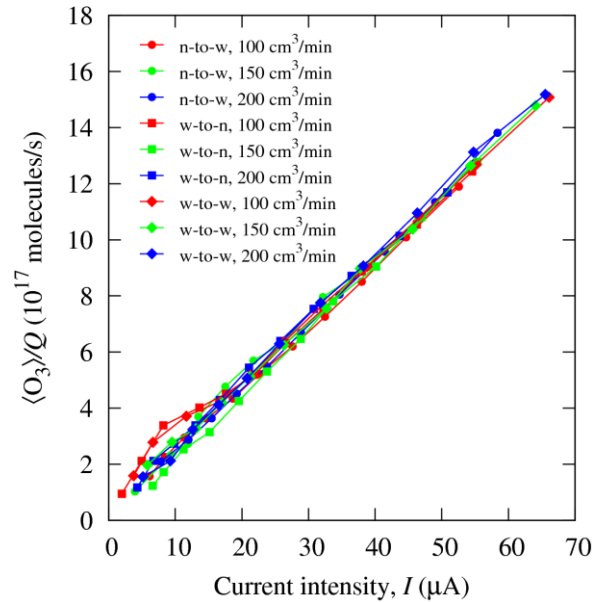

Fig. 6. Rate of ozone generation as a function of the current intensity (negative corona) for different gas flow rates and flow directions. *n-to-w*: needle (entry) to lateral port (exit), *w-to-n*: lateral port (entry) to needle (exit), *w-to-w*: lateral port (entry) to opposite lateral port (exit).

the current intensity, as can be clearly appreciated in figure 7. At low current intensities, the ozone concentration levels obtained with positive corona are lower than with negative corona, and the opposite is true for corona currents above 35 μA. In the streamer regime, positive corona is known to produce more ozone than negative corona. Therefore, this observation may indicate the progressive transition from the glow mode to the streamer mode as the applied voltage is increased.

Moreover, the direction of the gas flow has a certain influence on ozone generation, although there is not a clear trend. At 100 and 150 cm³/min, the best efficiency for ozone production is observed when the gas flow is perpendicular to the needle. However, at 200 cm³/min, the highest ozone concentration was found when oxygen is introduced through the needle.

Figure 8 shows that the rate of ozone production increases with the corona current at a power slightly higher than two. Unlike the negative corona, the data corresponding to the different experiments do not converge in a single line, due to the dependence with the direction of the gas flow already mentioned.

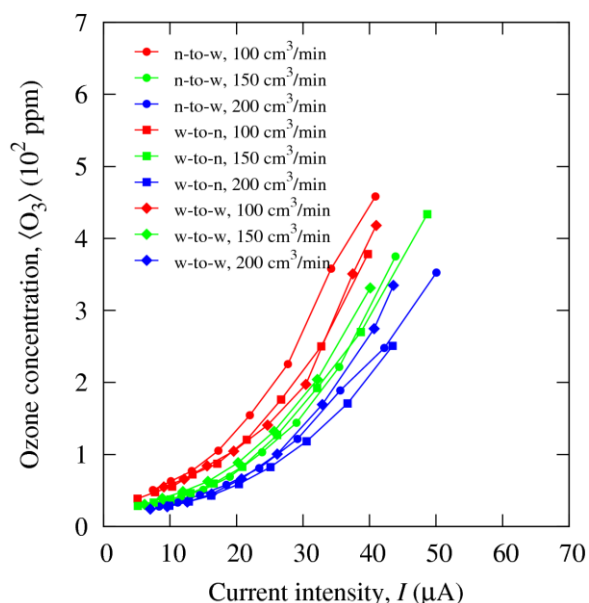

Fig. 7. Ozone concentration as a function of the current intensity (positive corona) for different gas flow rates and flow directions. n-to-w: needle (entry) to lateral port (exit), w-to-n: lateral port (entry) to needle (exit), w-to-w: lateral port (entry) to opposite lateral port (exit).

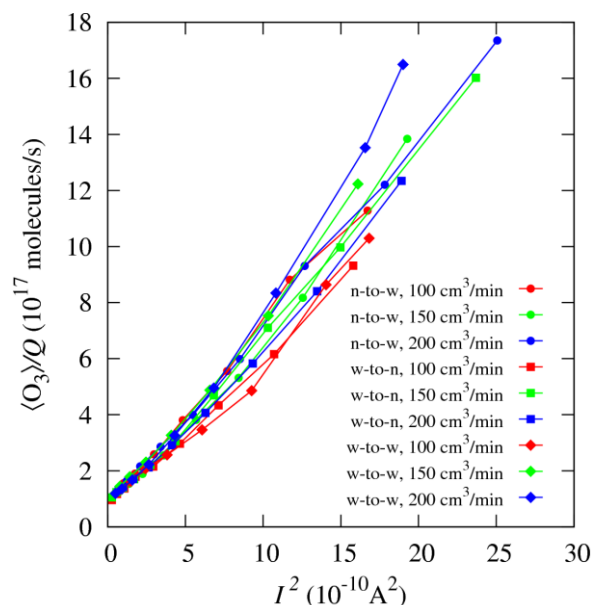

Fig. 8. Rate of ozone generation as a function of the square of current intensity (positive corona) for different gas flow rates and flow directions. n-to-w: needle (entry) to lateral port (exit), w-to-n: lateral port (entry) to needle (exit), w-to-w: lateral port (entry) to opposite lateral port (exit).

3. CONCLUSIONS

Positive and negative glow corona in hollow needle-to-plate electrode configuration have been investigated using moderate flow rates and different flow directions. The results for negative corona indicate that the direction of the flow has no influence on ozone generation, and that the rate of ozone production is unaffected by the gas flow rate. In contrast, positive corona is much less regular, and the ozone generation seems to be affected both by the gas flow and the flow direction. Initially, ozone production for positive polarity is smaller than for negative polarity but, eventually, at higher currents, positive corona becomes more efficient for producing ozone.

REFERENCES

- [1] H.-H. Kim, "Nonthermal plasma processing for air-pollution control: a historical review,

current issues, and future prospects" *Plasma Processes and Polymers*, **1**, 91–110, 2004

- [2] S. Pekárek, "Non-Thermal Plasma Ozone Generation", *Acta Polytechnica*, **43**, 47-51, 2003.
- [3] S. Pekárek, V. Kriha, M. Simek, R. Balek and F. Hanitz, "Hollow needle-to-plate electrical discharge at atmospheric pressure", *Plasma Sources Sci. Technol.* **8**, 513–518, 1999.
- [4] S. Pekárek, "Effect of polarity on ozone production of DC corona discharge with and without photocatalyst", 19th International Symposium on Plasma Chemistry, Bochum, 2009.
- [5] T. Adachi, "Ionic wind in the electrostatic precipitator—Experimental treatment by Schlieren Method", *Electrical Engineering in Japan*, **93**, 43-49, 1873.