

## MODELLING AND PID CONTROL OF A ROTARY DRYER

F.R. Rubio, C. Bordons, J. Holgado and R. Arjona

*Escuela Superior de Ingenieros, Universidad de Sevilla  
Camino de los Descubrimientos s/n, 41092-Sevilla (Spain)  
Phone: +34954487350, Fax: +34954487340,  
E-mail: rubio@esi.us.es*

**Abstract:** This paper describes the modelling and the PID control of a drying process. The plant uses a co-current rotary dryer to evaporate moisture of a waste product generated by olive-oil mills, called *alpeorujo* or *two phase cake*. The paper shows the development of a model based upon first principles combined with experimental results. A control strategy has been tested under simulation based on PID controllers for the main loops in this process. *Copyright ©2000 IFAC*

**Keywords:** Industrial control, Food processing, PID control, Modelling.

### 1. INTRODUCTION

The modern *two phase* olive-oil mills generate a waste called *alpeorujo* or *two phase cake*, that has to be dried before feeding it into the leaching system in order to extract the remaining oil. The high degree of humidity in *alpeorujo* has led to serious operational problems (blockade, fires, low thermal efficiency, etc.) and is forcing oil producers to introduce automatic control capabilities in their drying plants.

In this kind of process (Shinsky, 1996), it is common to use continuous rotary dryers in which the material is tumbled, or mechanically turned over with a high temperature air flow in the same direction. Because the moisture content of solids is not an easy measurement, indirect measurement techniques are used for control purposes. Even if a reliable analyzer is available, it is preferred to control the dryer on the basis of a temperature based inferential system (and use the analyzer only to update the inferential model). This is because information on load changes can be obtained sooner on the basis of air temperature than on moisture. Therefore the most advanced dryer controls use the analyzers for feedback trimming of the faster,

and partially feedforward, inferential temperature models (Liptak, 1998).

The prime control requirement is to maintain the outlet moisture of the product at a constant value. Since the inlet moisture and properties of the product can be variable, the objective can be achieved by the adjustment of the inlet air temperature and/or by changing the rotation rate. This leads to significant variations in the dynamic characteristics of the plant such as response rate and time delay which cause difficulties in obtaining adequate performance over the operating range.

The article is organized as follows. In section 2, a description of the system is presented. In section 3 the model of the plant is included which proves to be a high-order nonlinear system. The control structure that is used is described in section 4. The application of PID controllers and results obtained by simulation using the non-linear model of the plant are presented in section 5. Finally the major conclusions to be drawn are given.

## 2. SYSTEM DESCRIPTION

The system considered corresponds to a *co-current rotary dryer*. The main objective of the rotary dryer is to reduce the outlet moisture of the product at a desired value by heating the product with the air passing through the dryer. A dryer plant, as shown in Fig. 1, includes in addition to the drum, many auxiliary elements needed for feeding the product and generating the necessary heat. Thus, the dynamics of elements as burners, transport bands, storage silos, pipelines, valves, filters, etc., should be considered to design the control system.

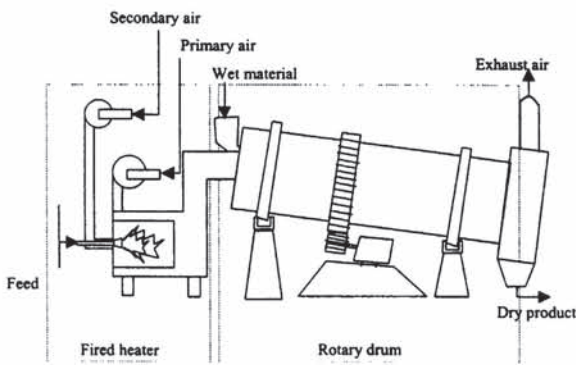

Fig. 1. Co-current rotary dryer

In a rotary dryer the wet material is continually transported by the rotation of the drum, and dropped through an hot air current that circulates throughout the dryer. The cylinder has a continuous series of blades inside, so that while turning the drying cylinder, these blades take the material and throw it in waterfall within the gaseous current. Generally, the drum turns to a speed between 3 to 4 rpm, and the speed of the air varies between 1.5 to 3.5 m/s, depending on the size of the particles to dry and on the quantity of fine powder formed during the process. The speed of rotation, angle of elevation and air velocity determine the material holdup time.

Concerning the air flow direction, it is fundamental to use the solid flow in favor of the air current when a great moisture proportion must be evaporated in the first stages of the dryer, allowing to reach high temperatures in the inlet air without reaching dangerous temperatures in the product to be dried. Since the air and solid temperatures converge while the flows reach the outlet, the temperature of the solid that leaves the cylinder can be easily controlled until it reaches its maximum value, while maintaining the advantage of having a great difference of temperatures in the first stages.

The typical control scheme for a rotary dryer, takes into account that the primary control maintains the air flow and inlet air temperature. Pressure control is also needed to maintain pressure within the dryer, and temperature and level alarms at the dry product outlet must be included. A temperature alarm is also necessary at the air outlet to prevent the dryer from overheating when feed is stopped.

## 3. THE SYSTEM MODEL

In rotary dryers, water is removed from the product by means of a hot air stream. This air transfers heat to the solid and eliminates its moisture. Heat transmission takes place mainly by conduction and convection in adiabatic conditions.

The solid particle is dried in four steps as shown in figure 2 (Liptak, 1999). First, the particle is heated up to the drying temperature, then moisture is evaporated from the wet surface and later the surface is partially dried. Finally the particle surface is completely dried through a combination of internal evaporation and diffusion.

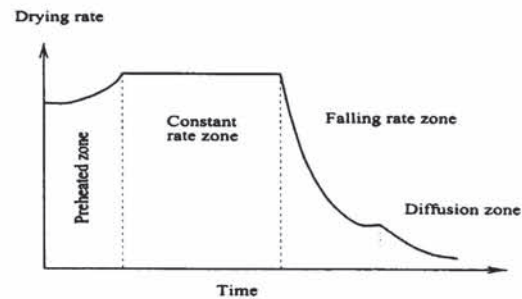

Fig. 2. Phases of the drying process

Due to drum's geometry, strong gradients of concentration and temperature appear. Therefore, the application of mass and energy balance equations gives rise to the appearance of partial derivatives differential equations, which can be avoided dividing the dryer in a finite number of elements in series; in each element balance equations are applied.

The following variables appear:

- $FS$ : mass flow of dry solid (kg/s)
- $MS$ : mass of dry solid (kg)
- $FA$ : mass flow of water in the solid (kg/s)
- $MA$ : mass of water in the solid (kg)
- $FG$ : mass flow of dry gas (kg/s)
- $MG$ : mass of dry gas (kg)
- $FH$ : mass flow of steam in the gas (kg/s)
- $MH$ : mass of steam in the gas (kg)
- $TG$ : temperature of gas stream ( $^{\circ}C$ )
- $TS$ : temperatur of solid ( $^{\circ}C$ )
- $X$ : moisture of solid in dry basis (kg water /kg dry solid)

$BH$ : moisture of solid in wet basis (kg water /kg wet solid)

$Y$ : humidity of gas in dry basis (kg water /kg dry gas)

$W$ : flow of evaporated water (kg/s)

$Cp_s$ : specific heat of solid 1.58 (kJ/kg °C)

$Cp_a$ : specific heat of water 4.18 (kJ/kg °C)

$Cp_g$ : specific heat at constant pressure of dry gas (kJ/kg °C)

$Cp_h$ : specific heat at constant pressure of water steam (kJ/kg °C)

$H$ : enthalpy of steam (kJ)

$\lambda$ : latent heat of vaporization at 0 °C (kJ/kg)

$U$ : heat transfer per volume coefficient (kW/m<sup>3</sup> °C)

$V$ : volume of each section (m<sup>3</sup>)

Balance equations come from the analysis of the flows that cross the  $i$ -th section. Supposing that the conditions in the dryer input are known, the outputs of each section  $i$  are calculated as the values in the input section  $i-1$ .

Dry solid balance ( $MS_i$  and  $FS_i$  are unknowns):

$$\frac{\partial(MS_i)}{\partial t} = FS_{i-1} - FS_i \quad (1)$$

Water balance in solid and gas (where  $MA_i$ ,  $FA_i$ ,  $MH_i$ ,  $FH_i$  and  $W_i$  are unknown):

$$\frac{\partial(MA_i)}{\partial t} = FA_{i-1} - FA_i - W_i \quad (2)$$

$$\frac{\partial(MH_i)}{\partial t} = FH_{i-1} - FH_i + W_i \quad (3)$$

Dry gas balance ( $MG_i$   $FG_i$  are introduced):

$$\frac{\partial(MG_i)}{\partial t} = FG_{i-1} - FG_i \quad (4)$$

Energy balance in solid (the overall heat transfer coefficient is known):

$$\begin{aligned} & \frac{\partial((Cp_s MS_i + Cp_a MA_i) TS_i)}{\partial t} = \\ & = (FS_{i-1} Cp_s + FA_{i-1} Cp_a) TS_{i-1} - (FS_i Cp_s \\ & + FA_i Cp_a) TS_i + UV(TG_i - TS_i) - W_i H_i \quad (5) \end{aligned}$$

Considering that the enthalpy of water that is being evaporated is:

$$H_i = Cp_a TS_i + \lambda(TS_i) = Cp_h TS_i + \lambda$$

and using the previous mass balance equations in the solid phase:

$$(Cp_s MS_i + Cp_a MA_i) \frac{\partial(TS_i)}{\partial t} =$$

$$\begin{aligned} & = (FS_i Cp_s + FA_i Cp_a) (TS_{i-1} - TS_i) + \\ & UV(TG_i - TS_i) - W_i ((Cp_h - Cp_a) TS_i + \lambda) \quad (6) \end{aligned}$$

The mass balance equation of the gas phase is obtained expanding the term:

$$\frac{\partial(Cp_g MG_i TG_i + MH_i (Cp_h TG_i + \lambda))}{\partial t}$$

and combining it with the mass balance gives:

$$\begin{aligned} & (Cp_h MH_i + Cp_g MG_i) \frac{\partial(TG_i)}{\partial t} = \\ & = (FG_{i-1} Cp_g + FH_{i-1} Cp_h) (TG_{i-1} - TG_i) \\ & - UV(TG_i - TS_i) - W_i Cp_h (TS_i - TG_i) \quad (7) \end{aligned}$$

There are also other static equations relating the unknowns among them. It is clear that:

$$X_i = \frac{FA_i}{FS_i} \quad (8)$$

$$X_i = \frac{MA_i}{MS_i} \quad (9)$$

$$Y_i = \frac{FH_i}{FG_i} \quad (10)$$

$$Y_i = \frac{MH_i}{MG_i} \quad (11)$$

The other static equations are given by the relation between the mass of dry gas and the mass of dry solid, that can be expressed as:

$$MG_i = (V - \frac{MS_i}{\rho_s}) (\frac{29.18}{29Y_i + 18}) \frac{P}{R(TG_i + 273)} \quad (12)$$

The last equation relates mass and flow of dry solid, using the concept of residence time, that is, the mean time employed by the solid to cross the drum:

$$MS_i = T_{res} FS_i \quad (13)$$

This time can be estimated through a correlation proposed by Saeman y Mitchell (A.H. Moss, 1979), that depends on length, diameter, slope, speed of rotation and a constant  $a$  depending on the feeding:

$$T_{res} = \frac{L}{a * \text{rpm} * D * \text{slope}}$$

Therefore, it can be observed that there are 13 unknown variables and 12 equations; the problem is completed with the addition of the *evaporation speed*, that was obtained from experiments, since there are no theoretical results in the case of olive cake. These experiments are described in (Arjona, 1997), where relations are obtained to give this value depending on geometric relationships and on granulometry of the material.

The dynamics of the combustion system is really fast compared to the drum's, and is governed by the following equations:

Gas balance:

$$\frac{\partial(MG)}{\partial t} = FGa - FG + F_{comb}(1-d)\eta(1-b) \quad (14)$$

Energy balance:

$$Cp_g(T \frac{\partial(MG)}{\partial t} + MG \frac{\partial T}{\partial t}) = F_{comb}Hp\eta + \quad (15)$$

$$+ FG_a(Cp_{ga} + Y_a Cp_{ha})Ta - FG(Cp_g + Y Cp_h)T$$

Relation between mass and temperature of gas:

$$MG = V \frac{2918(1+Y)}{18+29Y} \frac{P}{R(T+273)} \quad (16)$$

Humidity of gas:

$$Y = \frac{Y_a FG_a + F_{comb}b + F_{comb}c\eta(1-b)18/2}{FG} \quad (17)$$

where,

V: volume of the combustion chamber  $m^3$

Hp: calorific power of fuel (*orujillo*) (kJ/kg wet fuel)

$F_{comb}$ : fuel mass flow (kg/s)

$\eta$ : combustion performance

b: moisture in wet basis (kg water/kg wet fuel)

c: composition of hydrogen in dry basis (kg hydrogen/kg dry fuel)

d: composition of ashes in dry basis (kg ashes/kg dry fuel)

subindex *a* refers to input conditions.

#### 4. CONTROL STRATEGY

The control system is designed in such a way that the product keeps inside specifications despite of changes in the feed or external disturbances.

The process is dominated by dead-times, due to the long residence time of solids in the drum, which can give rise to unacceptable quality since the correcting actions take a long time to act. This, together with the high price of moisture sensors, makes the control strategy to rely on variables associated to the air stream, which show faster responses. In this case, product moisture at the output must be inferred from the outlet temperature and other measures.

The typical control strategy is to maintain a certain outlet temperature acting on the fuel valve. This is better implemented as cascade control (see figure 3), where the inner loop controls fuel feed to achieve a certain inlet temperature ( $T_i$ )

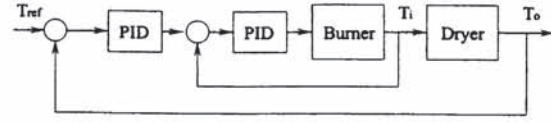

Fig. 3. Control strategy

The control of this kind of process is characterized by:

- Tight control of product moisture is not necessary. Furthermore, moisture cannot usually be measured on line.
- The inlet solid flow can be assumed to be constant once the production of the plant has been fixed.
- Moisture of feed product can vary substantially and therefore the thermal efficiency too.
- The manipulated variable is usually the temperature of combustion air coming from the burner ( $T_i$ ), that is manipulated acting on the fuel flow, while the flow of combustion air is practically constant.

In practice, the control strategy consists of a cascade structure, where the inner loop controls the inlet temperature (just after the burner) and the outer controls the outlet temperature. This choice is suitable for this process since the perturbation affects the manipulated variable.

An important fact to be considered is the fuel feed to the burner. As it is solid, there is a considerable dead-time since it enters the combustion chamber until it starts combustion. This deadtime is constant and must be taken into account to tune the inner loop of the cascade controller. As this deadtime is dominant over the time constant, the PID should be detuned to keep stability, unless another strategy is employed. In this case, a Smith predictor has been added to the formulation, giving rise to good results in the inner loop.

This control strategy, that is commonly employed in industry, does not guarantee a desired value for the outlet moisture. As only gas temperature is controlled, the solid moisture is given by the operating conditions. Therefore, if moisture is to be kept at a certain value, the gas temperature setpoint must be chosen to drive the moisture to that value. In order to achieve this, a higher-level calculation module is added that calculates the correct temperature setpoint necessary to take the moisture to its desired value (see figure 4).

The derivation of this module is difficult since the relationship between gas temperature and solid moisture is not clear. Besides, there is a lot of variables that have influence on moisture. The table 1 shows different values of operational variables that drive the outlet moisture to 0.265, with a gas flow of 8.15 kg/s.

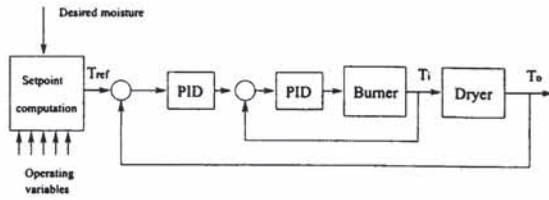

Fig. 4. Moisture inference

$T_i$ (C)	$B_{hi}$	$F_s$ (kg/s)	$Prod$ (kg/s)	$T_o$ (C)
500	0.65	0.81	2.314	119.3
	0.635	0.91	2.493	109
	0.666	0.71	2.126	132
450	0.627	0.81	2.172	114
	0.612	0.91	2.345	105
	0.643	0.71	1.989	125
550	0.67	0.81	2.454	125
	0.657	0.91	2.653	112
	0.686	0.71	2.261	138

Table 1. Combustion temperature, inlet moisture, feed flow and outlet temperature that produce 0.265 outlet moisture

A thorough study is carried out in (Holgado, 1999), where correlations are obtained for different conditions. The expression used to obtain 0.265 in outlet moisture is:

$$T_o = 119.2 + (0.35 - 0.3F_s)(T_i - 500) + (35 - 0.3T_i)(F_s - 0.81) \quad (18)$$

being  $T_i$  and  $T_o$  input and output temperatures and  $F_s$  is the feed flow. If moisture must be driven to 0.22, the equation turns to:

$$T_o = 127 + (0.29 - 0.25F_s)(T_i - 500) + (24.17 - 0.25T_i)(F_s - 0.81) \quad (19)$$

## 5. SIMULATION STUDIES

Simulation studies were carried out to assess both the capability of the model, the identification of its parameters and the performance of the control scheme. A non-linear distributed parameter model was developed so that proposed control schemes could readily be tested by digital simulation. This type of models is very useful for modeling industrial processes (E.F. Camacho and Gutierrez, 1988).

The model for the complete plant is built up as a series of elements, which can be solved via an iterative finite difference approach. The variables of the dryer are calculated at each time interval and for each element. Each segment is 1 meter long and the step length for integration is 0.5 seconds.

The simulation language Dymola *Dynamic Modeling Laboratory* (version 3.1.a.) has been used.

Dymola is an object oriented language for systems modeling. Parameters and coefficients of the non-linear equations were obtained both from manufacturer's data and from experimental data obtained from a scale plant.

Figure 5 shows open loop simulation performed with a step in the inlet gas temperature from 500 to 550 °C during 3000 s. A zoom of initial zone of the plot has been included in figure 6, showing the initial response where it can be seen how the model reproduces the behaviour of the air temperature at the end of the rotary dryer. During the first seconds, due to the high rise in the gas temperature, similar rise of the evaporation flow is produced. Later, as the temperature rises more slowly, the flow also makes it slowly.

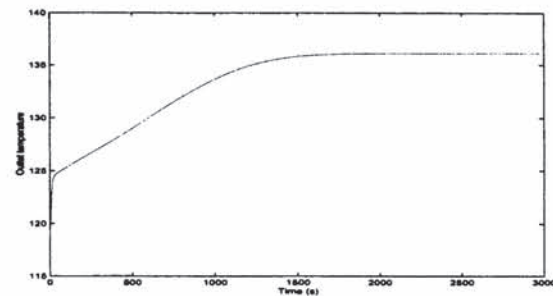

Fig. 5. Outlet temperature at one step in inlet temperature

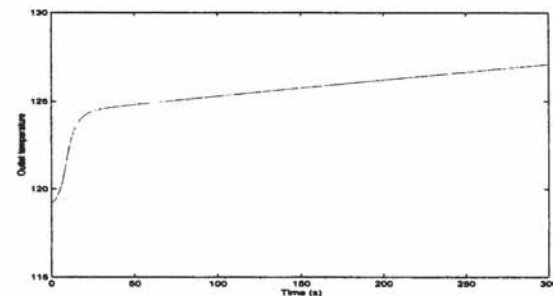

Fig. 6. Outlet temperature at one step in inlet temperature

Figure 7 shows the moisture response of the system in the same open-loop test commented previously. It can be seen how the response is related to the outlet gas temperature. As this relationship is non-linear and difficult to obtain, the inferential control is used.

The following figures show the evolution of the system output (outlet temperature) in different conditions. Figure 8 shows the behaviour of the dryer with the proposed PID controlling the outlet temperature at a constant value when faced to a step input in the inlet moisture from 0.65 to 0.68 when the moisture inference control is not used. It can be seen that it does a good job of tracking the reference signal. Figure 9 shows the effect of this disturbance on the outlet moisture that reaches a

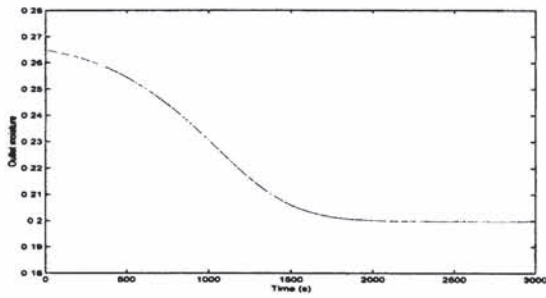

Fig. 7. Outlet moisture at one step in inlet temperature

different permanent value because the controller tries to maintain only the outlet temperature.

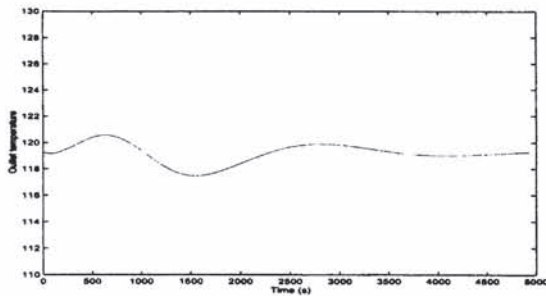

Fig. 8. Disturbance rejection in the temperature loop

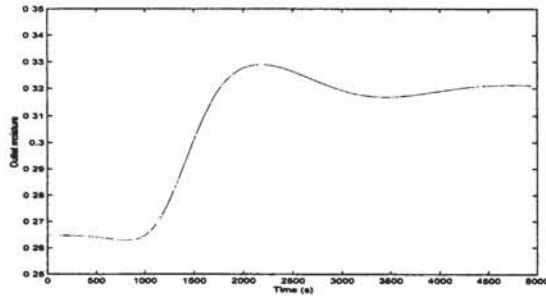

Fig. 9. Outlet moisture at one step in inlet moisture

In order to carry solid moisture to a desired value, the control scheme used is the one previously described. The estimated behaviour of moisture is simulated in figure 10. From this figure it can be observed that the response in the same situation reaches the desired value of 0.265. Note that the dynamics of this response is not controlled, but only its final value, since the inferred moisture is calculated in stationary phase. It can be observed how it is necessary to put some compensation to achieve the moisture dynamics objective. Figure 11 shows how the outlet temperature changes in order to achieve the desired moisture.

## 6. CONCLUSIONS

Applications of PID controllers to a co-current rotary dryer have been presented. The method was

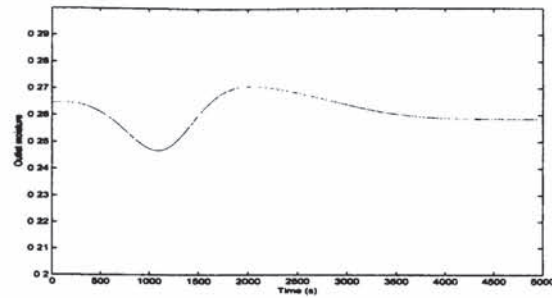

Fig. 10. Outlet moisture with a inlet moisture disturbance and inference controller

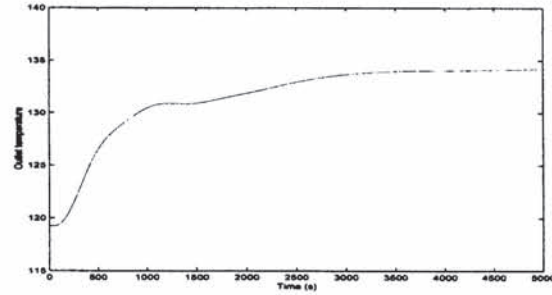

Fig. 11. Outlet temperature with inference controller

developed as a result of studies in progress for the global control of two real plants and, as the work presented shows, can readily be incorporated into a commercial control equipment. The controller is being tested by simulation and some of the results of these tests have been shown.

**Acknowledgements.** The authors would like to acknowledge Prof. Pedro Ollero for his collaboration in the modelling analysis. This work was supported by the EC under the FEDER program and by the CICYT under grants 1FD97-0735, 1FD97-0836 and TAP98-0541.

## 7. REFERENCES

- A.H. Moss, G. Nonhebel (1979). *El secado de sólidos en la industria química*. Reverte.
- Arjona, R. (1997). Análisis del proceso de secado de alpeorajo. *PFC Universidad de Sevilla*.
- E.F. Camacho, F.R. Rubio and J.A. Gutierrez (1988). Modelling and simulation of a solar power plant with a distributed collector system. *Preprints of the IFAC Symp. on Power Systems Modelling and Control Applications*.
- Holgado, J. (1999). Modelo dinámico y estrategias básicas de control para secadero rotativo de alpeorajo. *PFC Universidad de Sevilla*.
- Liptak, B.G. (1998). Optimizing dryer through better control. *Chemical Engineering*.
- Liptak, B.G. (1999). *Optimization of industrial processes*. CRC Press.
- Shinsky, F.B. (1996). *Process Control Systems*. McGraw-Hill, New York.