

Demonstration of negative refraction of microwaves

Maria C. Velazquez-Ahumada, Manuel J. Freire,^{a)} Jose M. Algarin, and Ricardo Marques
Department of Electronics and Electromagnetism, University of Seville, 41012 Seville, Spain

(Received 30 June 2010; accepted 7 December 2010)

An experimental setup to demonstrate negative refraction is described. A simple method for designing and fabricating a metamaterial with negative refractive index at microwave frequencies is discussed. The metamaterial is made of a multilayer planar arrangement of flat unit cells. A prism was fabricated and used to demonstrate negative refraction at the prism-air interface. The prism is designed for demonstrations and works at the frequency of commercial microwave transmitters and receivers. © 2011 American Association of Physics Teachers.
 [DOI: 10.1119/1.3537122]

I. INTRODUCTION

In the well-known law of refraction in optics, the angles of incidence and refraction are measured on different sides from the normal to the boundary between two ordinary isotropic media [see Fig. 1(a)]. In recent years, a new class of materials, called metamaterials,¹ have appeared which do not obey the law of refraction. Instead, at the boundary between an ordinary medium and a metamaterial, the angles of incidence and refraction can be on the same side from the normal [see Fig. 1(b)]. This phenomenon is known as negative refraction and is a property of materials for which both the relative permittivity ϵ_r and the relative permeability μ_r are both negative.² Metamaterials are composite materials with effective values of ϵ_r and μ_r determined by their structure rather than by the intrinsic properties of the material components (which are conventional conductors and dielectrics).

In this paper, an experimental setup for demonstrating negative refraction is discussed. The demonstration uses electromagnetic waves with a frequency in the microwave band. A prism of metamaterial is designed and fabricated to operate in combination with commercial microwave transmitters and receivers commonly used in physics laboratories.

II. THEORY

Metamaterials with $\epsilon_r < 0$ and $\mu_r < 0$ are also known as left-handed materials or negative refractive index materials, in contrast to ordinary materials which are right handed. The reason for labeling $\epsilon_r < 0$ and $\mu_r < 0$ media as left-handed media can be briefly explained as follows.² Consider the Maxwell equations,

$$\nabla \times \mathbf{E} = -i\omega\mu\mathbf{H}, \quad (1)$$

$$\nabla \times \mathbf{H} = i\omega\epsilon\mathbf{E}, \quad (2)$$

where $\epsilon = \epsilon_r\epsilon_0$, $\mu = \mu_r\mu_0$, and ϵ_0 and μ_0 are the dielectric permittivity and magnetic permeability in vacuum. For the plane waves $\mathbf{E} = \mathbf{E}_0 \exp(-i\mathbf{k} \cdot \mathbf{r} + i\omega t)$ and $\mathbf{H} = \mathbf{H}_0 \exp(-i\mathbf{k} \cdot \mathbf{r} + i\omega t)$, Eqs. (1) and (2) reduce to

$$\mathbf{k} \times \mathbf{E} = \omega\mu\mathbf{H}, \quad (3)$$

$$\mathbf{k} \times \mathbf{H} = -\omega\epsilon\mathbf{E}. \quad (4)$$

We see that for positive ϵ and μ , \mathbf{E} , \mathbf{H} , and \mathbf{k} form a right-handed orthogonal system of vectors [see Fig. 2(a)]. However, if $\epsilon_r < 0$ and $\mu_r < 0$, then Eqs. (3) and (4) can be rewritten as

$$\mathbf{k} \times \mathbf{E} = -\omega|\mu|\mathbf{H}, \quad (5)$$

$$\mathbf{k} \times \mathbf{H} = \omega|\epsilon|\mathbf{E}, \quad (6)$$

showing that \mathbf{E} , \mathbf{H} , and \mathbf{k} form a left-handed triplet, as illustrated in Fig. 2(b).

The main implication of this analysis is backward-wave propagation. The direction of the time-averaged flux of energy is determined by the real part of the Poynting vector,

$$\mathbf{S} = \frac{1}{2}\mathbf{E} \times \mathbf{H}^*, \quad (7)$$

which is unaffected by a simultaneous change of sign of ϵ_r and μ_r . Thus, \mathbf{E} , \mathbf{H} , and \mathbf{S} still form a right-handed triplet in a left-handed medium. In such media, the energy and wave fronts travel in opposite directions.

Now consider refraction at the interface between an ordinary and a left-handed medium. The boundary conditions require the continuity of the tangential components of the wave vector along the interface. From the backward propagation in the left-handed region it follows that, unlike in ordinary refraction, the angles of incidence and refraction must have opposite signs. This effect is illustrated in Fig. 3.

From the continuity of the tangential components of the wave vectors of the incident and refracted rays, it follows that (see Fig. 3)

$$\frac{\sin \theta_1}{\sin \theta_2} = \frac{-|\mathbf{k}_2|}{|\mathbf{k}_1|} \equiv \frac{n_2}{n_1} < 0, \quad (8)$$

which is the well-known law of refraction. In Eq. (8) n_1 and n_2 are the refractive indices of the ordinary and the left-handed medium, respectively. If $n_1 > 0$, it follows that $n_2 < 0$ from Eq. (8). That is, the sign of the square root in the refractive index definition must be negative,²

$$n \equiv -\sqrt{\epsilon_r\mu_r} < 0. \quad (9)$$

For this reason, left-handed media are also referred to as “negative refractive index” or “negative refractive” media.¹

III. METHODOLOGY AND RESULTS

A common way to demonstrate refraction is to form a prism, shine a beam through it, and observe the deflection of the beam on the other side. Waves enter the prism through one of the interfaces at normal incidence and strike the opposite interface at an oblique angle. For a prism made of ordinary or right-handed material this angle is positive [see Fig. 4(a)] and is negative for a prism of left-handed material [see Fig. 4(b)]. Negative refraction of waves in the micro-

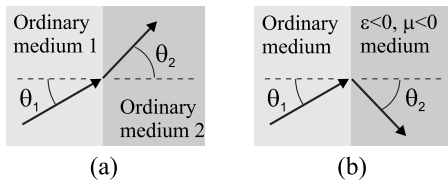

Fig. 1. Refraction at the boundary between (a) two ordinary media or right-handed media and between (b) an ordinary medium and a left-handed medium.

wave range is demonstrated in an experiment where a microwave beam is refracted through a left-handed prism of a fabricated metamaterial.

Negative refraction of microwaves was first shown experimentally by Shelby *et al.*³ for a prism consisting of a three-dimensional array of metallic wires and metallic split-ring resonators. Split-ring resonators provide a strong magnetic response and have been well studied (see, for example, Ref. 1 and references therein). Arrays of wires have also been analyzed for designing metamaterials with specific electric behavior.¹ In the metamaterial prism considered in Ref. 3 the array of wires had $\epsilon_r < 0$, in contrast to the magnetic response of the split-ring resonators which was $\mu_r < 0$.

We will fabricate a metamaterial with a simpler structure. Because the prism is illuminated by linearly polarized plane waves coming from a microwave source, it is not necessary to have an isotropic material with scalar $\epsilon_r < 0$ and $\mu_r < 0$. It is sufficient to fabricate an anisotropic material with $\epsilon_r < 0$ in the direction of the electric field \mathbf{E} and $\mu_r < 0$ in the direction of the magnetic field \mathbf{H} . A simple way to obtain $\epsilon_r < 0$ in the direction of \mathbf{E} is to pile metallic plates which are parallel to the direction of \mathbf{E} , so that each pair of closed plates constitutes a parallel plate waveguide.⁴ The propagation constant β of the fundamental transverse electric (TE_1) or the magnetic (TM_1) mode in a parallel plate waveguide is given by⁴

$$\beta = \sqrt{k_0^2 - \left(\frac{\pi}{d}\right)^2}, \quad (10)$$

where k_0 is the free-space wave number, d is the distance between the plates, and π/d is the cutoff wave number. The effective relative permittivity of this waveguide is⁴

$$\epsilon_r = \left(\frac{\beta}{k_0}\right)^2 = 1 - \left(\frac{\pi}{dk_0}\right)^2 = 1 - \left(\frac{c}{2df}\right)^2, \quad (11)$$

where f is the operating frequency, c is the speed of light in vacuum, and $c/2d$ represents the cutoff frequency. By choosing f to be less than the cutoff frequency, it is possible to obtain $\epsilon_r < 0$. To obtain $\mu_r < 0$ in the direction of the \mathbf{H} field, a two-dimensional planar array of split-ring resonators per-

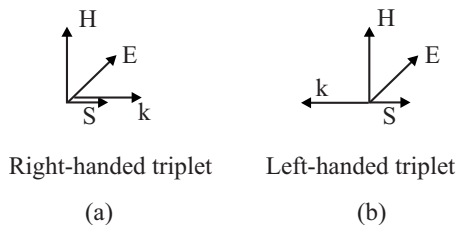

Fig. 2. Illustration of the system of vectors \mathbf{E} , \mathbf{H} , \mathbf{k} , and \mathbf{S} for a plane wave in (a) an ordinary medium and (b) a left-handed medium.

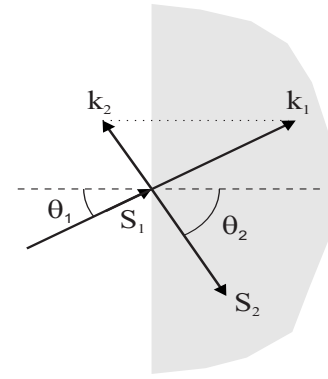

Fig. 3. Demonstration of the negative refraction between ordinary (1—white) and left-handed (2—gray) media. The Poynting and wave vectors at each media are labeled as \mathbf{S}_1 , \mathbf{S}_2 , \mathbf{k}_1 , and \mathbf{k}_2 , respectively. Negative refraction arises from the continuity of the components of the wave vectors, \mathbf{k}_1 and \mathbf{k}_2 , parallel to the interface and from the fact that rays propagate along the direction of energy flow. That is, rays must be parallel to the Poynting vectors \mathbf{S}_1 and \mathbf{S}_2 .

pendicular to the \mathbf{H} field is introduced between the plates.

The fabricated prism consists of a multilayered planar arrangement of flat unit cells as shown in Fig. 5(a). Inside each cell $\epsilon_r < 0$ in the direction of \mathbf{E} and $\mu_r < 0$ in the direction of \mathbf{H} . Figure 5(b) shows a sketch of one flat unit cell consisting of an array of split-ring resonators placed between two foam layers (Rohacell 51 HF), 6 mm of thickness, and permittivity close to unity. The two foam layers are shielded by thin metallic plates at the top and the bottom (the metal plates were made using the copper metallization of thin FR4 circuit boards). The thickness of each flat unit cell is 12 mm. The operating frequency of 10.5 GHz is fixed by the microwave transmitter and receiver used in the demonstration. For this frequency, Eq. (11) gives $\epsilon_r = -0.4$ for $d = 12$ mm.

The geometry and dimensions of the array of split-ring resonators are shown in Fig. 5(c). We have developed models for making uniform metamaterials.⁵ With the help of this model, which takes into account the resonance frequency of the split-ring resonators, dimensions, mutual couplings, and periodicity of the array, a desired magnetic response can be obtained. As a simple rule of thumb, to obtain $\mu_r < 0$ at a desired frequency, the split-ring resonator has to be designed to resonate at a frequency slightly below the operating frequency. In the device used in this paper, the resonance frequency of the fabricated split-ring resonators has an average value (due to tolerances in the photoetching process) of 10.35 GHz. Taking into account this resonance frequency

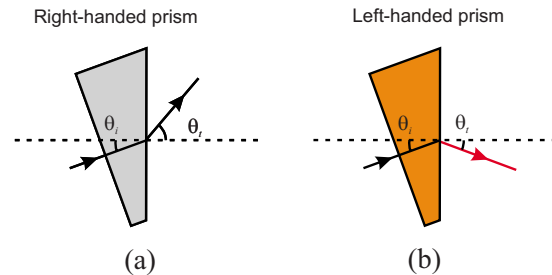

Fig. 4. Refraction through a prism. The angle of refraction is positive for a prism made of (a) an ordinary or right-handed material and (b) is negative for a prism made of left-handed material or metamaterial.

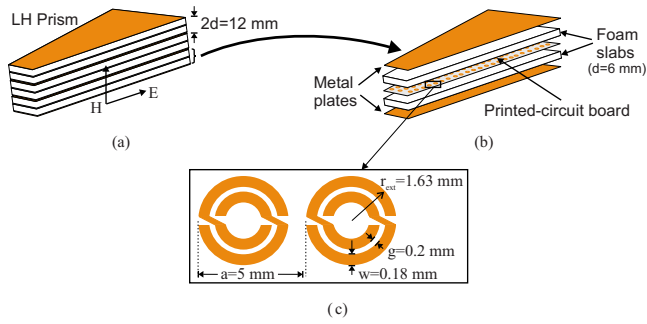

Fig. 5. (a) Multilayer structure of the fabricated prism of left-handed material. (b) Details of the structure of a layer consisting of a printed circuit board with resonant rings between a pair of foam slabs; the layer is covered by metal plates. (c) Geometrical details of the resonant rings.

and the dimensions indicated in Fig. 5(c), our model gives $\mu_r = -0.75$ at the working frequency of 10.5 GHz.⁵

The values of $\epsilon_r = -0.4$ and $\mu_r = -0.75$ give a negative index of refraction equal to -0.55 . The dimensions of the split-ring resonators were chosen with the help of freely available software.⁶ The geometry shown in Fig. 5(c) was chosen for its symmetry,⁷ which ensures a purely magnetic response, so that the effective ϵ_r provided by the metal plates is not affected by the presence of the split-ring resonators. The split-ring resonators were photoetched in an ARLON dielectric substrate LX02003311 with dielectric constant of 2.33 and dielectric thickness of 0.508 mm.

A metamaterial consisting of a multilayered structure of three unit cells was fabricated, and a 20° prism was cut from it. The prism was placed in a slot made in a polyvinyl chloride (PVC) mounting base, and the base was placed between a microwave transmitter and a receiver. Figure 6 shows a photograph of the setup. In the setup the transmitter is fixed and is normal to the output interface of the prism; the receiver can be rotated around the prism by means of a goniometer. The microwave transmitter and receiver were 10.5 GHz microwave horns (PASCO). The metamaterial was designed to work at this frequency, but it can be easily designed

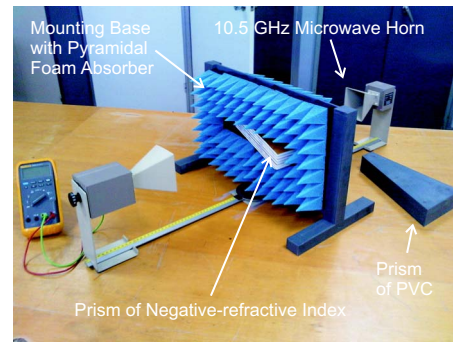

Fig. 6. Photograph of the experimental setup. A prism of left-handed material is placed in a mounting base covered with pyramidal absorbing foam. The mounting base is placed in the center of a goniometer, which allows a microwave horn receiver to rotate. A microwave horn emitter is shown on the other side. Both the emitter and the receiver are commercial horns used for physics demonstrations. The photograph also shows an ordinary prism made of PVC.

to work at other frequencies by changing the resonance frequency of the split-ring resonators and the distance between the metal plates. The receiving horn was placed on the goniometer arm at a distance from the mounting base larger than ten wavelengths ($\approx 30\text{ cm}$) to ensure that the wave at the receiving horn was approximately planar.

The PVC mounting base was covered with adhesive copper foil, and pyramidal foam absorber was placed at both sides. This foam absorber prevents the formation of standing wave patterns between the horns and the mounting base. If standing wave patterns are present, the signal in the receiver would oscillate with the position of the receiver along the goniometer arm. A second 20° PVC prism was also fabricated for comparison purposes.

Figure 7 shows the measured radiation pattern for both prisms. The measurements were obtained by rotating the receiver between 50° and -50° in steps of 5° and recording the voltage that was measured by a voltmeter connected to this receiver⁸ (see the photograph in Fig. 6). The voltage is

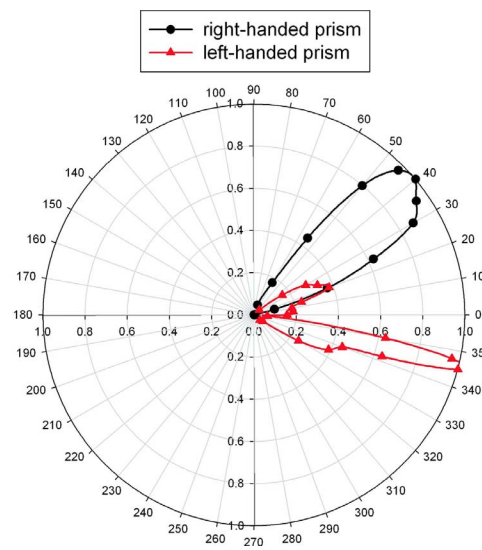
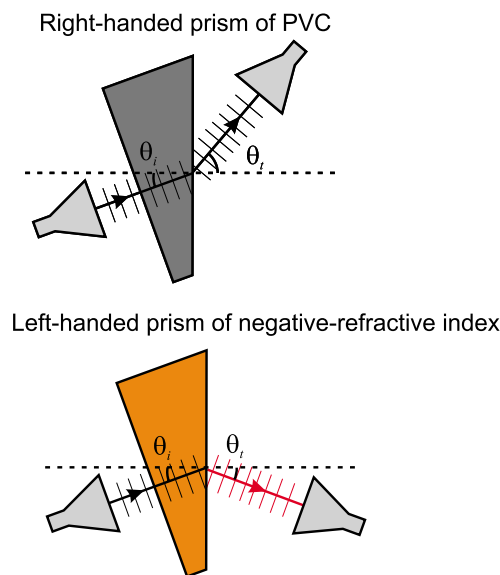

Fig. 7. Radiation pattern obtained with the setup shown in Fig. 6 for the ordinary or right-handed prism of PVC and the left-handed prism. Main lobes of radiation are obtained at 38° for the right-handed prism and at -15° for the left-handed prism.

greatly reduced by the presence of the foam absorber, but the number of layers in the metamaterial was sufficient to obtain a measurable signal (the width of the slot in the mounting base corresponds to the thickness of the multilayered structure of three flat unit cells, that is, 36 mm, which is also approximately one wavelength at 10.5 GHz). The results in Fig. 7 for the radiation pattern of the PVC prism show a main lobe of transmission for a positive angle of $\approx 40^\circ$. For an incidence angle of 20° , Eq. (8) leads to an index of refraction of $n_1=1.8$. This result is very close to the expected value based on the relative permittivity of PVC,⁹ which is close to $n \approx \sqrt{3} \approx 1.7$.

When the metamaterial prism is measured in our setup, a main lobe is obtained for a negative angle of -15° (see Fig. 7). This negative angle is close to the value predicted by the calculated negative index of refraction of -0.55 . A minor lobe is also obtained when the transmitter and the receiver are aligned, corresponding to a positive angle of 20° . This minor lobe appears just in front of the emitter and can be explained by the fact that the Ewald-Oseen extinction theorem¹⁰ is not fully satisfied in our medium due to the medium's discrete and finite nature.

The main sources of errors in the experiments include misalignment of the mounting base with respect to the goniometer arm and tolerances in the fabrication process of the split-ring resonator media and in the distance between the metallic plates. We observed a maximum misalignment of 2° in the location of the maxima, which still lets us distinguish between positive and negative refractions. These errors will vary depending on the ability of the students and the quality of the components. We used a photoetching technique with a minimum resolution of 20×10^{-6} m, which is sufficient for our purposes. We also found that the alignment of the metallic plates so that they are reasonably parallel is crucial for the

success of the experiment. We repeated our experiments inside a small anechoic chamber without significant changes in the results, which shows that the partial shielding we used is sufficient for the experiment.

ACKNOWLEDGMENTS

This work was supported by the Spanish Ministerio de Ciencia e Innovación under Project Consolider-EMET CSD2008-00066.

^{a)}Electronic mail: freire@us.es

¹R. Marques, F. Martin, and M. Sorolla, *Metamaterials with Negative Parameters: Theory and Microwave Applications* (Wiley, Hoboken, NJ, 2008).

²V. G. Veselago, "The electrodynamics of substances with simultaneously negative values of ϵ and μ ," *Sov. Phys. Usp.* **10**, 509–514 (1968).

³R. A. Shelby, D. R. Smith, and S. Schultz, "Experimental verification of a negative index of refraction," *Science* **292**, 77–79 (2001).

⁴D. M. Pozar, *Microwave Engineering* (Addison-Wesley, New York, 1993).

⁵J. D. Baena, L. Jelinek, R. Marques, and M. G. Silveirinha, "Unified homogenization theory for magnetoinductive and electromagnetic waves in split-ring metamaterials," *Phys. Rev. A* **78**, 013842 (2005).

⁶The software can be freely downloaded from james.eii.us.es/srrCalculator/.

⁷J. D. Baena, J. Bonache, F. Martn, R. Marqus, F. Falcone, T. Lopetegi, M. A. G. Laso, J. Garca-Garca, I. Gil, M. Flores-Portillo, and M. Sorolla, "Equivalent-circuit models for split-ring resonators and complementary split-ring resonators coupled to planar transmission lines," *IEEE Trans. Microwave Theory Tech.* **53**, 1451–1461 (2005).

⁸See supplementary material at <http://www.doi.org/10.1119/1.3537122> for an example of the measurement procedure.

⁹B. Riddle, J. Baker-Jarvis, and J. Krupka, "Complex permittivity measurements of common plastics over variable temperatures," *IEEE Trans. Microwave Theory Tech.* **51**, 727–733 (2003).

¹⁰M. Born and E. Wolf, *Principles of Optics*, 7th ed. (Cambridge U. P., Cambridge, 1999).