

# A SVM-3D generalized algorithm for multilevel converters

M. M. Prats, L. G. Franquelo, J. I. León, R. Portillo, E. Galván and J. M. Carrasco.

Electronic Engineering Department, University of Seville  
Camino de los descubrimientos s/n  
41092 Sevilla, SPAIN  
mangeles@gte.esi.us.es

**Abstract**— A novel three dimensional space vector algorithm of multilevel converters for compensating harmonics and homopolar component in system with neutral is presented. This generalized method provides an on-line computation of the nearest switching vectors sequence to the reference vector and calculates the on-state durations of the respective switching state vectors without involving trigonometric functions, look-up tables or coordinate system transformations which increase the computational load corresponding to the modulation of multilevel converters. The low computational cost of the proposed method is always the same and it is independent of the number of levels of the converter. The conventional 2D space vector algorithms are particular cases of the proposed generalized modulation algorithm.

The algorithm provides the switching sequence that minimizes the total harmonic distortion and the commutation number of the semiconductor devices.

## I. INTRODUCTION

Multilevel converters are becoming increasingly popular for high power applications for their ability to meet the increasing demand of power ratings and power quality associated with reduced harmonic distortion and lower EMI [1]. They present the capability of increasing the output voltage magnitude and reducing the output voltage and current harmonic content, the switching frequency and the voltage supported by each power semiconductor. Recently, several two dimensional (2D) multilevel converter modulation algorithms have been proposed [2]-[8]. In [2] and [3] SPWM techniques are proposed. However the complexity and the computational cost increase with the number of levels of the converter. Most of the presented modulation algorithms use trigonometric functions [4] or pre-computed tables [5]. The space vector algorithm proposed in [6] is the first one that calculates the switching vectors and the times without using angles, trigonometric functions or tables. In addition, the complexity and the computational cost are very low. In [7] and [8] this algorithm is improved. The 3D algorithm presented in this work is a generalization of the well known 2D space vector technique.

The replacement of conventional two level converters by multilevel converters in active filters highly improves the harmonic content of the output signal of the converter. Most of the active filter control techniques found in the bibliography are based on current control Pulse Width Modulation (PWM) or bang-bang [9][10] where each leg of the converter is independently controlled. However, it would be desirable to use an effective 3D Space Vector Modulation for this kind of applications because it can drastically reduce the control complexity and the computational load.

It is necessary to develop a new three dimensional (3D) space vector algorithm for multilevel converter for compensating homopolar component in active power filters with neutral with single-phase distorting loads which generate large neutral currents.

In general, the proposed algorithm is useful in systems with or without neutral, unbalanced load, triple harmonics and for generating whatever three-dimensional control vector.

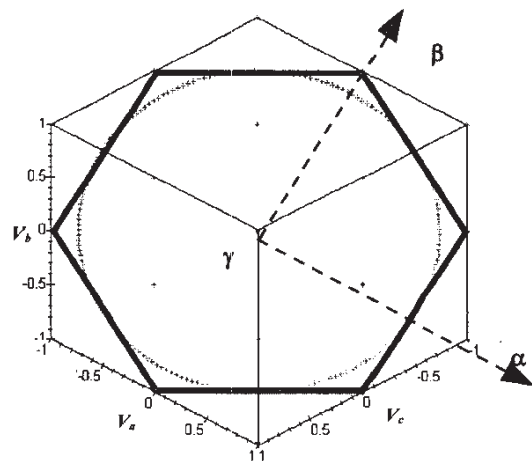

Fig. 1. 3D space vectors in a plane

The space vectors will be in a plane if the system is balanced without triple harmonics. This is shown in figure 1 and 2. However, it is necessary to generalize to a 3D

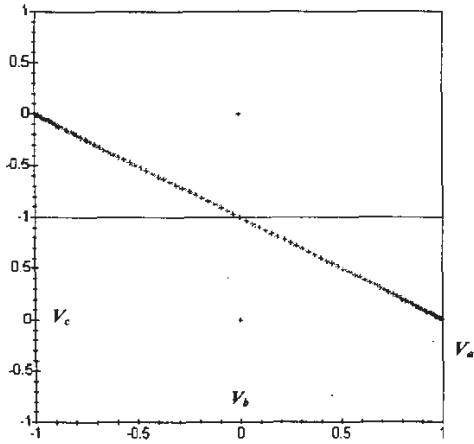

Fig. 2. Space vectors of a balanced system without triple harmonics

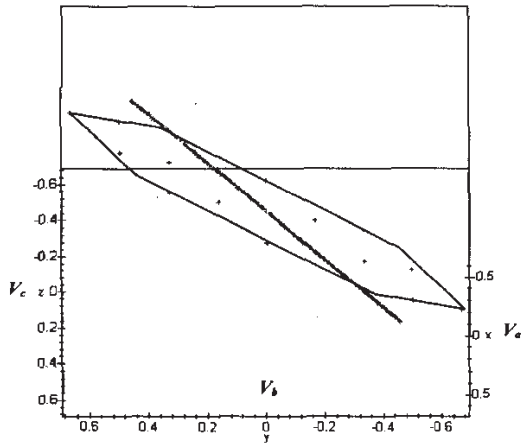

Fig. 3. System with neutral and homopolar component

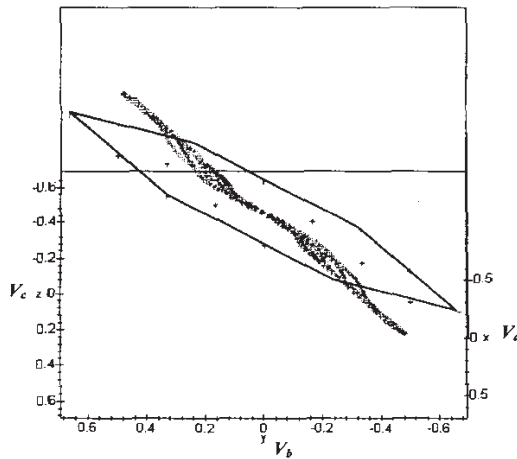

Fig. 4. Space vectors of an unbalanced system with triple harmonics

space if the system is unbalanced or if there are

homopolar component or triple harmonics because the space vectors are not in a plane as it is shown in figures 3 and 4. The reference vector has fixed amplitude and it is rotating in the complex plane.

The conventional 2-D space and the used 3D space vectors of a three-level converter are shown in the following figures.

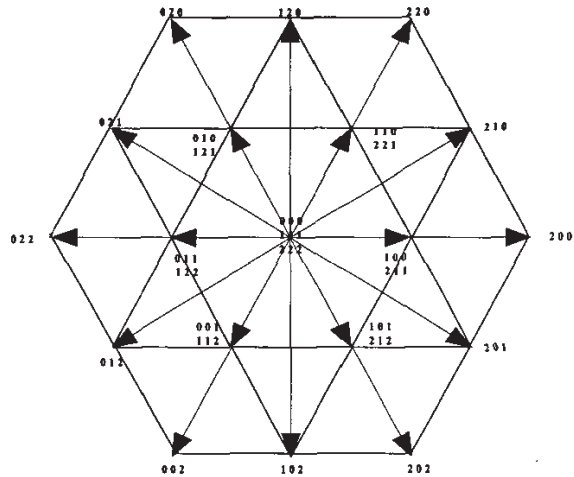

Fig. 5. 2D Space vectors of a three-level converter

The proposed algorithm is the first 3D space vector modulation technique for multilevel converters which permits the on-line calculation of the sequence of the nearest space vector for generating the reference voltage vector. In this work, a very simple and fast 3D modulation algorithm based on geometrical considerations is presented. The computational cost of the proposed method is very low and it is independent of the number of levels of the converter. This technique can be used as modulation algorithm in all applications which provide a 3D vector control. The 3D space vectors of a three-level converter is shown in figure 6.

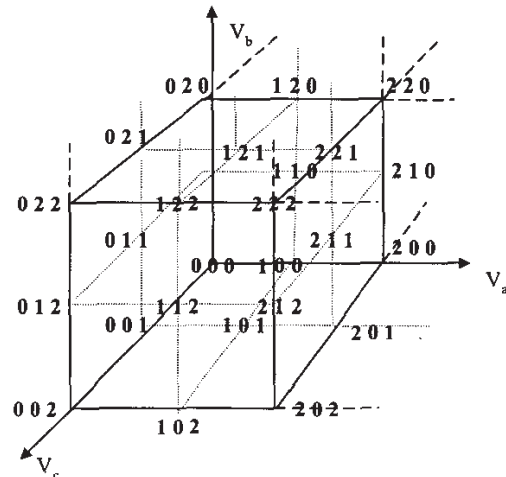

Fig. 6. 3D Space vectors of a three-level converter

## II. MODULATION TECHNIQUE DESCRIPTION

### A. Reference vector synthesis

The proposed 3D Space Vector Modulation (SVM) algorithm easily calculates the four state vectors which generate the reference vector. In general, with unbalanced systems or with triple harmonics, the reference vector could be not placed in the 2D plane of the multilevel converter. In this way, it is necessary to use a switching sequence with four state vectors. Thus, the reference vector will be pointing to a volume which is a tetrahedron. The vertexes of that tetrahedron are the state vectors of the switching sequence. In addition, the algorithm permits to obtain the corresponding duty cycles without using precalculated tables or trigonometric functions. The modulation algorithm input is the normalized voltage vector. The normalization only depends on the number of levels of the multilevel converter and the voltage level value of the DC-link capacitors [3].

*Step 1:* Find the sub-cube where the reference vector is pointing to.

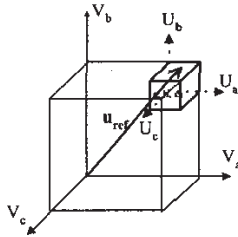

Fig. 7. Origin of the sub-cube where the reference vector is supposed to be found.

The space vectors of a multilevel converter form a cube in a 3D space. This space can be decomposed into several tetrahedrons which generate the cube total volume. For a certain reference vector in three-phase coordinates ( $u_a, u_b, u_c$ ), the integer part of each component ( $a, b, c$ ) is calculated, where:

$$\begin{aligned} a &= \text{integer}(u_a), \\ b &= \text{integer}(u_b), \\ c &= \text{integer}(u_c). \end{aligned} \quad (1)$$

The 3D space is formed by a certain number of sub-cubes depending on the number of the levels of the converter. ( $a, b, c$ ) are the origin coordinates corresponding to the reference system of the sub-cube where the reference vector is pointing to. This is shown in figure 7.

*Step 2:* There are six tetrahedrons into each sub-cube. Therefore, it is necessary to define the tetrahedron where the reference vector is pointing to. This tetrahedron is easily found using comparisons with three planes into the 3D space which define the six tetrahedrons inside the sub-cube. The three planes which define the six tetrahedrons

are shown in figure 8. Only a maximum of three comparisons are needed.

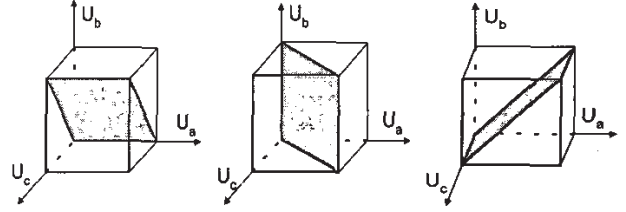

Fig. 8. Planes used for calculating the tetrahedron where the reference vector is pointing to.

*Step 3:* Once ( $a, b, c$ ) coordinates are known, the main step of the algorithm consists in calculating the four space vectors corresponding to the four vertices of a tetrahedron into a sub-cube. These vectors will generate the reference vector. Configurations of the 3D space with different number of tetrahedrons into the cube have been studied. However, the minimum number of comparisons are obtained using the six tetrahedrons showed in figure 9.

*Step 4:* Calculation of the switching times.

The new algorithm calculates on-line the four state vectors into the 3D space and the corresponding duty-cycles using only fifty eight instructions and a maximum of three comparisons for calculating the suitable tetrahedron. The computational load is always the same and it is independent of the number of levels of the multilevel converter.

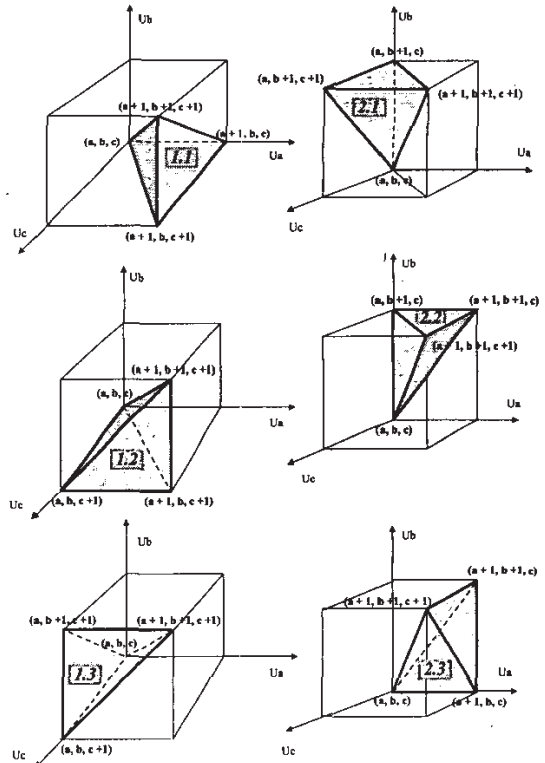

Fig. 9. Tetrahedrons into the cube with the corresponding state vectors.

## B. General structure of the algorithm

The flow diagram of the new 3D modulation algorithm for choosing the tetrahedron where the reference vector is pointing to is shown in Figure 10.

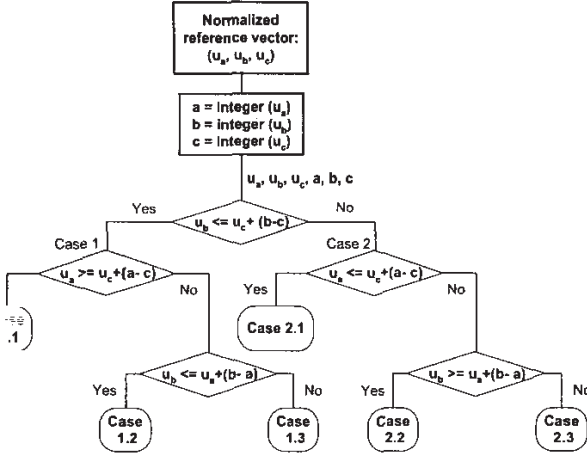

Fig. 10. 3-D algorithm for the selection of each tetrahedron with the corresponding state vectors.

Notice that the algorithm is extremely simple

## C. Calculation of duty-cycles

Once the state vectors which generate each reference vector are known, the corresponding duty-cycles are calculated. The algorithm generates a matrix with four state vectors and the corresponding switching times.

$$S = \begin{bmatrix} S^1_a & S^1_b & S^1_c & d_1 \\ S^2_a & S^2_b & S^2_c & d_2 \\ S^3_a & S^3_b & S^3_c & d_3 \\ S^4_a & S^4_b & S^4_c & d_4 \end{bmatrix} \quad (2)$$

$$t_i = d_i T_m$$

Where  $T_m$  is the sample time.

The state vectors are the vertexes of the corresponding tetrahedron which generates the reference vector. The equations to be solved are the following:

$$\begin{aligned} u_a &= S^1_a d_1 + S^2_a d_2 + S^3_a d_3 + S^4_a d_4 \\ u_b &= S^1_b d_1 + S^2_b d_2 + S^3_b d_3 + S^4_b d_4 \\ u_c &= S^1_c d_1 + S^2_c d_2 + S^3_c d_3 + S^4_c d_4 \end{aligned} \quad (3)$$

$$d_1 + d_2 + d_3 + d_4 = 1.$$

The numeric evaluation of the duty cycles or on-state durations of the switching states are reduced to a simple addition as it is shown in Table I.  $E_a$ ,  $E_b$  and  $E_c$  represent the different voltage levels of the capacitors battery. They take values between zero and  $n-1$  where  $n$  is the number of levels of the multilevel converter.

TABLE I  
STATES SEQUENCE AND SWITCHING TIMES

Tetrahedron	Space vectors sequence	Switching times
Case 1.1	$(S^1_a, S^1_b, S^1_c) = (E_a, E_b, E_c)$ $(S^2_a, S^2_b, S^2_c) = (E_a + 1, E_b, E_c)$ $(S^3_a, S^3_b, S^3_c) = (E_a + 1, E_b, E_c + 1)$ $(S^4_a, S^4_b, S^4_c) = (E_a + 1, E_b + 1, E_c + 1)$	$d_1 = 1 + a - u_a$ $d_2 = -a + c + u_a - u_c$ $d_3 = b - c - u_b + u_c$ $d_4 = -b + u_b$
Case 1.2	$(S^1_a, S^1_b, S^1_c) = (E_a, E_b, E_c)$ $(S^2_a, S^2_b, S^2_c) = (E_a, E_b, E_c + 1)$ $(S^3_a, S^3_b, S^3_c) = (E_a + 1, E_b, E_c + 1)$ $(S^4_a, S^4_b, S^4_c) = (E_a + 1, E_b + 1, E_c + 1)$	$d_1 = 1 + c - u_c$ $d_2 = a - c - u_a + u_c$ $d_3 = -a + b + u_a - u_b$ $d_4 = -b + u_b$
Case 1.3	$(S^1_a, S^1_b, S^1_c) = (E_a, E_b, E_c)$ $(S^2_a, S^2_b, S^2_c) = (E_a, E_b, E_c + 1)$ $(S^3_a, S^3_b, S^3_c) = (E_a, E_b + 1, E_c + 1)$ $(S^4_a, S^4_b, S^4_c) = (E_a + 1, E_b + 1, E_c + 1)$	$d_1 = 1 + c - u_c$ $d_2 = b - c - u_b + u_c$ $d_3 = a - b - u_a + u_b$ $d_4 = -a + u_a$
Case 2.1	$(S^1_a, S^1_b, S^1_c) = (E_a, E_b, E_c)$ $(S^2_a, S^2_b, S^2_c) = (E_a, E_b + 1, E_c)$ $(S^3_a, S^3_b, S^3_c) = (E_a, E_b + 1, E_c + 1)$ $(S^4_a, S^4_b, S^4_c) = (E_a + 1, E_b + 1, E_c + 1)$	$d_1 = 1 + b - u_b$ $d_2 = -b + c + u_b - u_c$ $d_3 = a - c - u_a + u_c$ $d_4 = -a + u_a$
Case 2.2	$(S^1_a, S^1_b, S^1_c) = (E_a, E_b, E_c)$ $(S^2_a, S^2_b, S^2_c) = (E_a, E_b + 1, E_c)$ $(S^3_a, S^3_b, S^3_c) = (E_a + 1, E_b + 1, E_c)$ $(S^4_a, S^4_b, S^4_c) = (E_a + 1, E_b + 1, E_c + 1)$	$d_1 = 1 + b - u_b$ $d_2 = a - b - u_a + u_b$ $d_3 = -a + c + u_a - u_c$ $d_4 = -c + u_c$
Case 2.3	$(S^1_a, S^1_b, S^1_c) = (E_a, E_b, E_c)$ $(S^2_a, S^2_b, S^2_c) = (E_a + 1, E_b, E_c)$ $(S^3_a, S^3_b, S^3_c) = (E_a + 1, E_b + 1, E_c)$ $(S^4_a, S^4_b, S^4_c) = (E_a + 1, E_b + 1, E_c + 1)$	$d_1 = 1 + a - u_a$ $d_2 = -a + b + u_a - u_b$ $d_3 = -b + c + u_b - u_c$ $d_4 = -c + u_c$

The duty cycles are only functions of the reference vector components and the integer part of reference vector coordinates.

In addition, the optimized switching sequence is selected in order to minimize the switching number. The space vectors sequence in half cycle are:  $(S^1_a, S^1_b, S^1_c)$ ,  $(S^2_a, S^2_b, S^2_c)$ ,  $(S^3_a, S^3_b, S^3_c)$  and  $(S^4_a, S^4_b, S^4_c)$ . In the second half cycle the space vectors is the reverse sequence.

## II. EXPERIMENTAL RESULTS

The proposed 3D technique is the generalization of the 2D

space vector algorithms. It must be noticed the behavior of a balanced system without triple harmonics using the 3D algorithm. In this case, one of the four active vectors given by the algorithm has the switching time equal to zero. Then, the problem is reduced to a 2D situation.

In the following figures the results of a modulation with triple harmonics and homopolar component are shown. In figure 11 the reference voltage signal is shown. This reference has 33% of triple harmonic of the fundamental harmonic. In figure 12, the experimental measure of phase-phase voltage is shown. The experimental measure of phase-neutral voltage is shown in figure 13.

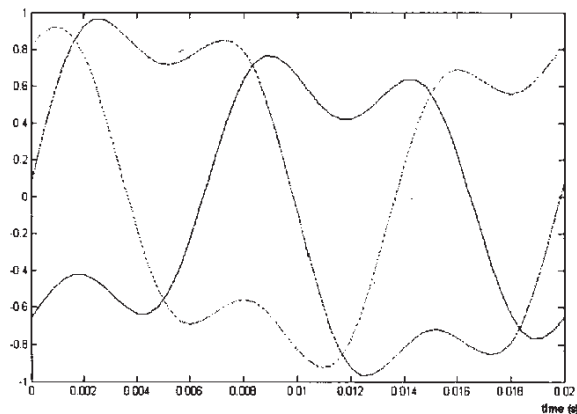

Fig. 11. Reference voltage signals with triple harmonics and homopolar component

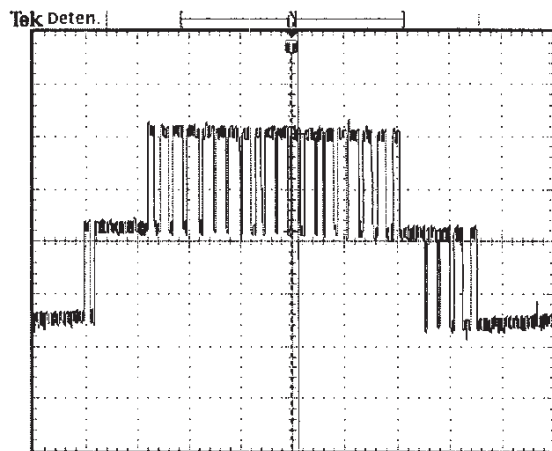

Fig. 13. Experimental phase – neutral voltage of a four wire Diode Clamped three-level converter.

The algorithm has been successfully implemented with a micro controller. The modulation output signal of  $V_a$  is shown in figure 14. This modulation is the output signal of the micro controller and it has been digitally filtered with a low pass filter that eliminates the higher frequencies. In this way, this permits to obtain the output signals of Diode Clamped Inverter ( $V_a$ ,  $V_b$  and  $V_c$ ). Clearly, the obtained signals follow the input reference signals.

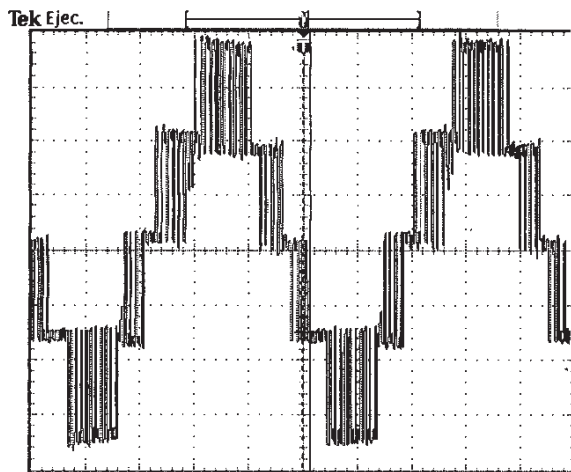

Fig. 12. Experimental phase – phase voltage of a four wire Diode Clamped three-level converter.

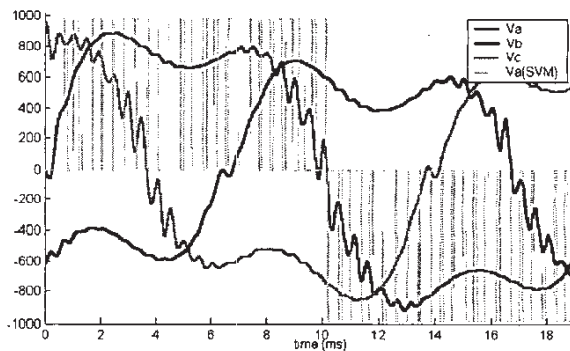

Fig. 14. Experimental results using SVM-3D in a four wire Diode Clamped three-level converter with the reference voltage signals showed in figure 11.

#### IV. CONCLUSIONS

The 3D space vector modulation algorithm presented in this work is very useful to readily calculate the switching sequence and the on-state durations of the respective switching state vectors corresponding to the space vector modulation used in multilevel converters. The proposed technique directly allows

compensating homopolar component in systems with neutral and optimizing the switching sequence minimizing the number of switching. The computational complexity is very low and independent on the number of levels of the converter. This algorithm does not use trigonometric functions or look-up tables. It has been satisfactorily implemented in very low-cost micro controllers. This technique can be used as modulation algorithm in all applications needing a 3D control vector such as active filters with four wires with single-phase distorting loads which generate large neutral currents, where the conventional two dimensional space vector modulation can not be used.

#### V. REFERENCES

- [1] A. Nabae, I. Takahashi, H. Akagy, "A Neutral-Point Clamped PWM Inverter", *Proc. IEEE Transactions on Industrial Applications*, Vol. 1A-17, No. 5, pp. 518-523, 1981.
- [2] Carrara, S.Gardella, M. Marchesoni, R. Salutati, G. Sciotto, "A New Multilevel PWM Method: A Theoretical Analysis", *Proc. IEEE Transactions on Power Electronics*, Vol.7, pp. 497-505, 1992.
- [3] Leon M. Tolbert and Thomas G. Habetler, "Novel Multilevel Inverter Carrier-Based PWM Method", *Proc. IEEE Transactions on Industry Applications*, Vol. 35, No. 5, pp. 1098 – 1107, 1999.
- [4] O. Alonso, L. Marroyo, P. Sanchis, "A Generalized Methodology to Calculate Switching Times and Regions in SVPWM Modulation of Multilevel Converters", *Proc. 10th European Conference on Power Electronics and Applications, EPE'2001*, 2001:
- [5] N. Celanovic and D. Boroyevich, "A Fast Space-Vector Modulation Algorithm for Multilevel Three-Phase Converters", *Proc. IEEE Transactions on Industry Applications*, Vol. 37, No. 2, pp. 637-641, 2001.
- [6] M.M.Prats, J.M. Carrasco, L.G. Franquelo, "Effective Algorithm for Multilevel Converter with very low computational cost", *Proc. Electronics Letters*, Vol. 38, No.22, pp.1398-1400, 2002.
- [7] M.M. Prats, R. Portillo, J.M. Carrasco and L.G. Franquelo, "New Fast Space-Vector Modulation for Multilevel Converters Based on Geometrical Considerations", *Proc. 28th Annual Conference of the IEEE Industrial Electronics Society, IECON'02*, Sevilla, España, 2002.
- [8] M.M. Prats, J.I. León, R. Portillo, J.M. Carrasco and L.G. Franquelo, "A novel space-vector algorithm for multilevel converters based on geometrical considerations using a new sequence control technique", accepted for publication in *Circuits, Systems and Computers, International Journal*, 2003.
- [9] Simone Buso, Luigi Malesani, Paolo Mattavelli, "Comparison of Current Control Techniques for Active Filter Applications", *Proc. IEEE Transactions on Industrial Electronics*, Vol. 45, No. 5, pp. 722-729, 1998.
- [10] Marian P. Kazmierkowski, Luigi Malesani, "Current Control Techniques for Three- Phase Voltage-Source PWM Converters: A Survey", *Proc. IEEE Transactions on Industrial Electronics*, Vol. 45, No. 5, pp. 691-703, 1998.