



Depósito de investigación de la Universidad de Sevilla

<https://idus.us.es/>

Esta es la versión aceptada del artículo publicado en:

This is a accepted manuscript of a paper published in:

D. Limon, A. Ferramosca, I. Alvarado and T. Alamo, "Nonlinear MPC for Tracking Piece-Wise Constant Reference Signals," in **IEEE Transactions on Automatic Control**, vol. 63, no. 11, pp. 3735-3750, **Nov. 2018**, doi: 10.1109/TAC.2018.2798803.

DOI: [https://dx.doi.org/ 10.1109/TAC.2018.2798803](https://dx.doi.org/10.1109/TAC.2018.2798803)

Copyright: © 2018 IEEE

El acceso a la versión publicada del artículo puede requerir la suscripción de la revista.

Access to the published version may require subscription.

“© 2018 IEEE. Personal use of this material is permitted. Permission from IEEE must be obtained for all other uses, in any current or future media, including reprinting/republishing this material for advertising or promotional purposes, creating new collective works, for resale or redistribution to servers or lists, or reuse of any copyrighted component of this work in other Works”

Nonlinear MPC for tracking piece-wise constant reference signals

D. Limon, A. Ferramosca, I. Alvarado, T. Alamo

Abstract—This paper presents a novel tracking predictive controller for constrained nonlinear systems capable to deal with sudden and large variations of a piece-wise constant setpoint signal. The uncertain nature of the setpoint may lead to stability and feasibility issues if a regulation predictive controller based on the stabilizing terminal constraint is used. The tracking model predictive controller presented in this paper extends the MPC for tracking for constrained linear systems to the more complex case of constrained nonlinear systems. The key idea is the addition of an artificial reference as new decision variable. The considered cost function penalizes the deviation of the predicted trajectory with respect to the artificial reference as well as the distance between the artificial reference and the setpoint. Closed-loop stability and recursive feasibility for any setpoint is guaranteed thanks to an appropriate terminal cost and extended stabilizing terminal constraint. Also, two simplified formulations are shown: the design based on a terminal equality constraint and the design without terminal constraint. The resulting controller ensures recursive feasibility for any changing setpoint. In the case of unreachable setpoints, asymptotic stability of the optimal reachable setpoint is also proved. The properties of the controller have been tested on a constrained CSTR simulation model and have been experimentally validated on a four-tanks plant.

Index Terms—Model predictive control, nonlinear systems, setpoint tracking.

I. INTRODUCTION

Model predictive control (MPC) is one of the most successful advanced control techniques in the process industry. Its properties have been widely investigated in the last two decades and currently the MPC is a control technique capable to provide stability, robustness, constraint satisfaction and tractable computation for linear and for nonlinear systems [6], [30].

Most of the stabilizing predictive controllers deal with the regulation problem, that is, controlling the system to a fixed setpoint (which is typically assumed to be the origin) [30, p.159]. Asymptotic stability of the setpoint and constraints satisfaction of the closed loop can be guaranteed by designing

The authors acknowledge MEyC Spain (contracts DPI2013-48243-C2-2-R and DPI2016-76493-C3-1-R) and the Argentinean Agency of Scientific and Technological Development, ANPCyT (under the FONCyT Grant PICT-2016-0283) for funding this work.

D. Limon, I. Alvarado, and T. Alamo are with the Departamento de Ingeniería de Sistemas y Automática, Universidad de Sevilla, Escuela Técnica Superior de Ingeniería, Camino de los Descubrimientos s/n. 41092 Sevilla, Spain. *E-mail*: {dlm, ialvarado, talamo}@us.es

A. Ferramosca is with CONICET - Universidad Tecnológica Nacional (UTN). Facultad Regional de Reconquista. Calle 27 de Abril, 1000 (3560), Reconquista, Santa Fe, Argentina. *E-mail*: ferramosca@santafe-conicet.gov.ar

The corresponding author would like to thank David Muñoz de la Peña for interesting discussions on the results of this paper and his support. The authors also would like to thank Filiberto Fele for his help with the simulations of example V.B.

the terminal cost function and the terminal constraint in such a way that they satisfy certain conditions in a neighborhood of the setpoint [27], [25], [28].

It is not unusual that this setpoint is changed during the operation of the system leading to a piece-wise constant reference signal. In the process industry the main goal of advanced control strategies is to operate the plants as close as possible to the economically optimal operation point, while ensuring the satisfaction of the operation limits and stability.

The economic objective to be optimized by the real time optimizer (RTO) may be changed during the operation of a plant, due to possible changes in the unitary costs that defines this function, adaptation of the forecasted demands or changes in disturbance estimation derived from the reconciliated data of the plant. If the economic objective changes, the economically optimal operation point may change. The stabilizing design of the MPC may not be valid at the new setpoint, and then, the feasibility of the controller may be lost. Consequently, the controller may fail to track the desired setpoint [31], [4], [29], [1], [12], [19].

Several solutions have been proposed to deal with changing setpoints [28]. In [15] a nonlinear predictive control for a finite set of setpoints is presented. This controller considers a pseudolinearization of the system and a parameterization of the setpoints. The stability is ensured thanks to a quasi-infinite nonlinear MPC strategy but only for the finite set of setpoints. If the new setpoint does not belong to the set of pre-defined setpoints, the stability may be lost.

In [9] the tracking problem for constrained linear systems is solved by means of an approach called dual mode: the dual mode controller operates as a regulator in a neighborhood of the desired equilibrium wherein constraints are feasible, while it switches to a feasibility recovery mode, whenever this is lost due to a setpoint change. This control law ensures the recursive feasibility in case of changing setpoints for linear systems. However, it may exhibit poor performance when the feasibility recovery mode is active.

In [25] an output feedback receding horizon control algorithm for nonlinear discrete-time systems is presented. This controller solves the problem of tracking exogenous signals and asymptotically rejecting disturbances generated by an exo-system. In [26] an MPC algorithm for nonlinear systems is proposed, which guarantees local stability and asymptotic tracking of constant references. This algorithm needs the addition of an integrator to the system to guarantee the solution of the asymptotic tracking problem. These predictive controllers address the tracking problem but the issue of the feasibility loss under changing setpoints is not considered.

Another approach to the tracking problem for nonlinear

systems is the so-called reference governors [2], [4], [17], [8], [16]. This solution is based on a two-layer control law such that in the lower level an unconstrained stabilizing control law is designed and in the upper level the reference governor manipulates the reference of the lower lever controller. The Reference Governor is a nonlinear feedback system which computes at each sampling time an artificial reference to ensure the admissible evolution of the system, converging to the desired reference. This class of control techniques maintains the feasibility of the problem under changing setpoints, but the fact that only one action is available, for satisfying all future constraints may lead to a poor closed-loop performance.

A novel tracking MPC formulation for constrained linear systems has been presented in [21], [14], [19]. The main characteristics of this control technique are: similarly to the reference governors, an artificial reference is considered as a new decision variable together with the sequence of future control inputs; a cost function that penalizes the predicted tracking error with respect to the artificial steady state plus an additional term that penalizes the deviation between the artificial setpoint and the (actual) setpoint (the so-called *offset cost function*) is minimized and an extended terminal constraint based on an invariant set for tracking is considered. This controller ensures that under any change of the setpoint, the closed-loop system maintains the feasibility of the controller and ensures the convergence to the setpoint if admissible.

The objective of this paper is to extend this tracking control technique to the case of nonlinear constrained systems. Some preliminary results were presented in [22], [13]. Based on these results [10] extends the idea of using a generalized terminal constraint to the context of economic predictive control of constrained nonlinear systems. The proposed controller achieves practical stability by the addition of an additional time-varying terminal constraint and by weighting the economic cost function of the terminal state. On the other hand, in [11] a time-varying constraint on the optimal cost function is added in the optimization problem and a filter on the reference provided to the predictive controller is considered in order to achieve soft transients under large changes of the setpoint.

In the present work, the ideas of [21], [14], [22], [13] have been extended to deal with constrained nonlinear systems by means of a terminal inequality constraint and a prediction horizon larger than the control horizon. Stabilizing design conditions are given and constraint satisfaction and Lyapunov stability under (potentially) piece-wise constant setpoints are rigorously proved. A simplified formulation based on a terminal equality constraint is also presented. On the other hand, the design of stabilizing MPC controllers without using a terminal constraint is particularly interesting from a practical point of view (see [28] and the references therein). In this paper, the stabilizing design in case of removing the terminal constraint is studied and novel results on this topic are derived. The proposed controller has been proved on a simple simulation case and experimentally tested on a real plant, in order to demonstrate its properties.

The paper is organized as follows. In section II the constrained tracking problem is stated. In section III the new MPC for tracking is presented. In section IV the properties of the

proposed controller are discussed in section IV-D. In section V some illustrative examples are proposed and in section VI an application on a real plant is presented. Finally, in section VII some conclusions are drawn.

Notation

A function $\alpha : \mathbb{R}_+ \rightarrow \mathbb{R}_+$ is a \mathcal{K} -function if it is continuous, strictly increasing and $\alpha(0) = 0$. A function $\beta : \mathbb{R}_+ \rightarrow \mathbb{R}_+$ is a \mathcal{K}_∞ -function if it is a \mathcal{K} -function and it is not bounded above. The inverse of the \mathcal{K} -function α is denoted as α^{-1} and is defined as $\alpha^{-1}(s) = \{t : \alpha(t) = s\}$. Given two \mathcal{K} -functions α_1 and α_2 , $\alpha_1 \circ \alpha_2(s)$ denotes the function $\alpha_1(\alpha_2(s))$. Given two sets $\mathcal{A}, \mathcal{B} \subseteq \mathbb{R}^n$, the Minkowsky sum $\mathcal{A} \oplus \mathcal{B}$ is defined as $\{c = a + b : a \in \mathcal{A}, b \in \mathcal{B}\}$ and the Pontryagin difference $\mathcal{A} \ominus \mathcal{B}$ is defined as $\{c : c \oplus \mathcal{B} \subseteq \mathcal{A}\}$. $I_n \in \mathbb{R}^{n \times n}$ denotes the identity matrix. A bold variable \mathbf{u} denotes a sequence of values of a signal $(u(0), u(1), \dots, u(N-1))$, where $u(i)$ denotes the i -th component and N is the length of the sequence. For a given $z \in \mathbb{R}^n$, $|z|$ denotes its euclidean norm. The ball of radius ε , $\mathcal{B}_n(\varepsilon) \subseteq \mathbb{R}^n$, is given by $\mathcal{B}_n(\varepsilon) = \{x \in \mathbb{R}^n : |x| \leq \varepsilon\}$.

II. PROBLEM STATEMENT

Consider a system described by a nonlinear invariant discrete time model

$$\begin{aligned} x^+ &= f(x, u) \\ y &= h(x, u) \end{aligned} \quad (1)$$

where $x \in \mathbb{R}^n$ is the system state, $u \in \mathbb{R}^m$ is the current control vector and x^+ is the successor state. The variable $y \in \mathbb{R}^p$ is the controlled output and it is chosen to define the desired equilibrium point of the plant by means of a suitable setpoint y_t .

The functions of the model $f(x, u)$ and $h(x, u)$ are assumed to be continuous at any equilibrium point. The solution of this system for a given sequence of control inputs \mathbf{u} and initial state x is denoted as $x(j) = \phi(j; x, \mathbf{u})$ where $x = \phi(0; x, \mathbf{u})$. The state of the system and the control input applied at sampling time k are denoted as $x(k)$ and $u(k)$ respectively.

The system is subject to hard constraints on state and control:

$$(x(k), u(k)) \in \mathcal{Z} \quad (2)$$

for all $k \geq 0$, where $\mathcal{Z} \subset \mathbb{R}^{n+m}$ is a closed set whose interior is not empty.

The steady state, input and output of the plant (x_s, u_s, y_s) are such that (1) is fulfilled, i.e.

$$x_s = f(x_s, u_s) \quad (3a)$$

$$y_s = h(x_s, u_s). \quad (3b)$$

In order to avoid those equilibrium points with active constraints, (for reasons that will be clear later on), the following restricted constraint set is defined

$$\hat{\mathcal{Z}} = \{z : z + e \in \mathcal{Z}, \forall |e| \leq \varepsilon\} \quad (4)$$

where $\varepsilon > 0$ is an arbitrarily small constant. Then, the set of admissible equilibrium states such that the constraints are not active is defined as follows

$$\mathcal{Z}_s = \{(x, u) \in \tilde{\mathcal{Z}} : x = f(x, u)\}, \quad (5)$$

$$\mathcal{Y}_s = \{y = h(x, u) : (x, u) \in \mathcal{Z}_s\}. \quad (6)$$

It is assumed that the set \mathcal{Z}_s is non-empty. Notice that since the parameter ε can be chosen arbitrarily small, equilibrium points arbitrarily close to the boundary of \mathcal{Z} , are contained in \mathcal{Z}_s .

Assumption 1: It is assumed that the output of the system is chosen in such a way that the steady output y_s univocally defines the equilibrium point (x_s, u_s) . That is, for any given y_s , there exists a unique steady state and input (x_s, u_s) such that $x_s = f(x_s, u_s)$ and $y_s = h(x_s, u_s)$.

It is also assumed that there exists a locally Lipschitz continuous function $g_x : \mathcal{Y}_s \rightarrow \mathbb{R}^n$ and a continuous function $g_u : \mathcal{Y}_s \rightarrow \mathbb{R}^m$ such that

$$x_s = g_x(y_s), \quad u_s = g_u(y_s). \quad (7)$$

Remark 1: Assumption 1 is satisfied if the model functions, $f(\cdot, \cdot)$ and $h(\cdot, \cdot)$, are continuously differentiable and the Jacobian matrix

$$\begin{bmatrix} (A(x_s, u_s) - I_n) & B(x_s, u_s) \\ C(x_s, u_s) & D(x_s, u_s) \end{bmatrix},$$

where

$$\begin{aligned} A(x_s, u_s) &= \frac{\partial f(x, u)}{\partial x}(x_s, u_s), & B(x_s, u_s) &= \frac{\partial f(x, u)}{\partial u}(x_s, u_s), \\ C(x_s, u_s) &= \frac{\partial h(x, u)}{\partial x}(x_s, u_s), & D(x_s, u_s) &= \frac{\partial h(x, u)}{\partial u}(x_s, u_s), \end{aligned}$$

is non-singular for all $(x_s, u_s) \in \mathcal{Z}_s$.

This is a direct consequence of the application of the implicit function theorem [7, Chapter 3] to the equilibrium point equations (3). Notice that, for the linear case, this condition is the same as the necessary and sufficient condition presented in [30, Lemma 1.14].

The objective of the paper is to design a state feedback tracking MPC control law $u = \kappa_{MPC}(x, y_t)$ such that for a given reference (setpoint or output target) y_t , the closed-loop system is stable, fulfills the constraints throughout the time and converges (as close as possible) to the equilibrium point defined by the given setpoint y_t . Besides, this property must hold even in case that the setpoint y_t is suddenly changed to a different constant value not known *a priori*. Notice that this case corresponds to tracking a piecewise constant reference signal.

III. MPC FOR TRACKING

In this section, the proposed MPC for tracking is presented. The key of this formulation is the addition of an artificial reference y_s as an extra decision variable in the optimal control problem to avoid the possible loss of feasibility derived from changes in the setpoint. The convergence to the (actual) setpoint y_t is achieved by adding the term $V_O(y_s - y_t)$ that penalizes the deviation between the artificial reference

y_s and the setpoint y_t . In order to ensure asymptotic stability a terminal cost function and a terminal constraint are added. These are based on a suitable terminal control law $u = \kappa(x, y_s)$ [27]. Besides, as proposed in [24], a prediction horizon N_p larger than the control horizon N_c is considered. Next, the optimization problem and the conditions that the design parameters have to fulfill in order to ensure asymptotic stability are presented. In the following section, a simple choice of these ingredients will be shown.

For a given state x and setpoint y_t , the cost function of the proposed MPC is given by:

$$\begin{aligned} V_{N_c, N_p}(x, y_t; \mathbf{u}, y_s) &= \sum_{j=0}^{N_c-1} \ell(x(j) - x_s, u(j) - u_s) \\ &+ \sum_{j=N_c}^{N_p-1} \ell(x(j) - x_s, \kappa(x(j), y_s) - u_s) \\ &+ V_f(x(N_p) - x_s, y_s) + V_O(y_s - y_t) \end{aligned} \quad (8)$$

where \mathbf{u} is a given sequence of control inputs $\{u(0), \dots, u(N_c - 1)\}$, y_s is the artificial reference, $x(j) = \phi(j; x, \mathbf{u})$, $x_s = g_x(y_s)$ and $u_s = g_u(y_s)$. The function $\ell : \mathbb{R}^n \times \mathbb{R}^m \rightarrow \mathbb{R}$ is the stage cost function, the function $V_f : \mathbb{R}^n \rightarrow \mathbb{R}$ is the terminal cost function and the function $V_O : \mathbb{R}^p \rightarrow \mathbb{R}$ is the offset cost function and all of them are positive definite functions. Notice that the first three terms of $V_{N_c, N_p}(\cdot)$ penalize the predicted tracking error with respect to the artificial reference y_s , while the deviation between the artificial reference and the setpoint ($y_s - y_t$) is penalized by the offset cost function.

In order to derive the stability conditions, it is convenient to extend the notion of invariant set for tracking introduced in [21], [16] to the nonlinear case, which is defined as follows:

Definition 1 (Invariant set for tracking): For a given set of constraints \mathcal{Z} , a set of feasible setpoints $\mathcal{Y}_t \subseteq \mathcal{Y}_s$ and a local control law $u = \kappa(x, y_s)$, a set $\Gamma \subset \mathbb{R}^n \times \mathbb{R}^p$ is an (admissible) invariant set for tracking for system (1) if for all $(x, y_s) \in \Gamma$ we have that $(x, \kappa(x, y_s)) \in \mathcal{Z}$, $y_s \in \mathcal{Y}_t$, and $(f(x, \kappa(x, y_s)), y_s) \in \Gamma$. ■

This set can be read as the set of initial states and setpoints (x, y_s) that provide an admissible evolution of the system (1) controlled by the control law $u = \kappa(x, y_s)$ with a constant reference y_s .

The MPC for tracking control law is derived from the solution of the optimization problem $P_{N_c, N_p}(x, y_t)$ given by:

$$\min_{\mathbf{u}, y_s} V_{N_c, N_p}(x, y_t; \mathbf{u}, y_s) \quad (9a)$$

s.t.

$$x(0) = x, \quad (9b)$$

$$x(j+1) = f(x(j), u(j)), \quad j=0, \dots, N_c-1 \quad (9c)$$

$$(x(j), u(j)) \in \mathcal{Z}, \quad j=0, \dots, N_c-1 \quad (9d)$$

$$x(j+1) = f(x(j), \kappa(x(j), y_s)), \quad j=N_c, \dots, N_p-1 \quad (9e)$$

$$(x(j), \kappa(x(j), y_s)) \in \mathcal{Z}, \quad j=N_c, \dots, N_p-1 \quad (9f)$$

$$x_s = g_x(y_s), \quad u_s = g_u(y_s), \quad (9g)$$

$$(x(N_p), y_s) \in \Gamma. \quad (9h)$$

Notice that constraints (9g) could be replaced by

$$\begin{aligned} x_s &= f(x_s, u_s) \\ y_s &= h(x_s, u_s) \end{aligned}$$

being x_s and u_s new decision variables. This set of constraints are suitable when the functions $g_x(\cdot)$ and $g_u(\cdot)$ are not explicitly known.

The optimal solution to this optimization problem and the optimal cost function will be denoted as $(\mathbf{u}^0(x, y_t), y_s^0(x, y_t))$ and $V_{N_c, N_p}^0(x, y_t)$ respectively. Considering the receding horizon policy, the control law is given by

$$\kappa_{N_c, N_p}(x, y_t) = \mathbf{u}^0(0; x, y_t).$$

It is important to remark that an extended terminal constraint on the terminal state $x(N_p)$ and the artificial steady output y_s is used. Besides, since the set of constraints of $P_{N_c, N_p}(x, y_t)$ does not depend on y_t , its feasible region does not depend on the setpoint y_t . Then there exists a region $\mathcal{X}_{N_c, N_p} \subseteq \mathbb{R}^n$ such that for all $x \in \mathcal{X}_{N_c, N_p}$ and for all $y_t \in \mathbb{R}^p$, the optimization problem $P_{N_c, N_p}(x, y_t)$ is feasible.

The stage cost function, the offset cost function and the set of feasible setpoints must fulfill the following assumptions:

Assumption 2:

- 1) There exists a \mathcal{K}_∞ function α_ℓ such that $\ell(z, v) \geq \alpha_\ell(|z|)$ for all $(z, v) \in \mathbb{R}^{n+m}$.
- 2) The set of feasible setpoints \mathcal{Y}_t is a convex subset of \mathcal{Y}_s .
- 3) The offset cost function $V_O : \mathbb{R}^p \rightarrow \mathbb{R}$ is a subdifferentiable convex positive definite function such that the minimizer

$$y_s^* = \arg \min_{y_s \in \mathcal{Y}_t} V_O(y_s - y_t)$$

is unique. Moreover, there exists a \mathcal{K}_∞ function α_O such that

$$V_O(y_s - y_t) - V_O(y_s^* - y_t) \geq \alpha_O(|y_s - y_s^*|).$$

Remark 2: If the set \mathcal{Y}_s is convex, then set \mathcal{Y}_t can be chosen to be equal to \mathcal{Y}_s . For instance, in the case that the dimension of the output subspace is $p = 1$ and set \mathcal{Y}_s is connected, then $\mathcal{Y}_t = \mathcal{Y}_s$.

In order to ensure asymptotic stability, the terminal ingredients, $\kappa(\cdot)$, $V_f(\cdot)$ and Γ , must fulfill the following conditions:

Assumption 3:

- 1) Let Γ be an invariant set for tracking for the system $x^+ = f(x, \kappa(x, y_s))$.
- 2) Let $\kappa(x, y_s)$ be a control law such that for all $(x, y_s) \in \Gamma$, the equilibrium point $x_s = g_x(y_s)$ and $u_s = g_u(y_s)$ is an asymptotically stable equilibrium point for the system $x^+ = f(x, \kappa(x, y_s))$. Besides, $\kappa(x, y_s)$ is continuous at (x_s, y_s) for all $y_s \in \mathcal{Y}_t$.
- 3) Let $V_f(x - x_s, y_s)$ be a Lyapunov function for system $x^+ = f(x, \kappa(x, y_s))$ such that for all $(x, y_s) \in \Gamma$ there exist constants $b > 0$ and $\sigma > 1$ which verify

$$V_f(x - x_s, y_s) \leq b|x - x_s|^\sigma$$

and

$$\begin{aligned} V_f(f(x, \kappa(x, y_s)) - x_s, y_s) - V_f(x - x_s, y_s) \leq \\ -\ell(x - x_s, \kappa(x, y_s) - u_s) \end{aligned}$$

where $x_s = g_x(y_s)$ and $u_s = g_u(y_s)$. ■

Notice that the assumptions on the terminal ingredients are similar to the ones presented in [27] but extended to hold for any constant reference contained in a set of equilibrium points. These assumptions require the calculation of a control law capable to locally asymptotically stabilize the system to any steady state contained in the set \mathcal{Y}_t . This is a standard tracking control problem and it is also present in the design of other controllers such as the command governors, [2], [3], [8], [9]. Since the conditions to be fulfilled by the terminal ingredients are required to hold only locally, a number of existing techniques could be used, such as those based on the linearization of the plant [30, p.145]. In order to make the paper self-contained, a design procedure is presented in appendix B. This method is based on the LTV modeling technique and the partition method proposed in [33], [32]. Besides, the following sections are devoted to present two schemes of the proposed controller with a more simple design procedure.

The following theorem presents the main result of this paper. It ensures the closed-loop stability and convergence of the system controlled by the MPC for tracking. For the sake of clarity, the proof can be found in Appendix A.

Theorem 1 (Asymptotic Nominal Stability):

Suppose that Assumptions 1, 2 and 3 hold and consider a given constant setpoint y_t . Then for any feasible initial state $x_0 \in \mathcal{X}_{N_c, N_p}$, the system controlled by the MPC controller $\kappa_{N_c, N_p}(x, y_t)$ derived from the solution of (9) is stable, fulfills the constraints throughout the time and converges to an equilibrium point such that

- (i) If $y_t \in \mathcal{Y}_t$ then $\lim_{k \rightarrow \infty} |y(k) - y_t| = 0$.
- (ii) If $y_t \notin \mathcal{Y}_t$, then $\lim_{k \rightarrow \infty} |y(k) - y_s^*| = 0$, where

$$y_s^* = \arg \min_{y_s \in \mathcal{Y}_s} V_O(y_s - y_t).$$

Remark 3 (Stability for piece-wise constant references): Given that the set of constraints of the optimization problem $P_{N_c, N_p}(x, y_t)$ does not depend on the setpoint y_t , the proposed controller is recursively feasible for any given setpoint. Furthermore, if the setpoint remains constant for a sufficiently large period of time then the controller steers asymptotically the output to the best reachable reference y_s^* .

Therefore, if the setpoint changes from a constant value to a different constant value, i.e. step changes of the setpoint signal, then the controller maintains the feasibility and steers the system to the best possible equilibrium point for the new value of the setpoint irrespective of the amplitude of the change.

Remark 4: Since for all $N_p \geq N_c$, $\mathcal{X}_{N_c, N_p} \subseteq \mathcal{X}_{N_c, N_p+1}$, the domain of attraction of the controller can be enlarged by increasing the prediction horizon N_p [24]. However, the result of Theorem 1 and the stability proof are still valid if a formulation with $N = N_c = N_p$ is chosen.

A. A simple stabilizing design: terminal equality constraint

From a practical point of view, it is interesting to find simple methods to derive the terminal ingredients. The most simple way to design the proposed MPC for tracking is considering that $N_p = N_c = N$ and the terminal state reaches the artificial steady state. This is equivalent to choose the terminal control law as the steady input of the artificial reference, that is $\kappa(x, y_s) = g_u(y_s)$, and the set $\Gamma = \{(x, y_s) : x = g_x(y_s), y_s \in \mathcal{Y}_t\}$ as the terminal constraint.

In this case, the cost function is given by:

$$V_N(x, y_t; \mathbf{u}, y_s) = \sum_{j=0}^{N-1} \ell((x(j) - x_s), (u(j) - u_s)) + V_O(y_s - y_t).$$

Notice that no terminal cost function is added, i.e. $V_f(\cdot) = 0$. The controller is derived from the solution of the optimization problem $P_N(x, y_t)$ given by:

$$\min_{\mathbf{u}, y_s} V_N(x, y_t; \mathbf{u}, y_s) \quad (10a)$$

s.t.

$$x(0) = x, \quad (10b)$$

$$x(j+1) = f(x(j), u(j)), j=0, \dots, N-1 \quad (10c)$$

$$(x(j), u(j)) \in \mathcal{Z}, \quad j=0, \dots, N-1 \quad (10d)$$

$$x_s = g_x(y_s), u_s = g_u(y_s) \quad (10e)$$

$$y_s \in \mathcal{Y}_t \quad (10f)$$

$$x(N) = x_s. \quad (10g)$$

Notice that constraints (10f) and (10g) are equivalent to adding the terminal condition $(x(N), y_s) \in \Gamma = \{(x, y_s) : x = g_x(y_s), y_s \in \mathcal{Y}_t\}$. Then, the proposed choice of the terminal ingredients can be posed as a terminal equality constraint.

As it is usual in MPC with terminal equality constraint, a controllability assumption is required [30, Assumption 2.23] to derive asymptotic stability. In this case, the following controllability condition is stated.

Assumption 4:

The model function $f(x, u)$ is differentiable at any equilibrium point $(x_s, u_s) \in \mathcal{Z}_s$ and the linearized model given by the matrices $(A(x_s, u_s), B(x_s, u_s))$ is controllable. Furthermore, there exist positive constants $\varepsilon, b > 0$ and $\sigma > 1$ such that

$$\sum_{i=0}^{N-1} \ell(x(i) - x_s, u(i) - u_s) \leq b|x - x_s|^\sigma$$

holds for any feasible solution (\mathbf{u}, y_s) of $P_N(x, y_t)$ such that $|x - x_s| \leq \varepsilon$ and $|u(i) - u_s| \leq \varepsilon$. ■

This condition is similar to [30, Assumption 2.23] with the additional condition that the upper bound \mathcal{K}_∞ function is exponential. This condition holds, for instance, if the stage cost is locally upper-bounded by a quadratic function and the linearized model at each equilibrium point is controllable.

The following theorem proves asymptotic stability and constraints satisfaction of the controlled system. The proof can be found in Appendix A.

Theorem 2 (Asymptotic Nominal Stability):

Consider that assumptions 1, 2 and 4 hold and the prediction horizon satisfies $N \geq n$. Then for any setpoint y_t and for any feasible initial state $x_0 \in \mathcal{X}_N$, the system controlled by the MPC controller $\kappa_N(x, y_t)$ derived from the solution of (10) is stable, converges to an equilibrium point, fulfills the constraints throughout the time and besides

- (i) If $y_t \in \mathcal{Y}_t$ then $\lim_{k \rightarrow \infty} |y(k) - y_t| = 0$.
- (ii) If $y_t \notin \mathcal{Y}_t$, then $\lim_{k \rightarrow \infty} |y(k) - y_s^*| = 0$, where

$$y_s^* = \arg \min_{y_s \in \mathcal{Y}_t} V_O(y_s - y_t)$$

■

Stability for any piece-wise constant reference signal stated in Remark 3 holds also in this case.

The MPC for tracking based on the equality constraint is very simple to design and ensures closed-loop stability. However, it has also some drawbacks with respect to the general case: (i) the domain of attraction is potentially smaller, that is, $X_{N_c} \subseteq X_{N_c, N_p}$ and (ii) the benefits of using a prediction horizon larger than the control horizon in terms of closed-loop performance [24] may be lost. In the following section it is presented a method to design a stabilizing MPC for tracking with $N_p > N_c$ such that the terminal constraint is removed from the optimization problem.

B. Stabilizing design without terminal constraint

The stabilizing design of MPC based on terminal ingredients requires the calculation of the terminal control law, the terminal cost function and the terminal region. While the calculation of the first two ingredients can be done by using efficient techniques, the calculation of the terminal region may be cumbersome. This has motivated the study of stabilizing predictive controllers without terminal constraint (see section 2.2.1 in [28]). In this section, it is shown how to design the proposed controller when the terminal constraint is removed from the optimization problem.

The following results are the extension of [20] to the case of MPC for tracking with a prediction horizon larger than the control horizon.

Consider that $V_f(x - x_s, y_s)$ is a terminal cost function and $\kappa(x, y_s)$ a terminal control law that satisfy Assumption 3. Define the region Γ_α as follows

$$\Gamma_\alpha = \{(x, y_s) : V_f(x - g_x(y_s), y_s) \leq \alpha\} \quad (11)$$

such that Γ_α is an invariant set for tracking. Notice that there exists a constant $\alpha > 0$ satisfying this condition since for all reachable setpoint in \mathcal{Y}_t , the constraints are not active thanks to the condition (4).

Let $V_{N_c, N_p}^\gamma(x, y_t; \mathbf{u}, y_s)$ be the cost function (9) considering a weighted terminal cost function $\gamma V_f(x - x_s, y_s)$. Then the optimization problem without terminal constraint, $P_{N_c, N_p}^\gamma(x, y_t)$, is given by:

$$\min_{\mathbf{u}, y_s} V_{N_c, N_p}^\gamma(x, y_t; \mathbf{u}, y_s) \quad (12a)$$

$$\text{s.t.} \quad (9b) - (9g) \quad (12b)$$

Let $V_{N_c, N_p}^{\gamma, 0}(x, y_t)$ be the optimal cost of $P_{N_c, N_p}^\gamma(x, y_t)$ and define the following level set

$$\Upsilon_{N_p, \gamma}(y_t) = \{x : V_{N_c, N_p}^{\gamma, 0}(x, y_t) - V_O(y_s^* - y_t) \leq N_p d + \gamma \alpha\}$$

where d is a positive constant such that $\ell(x - g_x(y_s), u - g_u(y_s)) \geq d$ for all $(x, y_s) \notin \Gamma_\alpha$ (see Lemma 4 in the appendix).

Then we can state the following theorem.

Theorem 3: Consider that Assumptions 1, 2 and 3 hold and consider a given setpoint y_t . Let $\kappa_{N_c, N_p}^\gamma(x, y_t)$ be the predictive control law derived from $P_{N_c, N_p}^\gamma(x, y_t)$ for any $\gamma \geq 1$. Then for all $x(0) \in \Upsilon_{N_p, \gamma}(y_t)$, the system controlled by $\kappa_{N_c, N_p}^\gamma(x, y_t)$ is stable, converges to an equilibrium point, fulfills the constraints throughout the time and besides

- (i) If $y_t \in \mathcal{Y}_t$ then $\lim_{k \rightarrow \infty} |y(k) - y_t| = 0$.
- (ii) If $y_t \notin \mathcal{Y}_t$, then $\lim_{k \rightarrow \infty} |y(k) - y_s^*| = 0$, where

$$y_s^* = \arg \min_{y_s \in \mathcal{Y}_s} V_O(y_s - y_t)$$

The proof of this theorem can be found in Appendix A. Furthermore, stability for any piece-wise constant reference signal stated in Remark 3 holds also in this case.

From this theorem and from [20], the following property can be derived.

Property 1: The stability region $\Upsilon_{N_p, \gamma}(y_t)$ is enlarged as the prediction horizon N_p and/or the weighting factor γ is enlarged.

In order to use this result in a practical case, an estimation of these parameters would be interesting. The following property gives an explicit formula that allows us to get a domain of attraction larger than the one of the proposed controller with equality constraint.

Property 2: Assume that \mathcal{Z} is a compact set. Let D be a constant such that $\ell(x - x_s, u - u_s) \leq D$ for all $(x, u) \in \mathcal{Z}$ and $(x_s, u_s) \in \mathcal{Z}_s$. Let \hat{V}_O be a constant such that $V_O(y_s - y_t) \leq \hat{V}_O$ for all $y_s \in \mathcal{Y}_t$ and for all possible y_t . Define the constant γ_0 as

$$\gamma_0 = \max \left(\frac{N_c D - N_p d + \hat{V}_O}{\alpha}, 1 \right)$$

Then

- (i) $\Upsilon_{N_p, \gamma_0}(y_t)$ contains the domain of attraction of the controller with terminal equality constraint, i.e. \mathcal{X}_{N_c}
- (ii) For any $\gamma \geq \gamma_0$, the set $\Upsilon_{N_p, \gamma}(y_t)$ contains the domain of attraction of the controller with a prediction and control horizon equal to N_c and the terminal constraint set $\Gamma_{\rho\alpha}$, where $\rho = 1 - \frac{\gamma_0}{\gamma}$.

The proof of this property can be found in Appendix A.

Remark 5: From the latter properties it can be proved that if the initial state x_0 is a feasible equilibrium point, i.e. $x_0 = g_x(y_0)$ with $y_0 \in \mathcal{Y}_t$, then the MPC for tracking without terminal constraint asymptotically stabilizes the system for all N_p and γ such that

$$N_p d + \gamma \alpha \geq \hat{V}_O$$

This is derived from the fact that applying the equilibrium input $u_0 = g_u(y_0)$ the system remains at the equilibrium point, which is feasible. Then taking a suboptimal solution such that $u(i) = u_0$ and $y_s = y_0$, we have that

$$V_N^{\gamma, 0}(x_0) \leq V_O(y_0 - y_t) \leq \hat{V}_O \leq N_p d + \gamma \alpha$$

which demonstrates that $x_0 \in \Upsilon_{N_p, \gamma}(y_t)$

Remark 6: Notice that the set $\Upsilon_{N_p, \gamma}(y_t)$ depends on the prediction horizon N_p , not on the control horizon N_c . This set is then larger than the one presented in [20], even for the regulation case.

IV. PROPERTIES OF THE MPC FOR TRACKING

It has been shown that the proposed controller ensures closed-loop stability and convergence to the best admissible equilibrium point in \mathcal{Y}_t . Additionally, this controller has some other interesting properties that are detailed next.

A. Stability for any admissible setpoint

From the stability theorems it can be derived that if the initial state is feasible, then the proposed controller is able to track any setpoint $y_t \in \mathcal{Y}_s$.

However, in practice, it may be difficult to know beforehand if the current state is in the feasible region in order to close the loop with the controller. In real applications, it is common practice that the plant is manually operated to an admissible equilibrium point before closing the control loop. Then assuming that the initial state is an admissible equilibrium point (x_0, u_0) such that $y_0 \in \mathcal{Y}_t$, the proposed controller ensures that the optimization problem would be feasible and the proposed controller would steer the system to the given setpoint $y_t \in \mathcal{Y}_t$ under the assumptions of the stability theorems. This is derived from the fact that in this case, the steady state x_0 is contained in the domain of attraction of the proposed controller even if $N_c = 1$ (or n , in the case of terminal equality constraint). Particularly interesting is the case of the MPC for tracking without terminal constraint, which can drive the plant to any setpoint $y_t \in \mathcal{Y}_t$ with $N_c = 1$ and taking $\gamma \geq \frac{\hat{V}_O + D - d}{\alpha}$.

B. Enlargement of the domain of attraction

The domain of attraction of the standard MPC to regulate the system to the setpoint y_t , $\mathcal{X}_{N_c, N_p}(y_t)$ is the set of initial states that can be admissible steered to (a neighborhood of) $x_t = g_x(y_t)$ in N_p steps. On the other hand, the domain of attraction of the proposed controller, \mathcal{X}_{N_c, N_p} , is the set of states that can be admissible steered to *any* setpoint $y_s \in \mathcal{Y}_t$, not only to y_t . This can be read as

$$\mathcal{X}_{N_c, N_p} = \bigcup_{y_s \in \mathcal{Y}_t} \mathcal{X}_{N_c, N_p}(y_s)$$

Then the domain of attraction of the proposed controller is (potentially) larger than the domain of the standard MPC for regulation. This property is particularly interesting for small values of the control horizon and makes the proposed controller interesting even in case of a fixed setpoint.

It is worth remarking that the feasibility and implementation problems that arise when a stabilizing MPC with equality

constraint is adopted are typically derived from the terminal equality constraint. However, in the proposed MPC this terminal equality constraint is not hard to satisfy, since the terminal state x_s is actually a decision variable of the optimization problem, making this controller more appealing.

This property is illustrated in the example of Section V.

C. Steady state optimization for unreachable setpoints

It is not unusual that the given setpoint y_t is unreachable, that is, it is not contained in \mathcal{Y}_t . This may happen when the provided setpoint is not consistent with the prediction model or when the associated equilibrium point is not consistent with the constraints considered in the optimization problem. From the theorems it can be clearly seen that in this case, the proposed controller maintains the recursive feasibility and steers the system to the optimal operating point according to the offset cost function $V_O(\cdot)$, that is, to the admissible equilibrium point that minimizes the offset cost function. Then this function serves as a measure of the cost of the offset in case of unreachable setpoints. Therefore, the offset cost function can be chosen in order to define where the system should converge in case of unreachable setpoints.

D. Local optimality

It is well known that the MPC for regulation is equal to the infinite-horizon optimal controller if the terminal controller and the terminal cost function are the local optimal controller and optimal cost function respectively [30]. However, the proposed MPC for tracking can be considered as a suboptimal controller due to the addition of the artificial reference and the chosen cost function to be optimized. It is now proved that under a mild assumption on the offset cost function, the MPC for tracking locally provides the same solution than the standard MPC for regulation, recovering its local optimality property.

To this aim, the offset cost function must ensure the following mild assumption.

Assumption 5: Let the offset cost function fulfill Assumption 2. Moreover there exists a positive constant μ such that:

$$V_O(y_s - y_t) \geq \mu |y_s - y_t|$$

where $|\cdot|$ denotes a certain norm.

In order to demonstrate this property, it is interesting to see that the standard MPC control law for regulation to a setpoint $y_t \in \mathcal{Y}_s$, $k_{N_c, N_p}^r(x, y_t)$ can be derived from the optimization problem of the proposed controller but forcing that $y_s = y_t$, that is, from the solution of the following optimization problem $P_{N_c, N_p}^r(x, y_t)$:

$$\begin{aligned} V_{N_c, N_p}^{r,0}(x, y_t) &= \min_{\mathbf{u}, y_s} V_{N_c, N_p}(x, y_t; \mathbf{u}, y_s) \\ \text{s.t.} \quad &(9b) - (9g) \\ &|y_s - y_t|_d = 0 \end{aligned}$$

where the norm $|\cdot|_d$ is chosen to be the dual norm of $|\cdot|$, namely $|z|_d = \max_{|v| \leq 1} z'v$ [23]. The domain of attraction of this problem is a compact set noted as $\mathcal{X}_{N_c, N_p}^r(y_t)$. Then the ideas

presented in [21], [14] can be extended to the nonlinear case, yielding to the following property that is proved in Appendix A.

Property 3: Consider that Assumptions 1, 2 and 5 hold. Assume that the solution of the optimization problem $P_{N_c, N_p}(x, y_t)$ is unique. Then there exists a μ^* such that for all $\mu \geq \mu^*$ and for all $x \in \mathcal{X}_{N_c, N_p}^r(y_t)$, the MPC for tracking equals the MPC for regulation, that is $k_{N_c, N_p}(x, y_t) = k_{N_c, N_p}^r(x, y_t)$

Remark 7: The last property is strictly related to the rate of convergence of the proposed controller: the larger the value of μ , the faster the convergence. Moreover, if $\mu \geq \mu^*$, then the rate of convergence is the same as the one of the standard MPC for regulation.

V. AN ILLUSTRATIVE EXAMPLE

In this section, some examples are presented to show the properties of the presented controller.

A. Enlargement of the domain of attraction

The aim of this example is to show the property of enlargement of the domain of attraction of the proposed controller. The system considered is a continuous stirred tank reactor (CSTR), [8], [24]. Assuming constant liquid volume, the CSTR for an exothermic, irreversible reaction, $A \rightarrow B$, is described by the following model:

$$\begin{aligned} \dot{C}_A &= \frac{q}{V}(C_{Af} - C_A) - k_o e^{\left(\frac{-E}{RT}\right)} C_A \\ \dot{T} &= \frac{q}{V}(T_f - T) - \frac{\Delta H}{\rho C_p} k_o e^{\left(\frac{-E}{RT}\right)} C_A + \frac{UA}{V\rho C_p}(T_c - T) \end{aligned} \quad (13)$$

where C_A is the concentration of A in the reactor (mol/l), T is the reactor temperature (K) and T_c is the temperature of the coolant stream (K). The nominal operating conditions are: $q = 100$ l/min, $T_f = 350$ K, $V = 100$ l, $\rho = 1000$ g/l, $C_p = 0.239$ J/g K, $\Delta H = -5 \times 10^4$ J/mol, $E/R = 8750$ K, $k_o = 7.2 \times 10^{10} \text{min}^{-1}$, $UA = 5 \times 10^4$ J/min K and $C_{Af} = 1$ mol/l.

The objective is to regulate $y = x_2 = T$ and $x_1 = C_A$ by manipulating $u = T_c$. The constraints are $0 \leq C_A \leq 1$ mol/l, $280\text{K} \leq T \leq 370\text{K}$ and $280\text{K} \leq T_c \leq 370$ K. The nonlinear discrete time model of system (13) is obtained by discretizing equation (13) using a 5-th order Runge-Kutta method and taking as sampling time 0.03 min. The set of reachable output is given by $304.17\text{K} \leq T \leq 370\text{K}$.

The stage cost function is $l(x, u) = |x - x_s|_Q^2 + |u - u_s|_R^2$ where Q is a diagonal matrix which main diagonal is $(1, 1/100)$, and $R = 1/100$. The function $V_O = \alpha |y_s - y_t|_\infty$, with $\alpha = 100$ has been chosen as offset cost function. The prediction and control horizons are $N_p = N_c = N$. The terminal condition used is the equality constraint. The controller has been implemented in MATLAB using the function `fmincons` to solve the optimization problem.

In the test the objective is to evaluate the feasible set of the MPC for tracking for different values of the horizon N . The system has been considered to be steered to the setpoint $y_t = 336.9$ that corresponds to the setpoint $x_t = (0.7255, 336.9)$

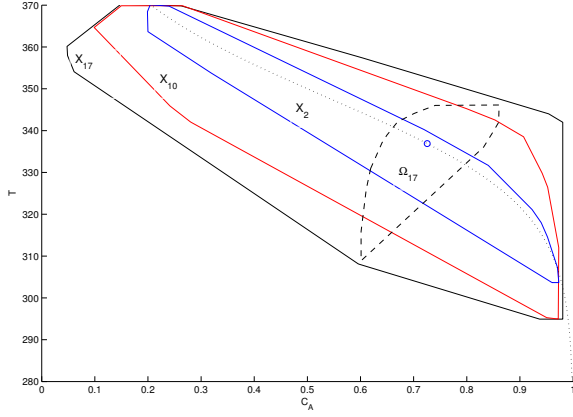

Fig. 1. Domains of attraction of the MPC for tracking with terminal equality constraints for $N = 2, 10, 17$ and domain of attraction of the MPC for regulation with $N = 17$.

and $u_t = 303.19$, which is an admissible equilibrium point. The initial condition is $x_0 = (0.7950, 332)$, $u_0 = 302.8986$.

The domains of attraction are drawn in Figure 1, and they have been estimated for $N = 2$, $N = 10$ and $N = 17$, using the *Phase I* algorithm [5]. The controller has been compared with a standard MPC for regulation, whose horizon has been chosen as $N = 17$. The dotted line represents the steady states manifold of the system. The steady state x_t is represented as a dot. The domain of attraction of the MPC for tracking with $N = 2$, $N = 10$ and $N = 17$, are represented respectively in black, red and blue solid line and are denoted as \mathcal{X}_2 , \mathcal{X}_{10} and \mathcal{X}_{17} . The domain of attraction of the MPC for regulation with $N = 17$ is represented in dashed line and is denoted as Ω_{17} . See how the MPC for tracking always provides a domain of attraction larger than the one given by the MPC for regulation. In the MPC for tracking, the domain of attraction is the set of initial state that can reach *any* equilibrium point in N steps. This fact is particularly evident in Figure 1, since it can be seen that the domain of attraction of all MPC for tracking controllers cover the entire admissible steady state manifold even for $N = 2$.

B. MPC with terminal inequality constraint

In this case, a formulation with $N_p > N_c$ has been used, taking $N_c = 2$ and $N_p = 20$.

The terminal ingredients have been calculated using the LTV modelling in partitions algorithm presented in Appendix B. To this aim, the steady-state manifold of the system has been divided in 4 partitions, given by $\mathcal{Y}_{s_1} = [304.17; 320]$, $\mathcal{Y}_{s_2} = [320; 340]$, $\mathcal{Y}_{s_3} = [340; 355]$ and $\mathcal{Y}_{s_4} = [355; 370]$ respectively. The terminal ingredients obtained for each region are, respectively:

- \mathcal{Y}_{s_1}

$$K_1 = \begin{bmatrix} 0.0813 & -0.00084 \end{bmatrix}$$

$$P_1 = \begin{bmatrix} 1960.6824 & 0.0784 \\ 0.0784 & 0.1133 \end{bmatrix}$$

- \mathcal{Y}_{s_2}

$$K_2 = \begin{bmatrix} -14.7111 & -4.9762 \end{bmatrix}$$

$$P_2 = \begin{bmatrix} 130.6951 & 0.0320 \\ 0.0320 & 0.0871 \end{bmatrix}$$

- \mathcal{Y}_{s_3}

$$K_3 = \begin{bmatrix} -68.1506 & -10.1395 \end{bmatrix}$$

$$P_3 = \begin{bmatrix} 467.4119 & -1.3908 \\ -1.3908 & 0.3197 \end{bmatrix}$$

- \mathcal{Y}_{s_4}

$$K_4 = \begin{bmatrix} -77.8550 & -14.9994 \end{bmatrix}$$

$$P_4 = \begin{bmatrix} 4566.6258 & -19.1039 \\ -19.1039 & 0.8013 \end{bmatrix}$$

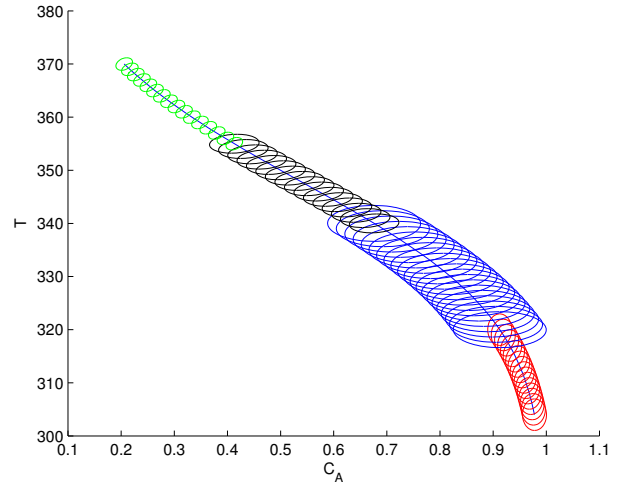

Fig. 2. Different terminal regions Γ_i for the CSTR: Γ_1 in red line, Γ_2 in blue line, Γ_3 black line, Γ_4 in green line.

The obtained regions are shown in Figure 2. Notice how the regions calculated for the four partitions, cover the entire steady state manifold. The union of these regions provides the invariant set for tracking to be used as terminal constraints.

Two changes of reference have been simulated to the setpoints $y_{t,1} = 365$ and $y_{t,2} = 308$, starting from the initial condition $y_0 = 308$.

The time evolution of the system is plotted in Figure 3. The system evolution, the artificial reference and the reference y_t are drawn respectively in solid, dashed, and dashed-dotted line. It can be observed that the controller always steers the system to the desired setpoint, even if the system is subject to a big change of reference. This is due to the use of the artificial reference which ensures feasibility for any change of setpoint.

The domain of attraction of the MPC for tracking with terminal inequality constraint with horizons $N_c = 2$ and $N_p = 20$, $\mathcal{X}_{2,20}$, is plotted in Figure 4 in black solid line. In the figure, this set is compared to the domain of attraction of the MPC for tracking with terminal equality constraint, for $N = 2$, \mathcal{X}_2 , which is plotted in blue solid line. The steady state manifold is plotted in dotted line. See how the set $\mathcal{X}_{2,20}$ results to be larger than the set \mathcal{X}_2 due to the use of a prediction horizon N_p larger than the control horizon N_c .

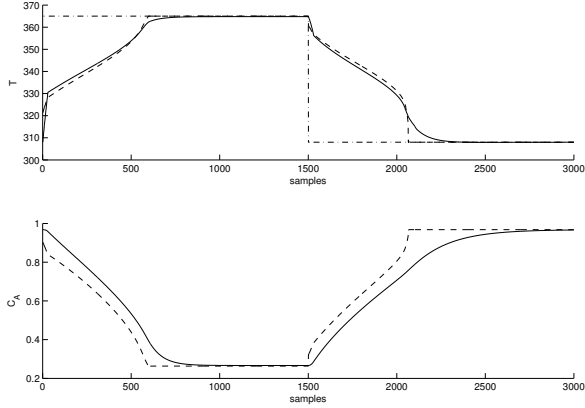

Fig. 3. Time evolution of the system state (solid line), the artificial equilibrium state (dashed line) and the reference signal (dashed-dotted line).

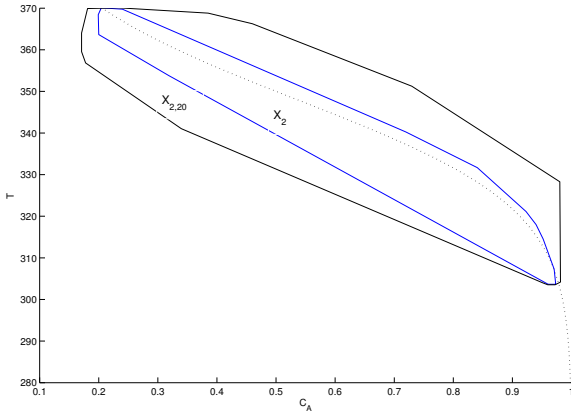

Fig. 4. Comparison of the domains of attraction of the MPC for tracking with terminal inequality constraint, with $N_c = 2$ and $N_p = 20$ and the MPC for tracking with terminal equality constraint, with $N = 2$.

VI. APPLICATION TO A REAL PLANT

The presented controller has been applied to the 4 tanks plant located at the process control laboratory of the University of Seville.

The four tanks plant [18] is a multivariable laboratory plant of interconnected tanks with nonlinear dynamics and subject to state and input constraints. A scheme of this plant is presented in Figure 5(a). The real experimental plant developed at the University of Seville [1] is presented in Figure 5(b).

The nonlinear continuous time model of the quadruple tank process system [18] can be derived from first principles as follows

$$\frac{dh_1}{dt} = -\frac{a_1}{S}\sqrt{2gh_1} + \frac{a_3}{S}\sqrt{2gh_3} + \frac{\gamma_a}{3600S}q_a \quad (14a)$$

$$\frac{dh_2}{dt} = -\frac{a_2}{S}\sqrt{2gh_2} + \frac{a_4}{S}\sqrt{2gh_4} + \frac{\gamma_b}{3600S}q_b \quad (14b)$$

$$\frac{dh_3}{dt} = -\frac{a_3}{S}\sqrt{2gh_3} + \frac{(1-\gamma_b)q_b}{3600S} \quad (14c)$$

$$\frac{dh_4}{dt} = -\frac{a_4}{S}\sqrt{2gh_4} + \frac{(1-\gamma_a)q_a}{3600S} \quad (14d)$$

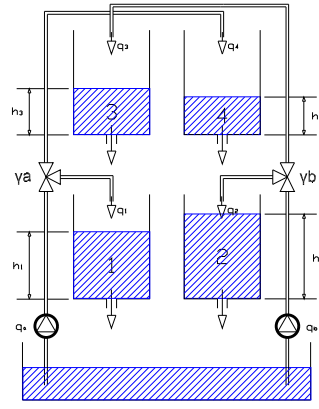

(a) Scheme of the 4 tank process.



(b) The real plant.

Fig. 5. The 4 tanks process.

The plant parameters, estimated on the real plant are shown in the following table:

	Value	Unit	Description
H_{1max}	1.36	m	Maximum level of the tank 1
H_{2max}	1.36	m	Maximum level of the tank 2
H_{3max}	1.30	m	Maximum level of the tank 3
H_{4max}	1.30	m	Maximum level of the tank 4
H_{min}	0.2	m	Minimum level in all cases
V_{max}	0.2226	m^3	Maximum volume of water
Q_{amax}	3.6	m^3/h	Maximum flow of pump A
Q_{bmax}	4	m^3/h	Maximum flow of pump B
Q_{min}	0	m^3/h	Minimal flow
Q_a^0	1.63	m^3/h	Equilibrium flow (Q_a)
Q_b^0	2.0000	m^3/h	Equilibrium flow (Q_b)
a_1	1.2938e-4	m^2	Discharge constant of tank 1
a_2	1.5041e-4	m^2	Discharge constant of tank 2
a_3	1.0208e-4	m^2	Discharge constant of tank 3
a_4	9.3258e-5	m^2	Discharge constant of tank 4
S	0.06	m^2	Cross-section of all tanks
γ_a	0.3		Parameter of the 3-ways valve
γ_b	0.4		Parameter of the 3-ways valve
h_1^0	0.6702	m	Equilibrium level of tank 1
h_2^0	0.6549	m	Equilibrium level of tank 2
h_3^0	0.5435	m	Equilibrium level of tank 3
h_4^0	0.5887	m	Equilibrium level of tank 4

The minimum level of the tanks has been taken greater than zero to prevent eddy effects in the discharge of the tank.

One important property of this plant is that the dynamics present multivariable transmission zeros which can be located in the right hand side of the s plane for some operating conditions. Hence, the values of γ_a and γ_b have been chosen in order to obtain a system with non-minimum phase multivariable zeros.

The nonlinear discrete time model of system (14) is obtained by discretizing equations (14a)-(14d) using a 5-th order Runge-Kutta method and taking as sampling time $T_s = 15s$.

The MPC for tracking without terminal constraint has been tested on the plant. The horizons used are $N_c = 5$ and $N_p = 20$. The stage cost function used is $l(x, u) = |x - x_s|_Q^2 + |u - u_s|_R^2$ with $Q = I_4$ and $R = 0.01I_2$ as weighting matrices. The function $V_O = \alpha|y_s - y_t|_\infty$, with $\alpha = 100$ has been chosen

as offset cost function. The cost-to-go is taken of the form $V_f(x - x_s, y_s) = (x - x_s)'P(x - x_s)$. The gain matrix K for terminal control law and the matrix P for the cost-to-go have been calculating by solving an LMI problem, and are given by:

$$K = \begin{bmatrix} -0.0282 & 0.0916 & 0.1384 & -0.4479 \\ 0.0883 & 0.0439 & -0.4553 & 0.4704 \end{bmatrix}$$

$$P = \begin{bmatrix} 10.9654 & 0.6257 & 9.6267 & 1.3360 \\ 0.6257 & 10.2893 & 0.7929 & 8.8616 \\ 9.6267 & 0.7929 & 42.2449 & 5.5129 \\ 1.3360 & 8.8616 & 5.5129 & 38.0525 \end{bmatrix}$$

The weight of the cost-to-go has been calculated following Property 2 and its values is $\gamma_0 = 100.3526$.

In the test, four changes of references have been considered. These references are: $y_{t,1} = (0.65, 0.65)$, $y_{t,2} = (0.35, 0.35)$, $y_{t,3} = (0.6, 0.75)$ and $y_{t,4} = (0.9, 0.75)$.

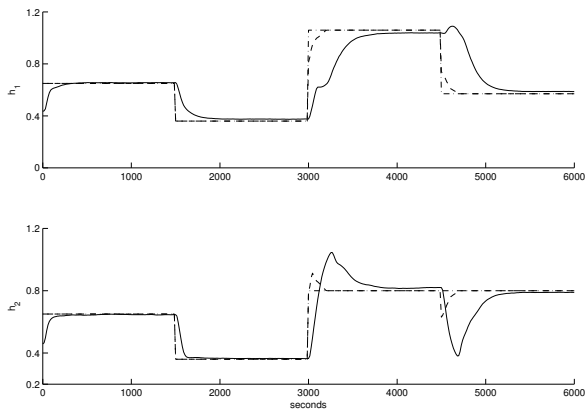

Fig. 6. Time evolutions of the output levels h_1 and h_2 (solid line) and the corresponding artificial equilibrium states (dashed line) and the reference signals (dashed-dotted line).

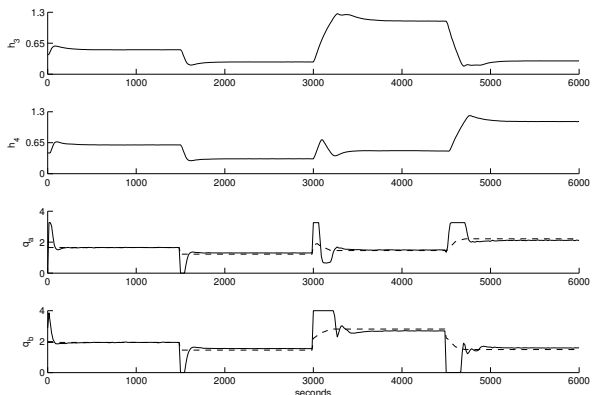

Fig. 7. Time evolutions of the levels h_3 and h_4 and of the input flows q_a and q_b (solid line) and the corresponding artificial equilibrium states and inputs (dashed line).

The results of the test are shown in Figures 6 and 7. In particular, in Figure 6 the time evolution of the output levels h_1 and h_2 is plotted in solid line, while the references and the artificial references are plotted respectively in dashed-dotted and dashed line. It can be seen that the controller always drives the system to the desired setpoint without losing feasibility in any case. The role played by the artificial reference is particular evident in the third change of setpoint, at time $T = 3000s$. This change is too large, and may cause a loss of feasibility. However, the controller is able to maintain feasibility by following the artificial reference. The offset visible in the figure may be due to the noises or model mismatches between the prediction model and the real plant. In Figure 7, the time evolution of the levels h_3 and h_4 are plotted in solid line and the evolution of the input flows q_a and q_b , and the artificial references are plotted respectively in solid and dashed line.

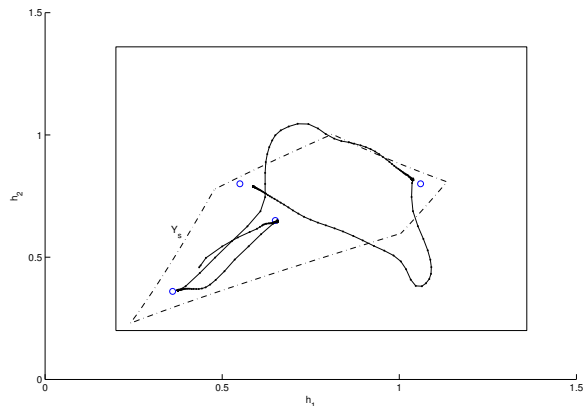

Fig. 8. State space evolution of the outputs and set of the equilibrium output.

The state space evolution of the outputs of the system is drawn in Figure 8. The set of output constraints is plotted in solid line, the set of equilibrium outputs \mathcal{Y}_s is plotted in dashed-dotted line and the references are plotted as blue dots. See how the closed-loop system is driven to the desired setpoint in any case.

VII. CONCLUSIONS

In this paper an MPC for tracking piece-wise constant references for constrained nonlinear system has been presented. This controller considers an artificial reference as additional decision variables and minimizes the tracking error of the predicted trajectory w.r.t. the artificial reference and the distance between this reference and the provided setpoint. The stabilizing design is based on a suitable choice of a terminal cost function and a terminal region. It is proved that stability can be achieved by using a terminal equality constraint and without terminal constraint. Assuming that the reference remains constant a sufficiently large period of time, the controller asymptotically steers the system to the reference if this is admissible. If not, the controlled system converges to the admissible steady state that minimizes the offset cost function.

The properties of the proposed controller have been shown in an illustrative example and tested on a real four tanks plant.

REFERENCES

- [1] I. Alvarado, "Model predictive control for tracking constrained linear systems," Ph.D. dissertation, Univ. de Sevilla., 2007.
- [2] D. Angeli and E. Mosca, "Command governors for constrained nonlinear systems," *IEEE Transactions on Automatic Control*, vol. 44, pp. 816–820, 1999.
- [3] A. Bemporad, "Reference governor for constrained nonlinear systems," *IEEE Transactions on Automatic Control*, vol. 43, pp. 415–419, 1998.
- [4] A. Bemporad, A. Casavola, and E. Mosca, "Nonlinear control of constrained linear systems via predictive reference management," *IEEE Transactions on Automatic Control*, vol. 42, pp. 340–349, 1997.
- [5] S. Boyd and L. Vandenberghe, *Convex Optimization*. Cambridge University Press, 2006.
- [6] E. F. Camacho and C. Bordons, *Model Predictive Control*, 2nd ed. Springer-Verlag, 2004.
- [7] W. W. L. Chen, *Multivariable and vector analysis*, 2nd ed. Macquarie University, 2008. [Online]. Available: <https://rutherglen.science.mq.edu.au/wchen/lnmvafolder/lnmva.html>
- [8] L. Chisci, P. Falugi, and G. Zappa, "Predictive tracking control of constrained nonlinear systems," *IEE Proceedings - Control Theory and Applications*, vol. 152:3, pp. 309–316, 2005.
- [9] L. Chisci and G. Zappa, "Dual mode predictive tracking of piecewise constant references for constrained linear systems," *Int. J. Control*, vol. 76, pp. 61–72, 2003.
- [10] L. Fagiano and A. Teel, "Generalized terminal state constraint for model predictive control," *Automatica*, vol. 49, no. 9, p. 26222631, 2013.
- [11] P. Falugi, "Model predictive control for tracking randomly varying references," *International Journal of Control*, 2014, doi: 10.1080/00207179.2014.972464.
- [12] A. Ferramosca, "Model predictive control for systems with changing setpoints," Ph.D. dissertation, Univ. de Sevilla., 2011, <http://fondosdigitales.us.es/tesis/autores/1537/>.
- [13] A. Ferramosca, D. Limon, I. Alvarado, T. Alamo, and E. F. Camacho, "MPC for tracking constrained nonlinear systems," in *Proceedings of 48th IEEE Conference on Decision and Control, CDC 2009*, Shanghai, China, December, 16-18 2009.
- [14] —, "MPC for tracking with optimal closed-loop performance," *Automatica*, vol. 45, pp. 1975–1978, 2009.
- [15] R. Findeisen, H. Chen, and F. Allgöwer, "Nonlinear predictive control for setpoint families," in *Proc. Of the American Control Conference*, 2000.
- [16] E. Garone, S. Di Cairano, and I. Kolmanovsky, "Reference and command governors for systems with constraints: A survey on theory and applications," *Automatica*, pp. 306–328, 2017.
- [17] E. Gilbert and I. Kolmanovsky, "Nonlinear tracking control in the presence of state and control constraints: A generalized reference governor," *Automatica*, vol. 38, pp. 2063–2073, 2002.
- [18] K. H. Johansson, "The quadruple-tank process," *IEEE Trans. Cont. Sys. Techn.*, vol. 8, pp. 456–465, 2000.
- [19] D. Limon and T. Alamo, "Tracking model predictive control," in *Encyclopedia of Systems and Control*, J. Baillieul and T. Samad, Eds. Springer, 2014.
- [20] D. Limon, T. Alamo, F. Salas, and E. F. Camacho, "On the stability of MPC without terminal constraint," *IEEE Transactions on Automatic Control*, vol. 42, pp. 832–836, 2006.
- [21] D. Limon, I. Alvarado, T. Alamo, and E. F. Camacho, "MPC for tracking of piece-wise constant references for constrained linear systems," *Automatica*, vol. 44, pp. 2382–2387, 2008.
- [22] D. Limon, A. Ferramosca, I. Alvarado, T. Alamo, and E. F. Camacho, "MPC for tracking of constrained nonlinear systems," in *Nonlinear Model Predictive Control. Towards New Challenging Applications*, L. Magni, D. M. Raimondo, and F. Allgöwer, Eds. Springer, 2009, pp. 315–323.
- [23] D. E. Luenberger, *Linear and Nonlinear Programming*. Addison-Wesley, 1984.
- [24] L. Magni, G. De Nicolao, L. Magnani, and R. Scattolini, "A stabilizing model-based predictive control algorithm for nonlinear systems," *Automatica*, vol. 37, pp. 1351–1362, 2001.
- [25] L. Magni, G. De Nicolao, and R. Scattolini, "Output feedback and tracking of nonlinear systems with model predictive control," *Automatica*, vol. 37, pp. 1601–1607, 2001.
- [26] L. Magni and R. Scattolini, "On the solution of the tracking problem for non-linear systems with MPC," *Int. J. of Systems Science*, vol. 36:8, pp. 477–484, 2005.
- [27] D. Q. Mayne, J. B. Rawlings, C. V. Rao, and P. O. M. Sokaert, "Constrained model predictive control: Stability and optimality," *Automatica*, vol. 36, pp. 789–814, 2000.
- [28] D. Mayne, "Model predictive control: Recent developments and future promise," *Automatica*, vol. 50, pp. 2967–2986, 2014.
- [29] G. Pannocchia and E. Kerrigan, "Offset-free receding horizon control of constrained linear systems," *AIChE Journal*, vol. 51, pp. 3134–3146, 2005.
- [30] J. B. Rawlings and D. Q. Mayne, *Model Predictive Control: Theory and Design*, 1st ed. Nob-Hill Publishing, 2009.
- [31] J. A. Rossiter, B. Kouvaritakis, and J. R. Gossner, "Guaranteeing feasibility in constrained stable generalized predictive control," *IEEE Proc. Control theory Appl.*, vol. 143, pp. 463–469, 1996.
- [32] Z. Wan and M. V. Kothare, "Efficient scheduled stabilizing model predictive control for constrained non linear systems," *Int. J. of Robust and Nonlinear Control*, vol. 13, pp. 331–346, 2003.
- [33] Z. Wan and M. Kothare, "An efficient off-line formulation of robust model predictive control using linear matrix inequalities," *Automatica*, vol. 39, pp. 837–846, 2003.

APPENDIX A

PROOF OF THE STABILITY THEOREMS

A. Proof of Theorem 1

This proof is divided into two parts. Firstly it is proved that for any setpoint y_t , the optimization problem is recursively feasible. This means that the control law is defined throughout the evolution of the system. In the second part, asymptotic stability of the optimal equilibrium point (x_s^*, u_s^*) is proved.

Before proceeding with the proof of the theorem, the following lemma must be introduced.

Lemma 1: Consider system (1) subject to constraints (2). Suppose that Assumptions 1, 2 and 3 hold. Consider a given setpoint y_t and assume that for a given state x the optimal solution to $P_{N_c, N_p}(x, y_t)$ is such that $x = x_s^0(x, y_t) = g_x(y_s^0(x, y_t))$. Then $V_{N_c, N_p}^0(x, y_t) = V_O(y_s^* - y_t)$.

Proof:

Consider that the optimal solution to problem $P_{N_c, N_p}(x, y_t)$ is $(x_s^0, u_s^0, y_s^0)^1$. Since $x = x_s^0$, the optimal value cost function is

$$V_{N_c, N_p}^0(x, y_t) = V_O(y_s^0 - y_t).$$

The lemma will be proved by contradiction. Assume that $V_O(y_s^0 - y_t) > V_O(y_s^* - y_t)$, then since y_s^* is the unique minimizer of $V_O(\cdot)$, $y_s^0 \neq y_s^*$.

Define \hat{y}_s as

$$\hat{y}_s = \beta y_s^0 + (1 - \beta) y_s^* \quad \beta \in [0, 1].$$

From the definition of set \mathcal{Y}_t , it is clear that $(x_s^0, u_s^0) \in \hat{\mathcal{Z}}$ and hence it is in the interior of \mathcal{Z} . Therefore, there exists a $\hat{\beta} \in [0, 1)$ such that for \hat{y}_s given by a $\beta \in [\hat{\beta}, 1]$ the sequence of inputs \hat{u} generated by the terminal control law is such that (\hat{u}, \hat{y}_s) is a feasible solution of $P_{N_c, N_p}(x_s^0, y_t)$.

From the Lipschitz continuity of the function $g_x(\cdot)$ we have that $|x_s^0 - \hat{x}_s| \leq L_g |y_s^0 - \hat{y}_s|$, where $L_g > 0$ is the Lipschitz constant of $g_x(\cdot)$. Taking into account that $(y_s^0 - \hat{y}_s) = (1 -$

¹In this proof, the dependence of the optimal solution from (x, y_t) will be omitted for the sake of clarity. Also, recall that, from (7), $x_s^0 = g_x(y_s^0)$, and $u_s^0 = g_u(y_s^0)$.

$\beta)(y_s^0 - y_s^*)$ and the optimality of the solution, the following holds

$$\begin{aligned}
V_O(y_s^0 - y_t) &= V_{N_c, N_p}^0(x_s^0, y_t) \\
&\leq V_{N_c, N_p}(x_s^0, y_t; \hat{\mathbf{u}}, \hat{y}_s) \\
&= \sum_{j=0}^{N_p-1} \ell((x(j) - \hat{x}_s), (\kappa(x(j), \hat{y}_s) - \hat{u}_s)) \\
&\quad + V_f(x(N_p) - \hat{x}_s, \hat{y}_s) + V_O(\hat{y}_s - y_t) \\
&\leq V_f(x_s^0 - \hat{x}_s, \hat{y}_s) + V_O(\hat{y}_s - y_t) \\
&\leq b|x_s^0 - \hat{x}_s|^\sigma + V_O(\hat{y}_s - y_t) \\
&\leq b(L_g|y_s^0 - \hat{y}_s|)^\sigma + V_O(\hat{y}_s - y_t) \\
&= L_g^\sigma b(1 - \beta)^\sigma |y_s^0 - y_s^*|^\sigma + V_O(\hat{y}_s - y_t). \quad (15)
\end{aligned}$$

From the convexity of $V_O(\cdot)$ we have that

$$V_O(\hat{y}_s - y_t) \leq \beta V_O(y_s^0 - y_t) + (1 - \beta)V_O(y_s^* - y_t).$$

Therefore, we derive that

$$\begin{aligned}
V_O(y_s^0 - y_t) &\leq L_g^\sigma b(1 - \beta)^\sigma |y_s^0 - y_s^*|^\sigma \\
&\quad \beta V_O(y_s^0 - y_t) + (1 - \beta)V_O(y_s^* - y_t),
\end{aligned}$$

which leads to the following inequality

$$V_O(y_s^0 - y_t) - V_O(y_s^* - y_t) \leq L_g^\sigma b(1 - \beta)^{\sigma-1} |y_s^0 - y_s^*|^\sigma.$$

Since $\sigma > 1$, taking the limit of both sides of the inequality as β approaches 1 from the right we have that

$$\begin{aligned}
V_O(y_s^0 - y_t) - V_O(y_s^* - y_t) &\leq \lim_{\beta \rightarrow 1^-} L_g^\sigma b(1 - \beta)^{\sigma-1} |y_s^0 - y_s^*|^\sigma \\
&= 0.
\end{aligned}$$

Since we assumed that $V_O(y_s^0 - y_t) - V_O(y_s^* - y_t) > 0$, then the last inequality leads to a contradiction that proves the result. \blacksquare

Next, the theorem is proved. In order to simplify the notation throughout this proof, the optimal solution of $P_{N_c, N_p}(x, y_t)$ will be denoted as (\mathbf{u}^0, y_s^0) , i.e. omitting the dependence of (x, y_t) .

Recursive feasibility:

Consider that $x \in \mathcal{X}_{N_c, N_p}$ and (\mathbf{u}^0, y_s^0) denotes the optimal solution of $P_{N_c, N_p}(x, y_t)$. The resultant optimal state sequence is

$$\mathbf{x}^0 = (x^0(0), x^0(1), \dots, x^0(N_p)),$$

where $x^0(0) = x$ and $(x^0(N_p), y_s^0) \in \Gamma$.

As standard in MPC [27], [30], let us define the successor state, $x^+ = f(x, \kappa_{N_c, N_p}(x, y_t))$ and let us define also the following sequences:

$$\begin{aligned}
\tilde{\mathbf{u}}^+ &= (u^0(1), \dots, u^0(N_c - 1), \\
&\quad \kappa(x^0(N_c), y_s^0), \dots, \kappa(x^0(N_p), y_s^0)), \\
\tilde{y}_s^+ &= y_s^0.
\end{aligned}$$

The predicted sequence of states for x^+ and $(\tilde{\mathbf{u}}^+, \tilde{y}_s^+)$ is

$$\tilde{\mathbf{x}}^+ = (x^0(1), \dots, x^0(N_p), x^+(N_p))$$

where $x^+(N_p) = f(x^0(N_p), \kappa(x^0(N_p), y_s^0(x, y_t)))$. Since $(x^0(N_p), y_s^0(x, y_t)) \in \Gamma$, then $(x^+(N_p), y_s^0(x, y_t)) \in \Gamma$.

Therefore, given that $x^0(1) = x^+$, $(\tilde{\mathbf{u}}^+, \tilde{y}_s^+)$ is a feasible solution for the optimization problem $P_{N_c, N_p}(x^+, y_t)$ and consequently, the set \mathcal{X}_{N_c, N_p} is an admissible positive invariant set for the closed-loop system and hence the control law is well-defined and the constraints are fulfilled throughout the system evolution.

Asymptotic stability:

This property will be proved by showing that (x_s^*, u_s^*) is a stable equilibrium point of the closed-loop system, and next, that it is attractive.

Stability of $x_s^* = g_x(y_s^*)$ and $u_s^* = g_u(y_s^*)$ will be demonstrated by showing that the function

$$W(x, y_t) = V_{N_c, N_p}^0(x, y_t) - V_O(y_s^* - y_t) \quad (16)$$

is a Lyapunov function for the closed-loop system in a neighborhood of the equilibrium point.

Assume that ϵ is sufficiently small to guarantee that the terminal control law $u = \kappa(x, y_s^*)$ is admissible for all $|x - x_s^*| \leq \epsilon$. Next it is proved that there exists a pair of suitable \mathcal{K}_∞ functions, α_W and β_W , such that

$$\alpha_W(|x - x_s^*|) \leq W(x, y_t) \leq \beta_W(|x - x_s^*|)$$

- From Assumption 2 and the Lipschitz continuity of $g_x(\cdot)$ we infer that

$$\begin{aligned}
W(x, y_t) &\geq \ell(x - x_s^0, u - u_s^0) + V_O(y_s^0 - y_t) \\
&\quad - V_O(y_s^* - y_t) \\
&\geq \alpha_l(|x - x_s^0|) + \alpha_O(|y_s^0 - y_s^*|) \\
&\geq \alpha_l(|x - x_s^0|) + \alpha_O(L_g^{-1}|x_s^0 - x_s^*|) \\
&\geq \alpha_l(|x - x_s^0|) + \hat{\alpha}_O(|x_s^0 - x_s^*|),
\end{aligned}$$

where $\hat{\alpha}_O(s) = \alpha_O(s/L_g)$ is a \mathcal{K}_∞ function. Then, there exists a \mathcal{K}_∞ function α_W such that

$$\begin{aligned}
W(x, y_t) &\geq \alpha_W(|x - x_s^0| + |x_s^0 - x_s^*|) \\
&\geq \alpha_W(|x - x_s^*|).
\end{aligned}$$

Notice that this property holds for all feasible x .

- Let \mathbf{u}_κ be the sequence of future inputs derived from the local control law taking x as initial state and y_s^* as reference. Then this sequence will be feasible and

$$\begin{aligned}
V_{N_c, N_p}^0(x, y_t) &\leq V_{N_c, N_p}(x, y_t; \mathbf{u}_\kappa, y_s^*) \\
&\leq V_f(x - x_s^*, y_s^*) + V_O(y_s^* - y_t).
\end{aligned}$$

From this and due to the Assumption 3, we have that

$$W(x, y_t) \leq V_f(x - x_s^*, y_s^*) \leq b|x - x_s^*|^\sigma = \beta_W(|x - x_s^*|).$$

Next, it is proved that $W(x(k), y_t)$ is decreasing if $x(k) \neq x_s^*(x(k), y_t)$. To this aim, define $V_{N_c, N_p}(x^+, y_t; \tilde{\mathbf{u}}^+, y_s^0)$ as the cost function evaluated at the feasible solution $(\tilde{\mathbf{u}}^+, y_s^0)$, then,

taking into account the properties of the feasible nominal trajectories for x^+ , Assumption 3 and using standard procedures in MPC [27], [30] it is possible to obtain:

$$\begin{aligned}\Delta W(x, y_t) &= W(x^+, y_t) - W(x, y_t) \\ &= V_{N_c, N_p}^0(x^+, y_t) - V_{N_c, N_p}^0(x, y_t) \\ &\leq \tilde{V}_{N_c, N_p}(x^+, y_t; \tilde{\mathbf{u}}^+, y_s^0) - V_{N_c, N_p}^0(x, y_t) \\ &= -\ell((x - x_s^0), (u^0(0) - u_s^0)) \\ &\quad - V_f(x^0(N_p) - x_s^0, y_s^0) - V_O(y_s^0 - y_t) \\ &\quad + \ell((x(N_p) - x_s^0), (\kappa(x, y_s^0) - u_s^0)) \\ &\quad + V_f(f(x^0(N_p), \kappa(x, y_s^0), y_s^0) - x_s^0) \\ &\quad + V_O(y_s^0 - y_t),\end{aligned}$$

where $x^0(i)$, $u^0(i)$, x_s^0 , u_s^0 and y_s^0 denote $x^0(i)$, $u^0(i)$, $x_s^0(x, y_t)$, $u_s^0(x, y_t)$ and $y_s^0(x, y_t)$ respectively.

Given the definition of $V_f(\cdot)$ from Assumption 3 and considering Assumption 2 we have that

$$\begin{aligned}\Delta W(x, y_t) &\leq -\ell((x - x_s^0), (u^0(0) - u_s^0)) \\ &\leq -\alpha_\ell(|x - x_s^0|).\end{aligned}$$

Then $W(x, y_t)$ is a Lyapunov function for the closed-loop system and the stability is proved.

In order to prove asymptotic stability, it suffices to demonstrate convergence to (x_s^*, u_s^*) . To this aim, see that the inequality

$$W(x(k+1), y_t) - W(x(k), y_t) \leq -\alpha_\ell(|x(k) - x_s^0(x(k), y_t)|)$$

leads to state that

$$\lim_{k \rightarrow \infty} |x(k) - x_s^0(x(k), y_t)| = 0.$$

Given that $W(x(k), y_t) \geq 0$, then

$$\lim_{k \rightarrow \infty} W(x(k), y_t) = W_\infty.$$

From Lemma 1, we have that if $|x - x_s^0(x, y_t)| = 0$, then $W(x, y_t) = 0$. Therefore, since $\lim_{k \rightarrow \infty} |x(k) - x_s^0(x(k), y_t)| = 0$, we have that

$$\lim_{k \rightarrow \infty} W(x(k), y_t) = W_\infty = 0.$$

Taking into account the bounds of function $W(\cdot)$, this is equivalent to

$$\lim_{k \rightarrow \infty} \alpha_W(|x(k) - x_s^*|) \leq \lim_{k \rightarrow \infty} W(x(k), y_t) = 0$$

and then

$$\lim_{k \rightarrow \infty} |x(k) - x_s^*| = 0.$$

Thus, the proof is complete.

B. Proof of Theorem 2

This proof is derived from the proof of Theorem 1, although some technical details must be solved. Lemma 1 is adapted to this case as follows:

Lemma 2: Consider system (1) subject to constraints (2). Consider that Assumptions 2 and 4 hold. Consider a given setpoint y_t and assume that $N \geq n$ and that for a given state x

the optimal solution of $P_N(x, y_t)$ is such that $x = x_s^0(x, y_t) = g_x(y_s^0(x, y_t))$. Then $V_{N_c, N_p}^0(x, y_t) = V_O(y_s^* - y_t)$.

Proof:

The proof is similar to the proof of Lemma 1 if the inequality (15) is derived for the equality constraint case.

From the definition of the set \mathcal{Y}_t , it is clear that $(x_s^0, u_s^0) \in \hat{\mathcal{Z}}$ and hence it lays in the interior of \mathcal{Z} . From this fact and from the continuity of the model function, it can be derived that there exists a constant ϵ_1 such that for all sequences of control inputs $\hat{\mathbf{u}}$ satisfying $|\hat{u}(i) - u_s^0| \leq \epsilon_1$, the predicted trajectory and the input $(\phi(i; x_s^0, \hat{\mathbf{u}}), \hat{u}(i)) \in \mathcal{Z}$, for all $i = 0, \dots, N-1$.

From Assumption 4, in virtue of the inverse function theorem, for a prediction horizon $N \geq n$ there exists a $\delta_1(\epsilon_1)$ such that for all \bar{x} satisfying $|\bar{x} - x_s^0| \leq \delta_1$, there exists a $\hat{\mathbf{u}}$ such that $|\hat{u}(i) - u_s^0| \leq \epsilon_1$, for all $i = 0, \dots, N-1$, and $\phi(N; x_s^0, \hat{\mathbf{u}}) = \bar{x}$. From the continuity of $g_x(\cdot)$, it can be derived that there exists a neighborhood of y_s , $\hat{\mathcal{Y}}_t(y_s)$ such that for every $\hat{y}_s \in \hat{\mathcal{Y}}_t(y_s)$ there exists a sequence of inputs $\hat{\mathbf{u}}$ such that $|\hat{u}(i) - u_s^0| \leq \epsilon_1$, for all $i = 0, \dots, N-1$, and $\phi(N; x_s^0, \hat{\mathbf{u}}) = g_x(\hat{y}_s)$.

In virtue of the last two claims, it can be stated that there exists a equilibrium point $(\hat{x}_s, \hat{u}_s, \hat{y}_s)$ with $\hat{y}_s \in \hat{\mathcal{Y}}_t(y_s)$ and a sequence $\hat{\mathbf{u}}$ such that $|\hat{u}(i) - u_s^0| \leq \epsilon_1$, $\phi(N; x_s^0, \hat{\mathbf{u}}) = \hat{x}_s$ and $(\phi(i; x_s^0, \hat{\mathbf{u}}), \hat{u}(i)) \in \mathcal{Z}$ for all $i = 0, \dots, N-1$. That is, $(\hat{\mathbf{u}}, \hat{y}_s)$ is a feasible solution of $P_N(x_s^0, y_t)$.

From the controllability Assumption 4, if the pair $(\hat{\mathbf{u}}, \hat{y}_s)$ is chosen in such a way that $|\hat{u}(i) - u_s^0| \leq \epsilon_u/2$, $|\hat{x}_s - x_s^0| \leq \epsilon_x$ and $|\hat{u}_s - u_s^0| \leq \epsilon_u/2$ we have that $|\hat{u}(i) - \hat{u}_s| \leq \epsilon_u$ and $|\hat{x}_s - x_s^0| \leq \epsilon_x$, and then,

$$\begin{aligned}V_N(x_s^0, y_t; \hat{\mathbf{u}}, \hat{y}_s) &= \sum_{i=0}^{N-1} \ell(\hat{x}(i) - \hat{x}_s, \hat{u}(i) - \hat{u}_s) \\ &\quad + V_O(\hat{y}_s - y_t) \\ &\leq b|x_s^0 - \hat{x}_s|^\sigma + V_O(\hat{y}_s - y_t).\end{aligned}$$

Taking into account the last inequality, the Lipschitz continuity of the function g_x , and optimality of the solution, the following holds

$$\begin{aligned}V_N^0(x_s^0, y_t) &= V_O(y_s^0 - y_t) \\ &\leq V_N(x_s^0, y_t; \hat{\mathbf{u}}, \hat{y}_s) \\ &\leq b|x_s^0 - \hat{x}_s|^\sigma + V_O(\hat{y}_s - y_t) \\ &\leq bL_g^\sigma |y_s^0 - \hat{y}_s|^\sigma + V_O(\hat{y}_s - y_t) \\ &\leq bL_g^\sigma (1 - \beta)^\sigma |y_s^0 - y_s^*|^\sigma + V_O(\hat{y}_s - y_t),\end{aligned}$$

where L_g is the Lipschitz constant of $g_x(\cdot)$. Thus, inequality (15) is derived. ■

Recursive feasibility property is derived from the proof of Theorem 1 and in order to derive the asymptotic stability property it suffices to prove the existence of the upperbound of $W(\cdot)$.

Assume that ϵ is sufficiently small to guarantee that Assumption 4 holds and $P_N(x, y_t)$ is feasible for $y_s = y_s^*$ and for all x such that $|x - x_s^*| \leq \epsilon$. Let $(\tilde{\mathbf{u}}, y_s^*)$ be a feasible solution of $P_N(x, y_t)$, then

$$V_N^0(x, y_t) \leq \sum_{i=0}^{N-1} \ell(x(i) - x_s^*, u(i) - u_s^*) + V_O(y_s^* - y_t).$$

Due to the controllability of x_s^* (Assumption 2), there exists a \mathcal{K}_∞ function β_W such that

$$\begin{aligned} W(x, y_t) &= V_N^0(x, y_t) - V_O(y_s^* - y_t) \\ &\leq \sum_{i=0}^{N-1} \ell(x(i) - x_s^*, u(i) - u_s^*) \\ &\leq \beta_W(|x - x_s^*|). \end{aligned}$$

C. Proof of Theorem 3

This proof requires firstly the demonstration of some lemmas and properties.

Lemma 3: Consider that the assumptions of Theorem 1 hold. Let $x^{\gamma,0}(j; x, y_t)$ be the optimal trajectory solution to the optimization problem $P_{N_c, N_p}^\gamma(x, y_t)$ for any $\gamma \geq 1$.

If $(x^{\gamma,0}(N_p; x, y_t), y_s^{\gamma,0}) \notin \Gamma_\alpha$, then $(x^{\gamma,0}(j; x, y_t), y_s^{\gamma,0}) \notin \Gamma_\alpha$ for all $j = 0, \dots, N_p$.

Proof: This is proved by contradiction. Assume that there exists an i such that $(x^{\gamma,0}(i; x, y_t), y_s^{\gamma,0}) \in \Gamma_\alpha$ and $(x^{\gamma,0}(N_p; x, y_t), y_s^{\gamma,0}) \notin \Gamma_\alpha$.

If $i < N_c$, then a suboptimal solution can be derived by taking the optimal control inputs until prediction i and then taking the terminal control law (similarly to Lemma 1 in [20]) while the artificial reference is maintained. This ensures that the suboptimal predicted trajectory is identical to the optimal one until prediction i and then it remains in Γ_α . For the sake of clarity the dependence on (x, y_t) will be removed and thus, the optimal predicted states and inputs will be denoted by $x^{\gamma,0}(j)$ and $u^{\gamma,0}(j)$ respectively, and the suboptimal predicted states and inputs will be denoted by $x^\gamma(j)$ and $u^\gamma(j)$ respectively.

Then we have that

$$\begin{aligned} V_{N_c, N_p}^{\gamma,0}(x, y_t) &\geq \sum_{j=0}^{i-1} \ell(x^{\gamma,0}(j), u^{\gamma,0}(j)) \\ &\quad + V_f(x^{\gamma,0}(N_p)) + V_O(y_s^{\gamma,0} - y_t). \end{aligned}$$

On the other hand, in virtue of Assumption 3 and the properties of the terminal cost function, we have that the cost of the suboptimal solution satisfies the following inequality

$$\begin{aligned} V_{N_c, N_p}^\gamma(x, y_t) &\leq \sum_{j=0}^{i-1} \ell(x^{\gamma,0}(j), u^{\gamma,0}(j)) \\ &\quad + V_f(x^{\gamma,0}(i)) + V_O(y_s^{\gamma,0} - y_t). \end{aligned}$$

From the optimality of the solution, it is clear that

$$V_{N_c, N_p}^{\gamma,0}(x, y_t) \leq V_{N_c, N_p}^\gamma(x, y_t)$$

From this inequality it is derived that

$$V_f(x^{\gamma,0}(N_p)) \leq V_f(x^{\gamma,0}(i)) \leq \alpha.$$

This implies that $x^{\gamma,0}(N_p; x, y_t) \in \Gamma_\alpha$, which is a contradiction that proves the statement.

If $i > N_c$, then fact that Γ_α is a positive invariant for the system controlled by the terminal control law implies that $x^{\gamma,0}(j; x, y_t) \in \Gamma_\alpha$ for all $j \geq i$, leading again to a contradiction. ■

Lemma 4: Consider that the assumptions of Theorem 1 hold. Let $d = \alpha_\ell(\beta_f^{-1}(\alpha))$, then

$$\ell(x - g_x(y_s), u - g_u(y_s)) \geq d$$

for all $(x, y_s) \notin \Gamma_\alpha$.

Proof: Denote $x_s = g_x(y_s)$ and $u_s = g_u(y_s)$. Assume that

$$\ell(x - x_s, u - u_s) \leq d = \alpha_\ell(\beta_f^{-1}(\alpha)).$$

Then we have that $|x - x_s| \leq \beta_f^{-1}(\alpha)$ which implies that $\beta_f(|x - x_s|) \leq \alpha$. Therefore, $V_f(x - x_s, y_s) \leq \alpha$ and then $x \in \Gamma_\alpha$.

This leads to prove that if $x \notin \Gamma_\alpha$ then $\ell(x - x_s, u - u_s) > d$. ■

Recursive feasibility:

The optimization problem is recursively feasible if for any $x \in \hat{\Upsilon}_{N_p, \gamma}(y_t)$, then $x^+ \in \hat{\Upsilon}_{N_p, \gamma}(y_t)$. From Lemma 3 it is inferred that if the terminal region is not reached in N_p steps, then all the trajectory of the system is out of Γ_α and hence

$$\begin{aligned} V_{N_c, N_p}^{\gamma,0}(x, y_t) &> N_p d + \gamma \alpha + V_O(y_s^{\gamma,0} - y_t) \\ &\geq N_p d + \gamma \alpha + V_O(y_s^* - y_t), \end{aligned}$$

which implies that $x \notin \Upsilon_{N_p, \gamma}(y_t)$ leading to a contradiction. Therefore for any $x \in \hat{\Upsilon}_{N_p, \gamma}(y_t)$, the optimal solution of $P_{N_c, N_p}^\gamma(x, y_t)$ is such that $(x^{\gamma,0}(N_p), y_s^{\gamma,0}) \in \Gamma_\alpha$

Defining

$$W(x, y_t) = V_{N_c, N_p}^{\gamma,0}(x, y_t) - V_O(y_s^* - y_t)$$

from the proof of Theorem 1 we have that

$$W(x^{\gamma,0}(1; x, y_t), y_t) \leq W(x, y_t) \leq N_p d + \gamma \alpha.$$

Since $x^+ = x^{\gamma,0}(1; x, y_t)$, we derive that $x^+ \in \Upsilon_{N_p, \gamma}(y_t)$.

Asymptotic stability

Since for all $x \in \Upsilon_{N_p, \gamma}(y_t)$, the terminal constraint is satisfied, the asymptotic stability property directly yields following the same arguments as in the proof to Theorem 1.

D. Proof of Property 2

- (i) Let $x \in X_{N_c}$, then any feasible solution (\hat{u}, \hat{y}_s) of the problem with terminal equality constraint is also a feasible solution of the problem with terminal inequality constraint. This solution ensures that

$$V_{N_c, N_p}^{\gamma_0,0}(x, y_t) \leq V_{N_c, N_p}^{\gamma_0}(x, y_t; \hat{u}, \hat{y}_s) \leq N_c D + \hat{V}_O$$

and then $V_{N_c, N_p}^{\gamma_0,0}(x, y_t) - V_O(y_s^* - y_t) \leq N_c D + \hat{V}_O$.

Since γ_0 is such that $N_c D + \hat{V}_O = N_p d + \gamma_0 \alpha$, then $x \in \Upsilon_{N_p, \gamma_0}(y_t)$.

- (ii) Assume that x is in the domain of attraction of the MPC for tracking with $\Gamma_{\rho\alpha}$ as terminal constraint set and consider that (\hat{u}, \hat{y}_s) a feasible solution. Then

$$V_{N_c}^{\gamma,0}(x, y_t) \leq V_{N_c}^{\gamma,0}(x, y_t; \hat{u}, \hat{y}_s) \leq N_c D + \hat{V}_O + \gamma \rho \alpha.$$

From the definition of ρ and γ_0 we have that $\rho\gamma = \gamma - \gamma_0$ and recalling that $\gamma_0\alpha = N_c D - N_c d + \hat{V}_O$, the following equality holds

$$N_c D + \hat{V}_O + \gamma\alpha - \gamma_0\alpha \leq N_c d + \gamma\alpha.$$

Therefore, $x \in \Upsilon_{N_c, \gamma}(y_t)$ and the property is proved.

E. Proof of Property 3

Define problem $P_{N_c, N_p, \mu}^r(x, y_t)$ the optimization problem (9) taking $\mu|y_s - y_t|$ as offset cost function. Then, problem $P_{N_c, N_p, \mu}^r(x, y_t)$ results from problem $P_{N_c, N_p}^r(x, y_t)$ with the last constraint posed as an exact penalty function [23]. Therefore, there exists a finite constant $\mu^* > 0$ such that for all $\mu \geq \mu^*$, $V_{N_c, N_p, \mu}^{r, 0}(x, y_t) = V_{N_c, N_p}^{r, 0}(x, y_t)$ for all $x \in \mathcal{X}_N^r(y_t)$ [23], [5].

Consider now, problem $P_{N_c, N_p}(x, y_t)$ with

$$V_O(y_s - y_t) \geq \mu^*|y_s - y_t|.$$

Since the optimal solution of the MPC for regulation is a feasible solution of the MPC for tracking we have that $V_{N_c, N_p}^0(x, y_t) \leq V_{N_c, N_p}^{r, 0}(x, y_t)$. On the other hand, since $V_O(y_s - y_t) \geq \mu^*|y_s - y_t|$ we infer that $V_{N_c, N_p}^0(x, y_t) \geq V_{N_c, N_p, \mu^*}^{r, 0}(x, y_t) = V_{N_c, N_p}^{r, 0}(x, y_t)$. Then, we can state that $V_{N_c, N_p}^0(x, y_t) = V_{N_c, N_p}^{r, 0}(x, y_t)$ for all $x \in \mathcal{X}_{N_c, N_p}^r(y_t)$, and from the uniqueness of the solution of $P_{N_c, N_p}(x, y_t)$, we have that $k_{N_c, N_p}(x, y_t) = k_{N_c, N_p}^r(x, y_t)$.

APPENDIX B

CALCULATION OF THE TERMINAL INGREDIENTS

The presented method exploits the LTV modeling technique and the partition method proposed in [32], [33]. In this section, for the sake of simplicity, it is considered that $\mathcal{Z} = \mathcal{X} \times \mathcal{U}$ and that the stage cost function is $\ell(z, v) = z'Qz + v'Rv$.

Firstly, the set of feasible setpoints \mathcal{Y}_t is split in a partition, i.e. a collection of disjoint sets $\{\mathcal{Y}_{s_i}\}$ such that $\bigcup_i \mathcal{Y}_{s_i} = \mathcal{Y}_t$.

For each set \mathcal{Y}_{s_i} , choose the positive constants $\varepsilon_{x_i}, \varepsilon_{u_i}$ and define

$$\mathcal{X}_i = \bigcup_{y_s \in \mathcal{Y}_{s_i}} g_x(y_s) \oplus \mathcal{B}_n(\varepsilon_{x_i}), \quad \mathcal{U}_i = \bigcup_{y_s \in \mathcal{Y}_{s_i}} g_u(y_s) \oplus \mathcal{B}_m(\varepsilon_{u_i}).$$

The constants ε_{x_i} and ε_{u_i} are chosen in such a way that for all $x \in \mathcal{X}_i$, $u \in \mathcal{U}_i$ and $y_s \in \mathcal{Y}_{s_i}$, the nonlinear dynamic model (1) can be described as an LTV given by:

$$f(x, u) = f(x_s(y_s), u_s(y_s)) \quad (17)$$

$$+ \sum_{j=1}^{n_i} \lambda_j [A_{ij}(x - g_x(y_s)) + B_{ij}(u - g_u(y_s))], \quad (18)$$

where $[A_{ij} \ B_{ij}] \in \{[A_{i1} \ B_{i1}], \dots, [A_{in_i} \ B_{in_i}]\}$, $\lambda_j \in [0, 1]$ and $\sum_{j=1}^{n_i} \lambda_j = 1$. Since the parameters λ_j depend on x , u , and y_s , they might vary throughout the evolution of the system. Besides, there must exist a suitable control gain $K_i \in \mathbb{R}^{m \times n}$ and a Lyapunov matrix $P_i \in \mathbb{R}^{n \times n}$ such that

$$A'_{K_{ij}} P_i A_{K_{ij}} - P_i \leq -Q - K'_i R K_i$$

for all j , where $A_{K_{ij}} = A_{ij} + B_{ij}K_i$.

Notice that if the matrices of the linearized system at the equilibrium point given by y_s , $A(g_x(y_s), g_u(y_s))$ and $B(g_x(y_s), g_u(y_s))$, are controllable then, by continuity, there exists a pair of values ε_{x_i} and ε_{u_i} such that the latter condition holds.

Then define the set $\mathcal{Z}_{K_i} = \{z : z \in \mathcal{B}_n(\varepsilon_{x_i}), K_i z \in \mathcal{B}_m(\varepsilon_{u_i})\}$ and let Ω_i be an invariant set contained in \mathcal{Z}_{K_i} for the LTV given by

$$z^+ = \sum_{j=1}^{n_i} \delta_j A_{K_{ij}} z,$$

where $\delta_j \in [0, 1]$ and $\sum_{j=1}^{n_i} \delta_j = 1$.

Then, $\forall y_s \in \mathcal{Y}_{s_i}$ and $x_0 \in g_x(y_s) \oplus \Omega_i$, the evolution of the system

$$\begin{aligned} x(k+1) &= f(x(k), u(k)) \\ u(k) &= K_i(x(k) - g_x(y_s)) + g_u(y_s) \end{aligned}$$

ensures that $x(k) \in g_x(y_s) \oplus \Omega_i \subseteq \mathcal{X}_i \subseteq \mathcal{X}$ and $u(k) \in \mathcal{U}_i \subseteq \mathcal{U}$. Therefore, it is derived that

$$\begin{aligned} \Gamma_i &= \{(x, y_s) : x \in g_x(y_s) \oplus \Omega_i, y_s \in \mathcal{Y}_{s_i}\} \\ &= \left(\bigcup_{y_s \in \mathcal{Y}_{s_i}} g_x(y_s) \oplus \Omega_i \right) \times \mathcal{Y}_{s_i} \end{aligned}$$

is such that $\forall (x_0, y_s) \in \Gamma_i$, $(x(k), y_s) \in \Gamma_i \subseteq \mathcal{X}_i$, $u(k) \in \mathcal{U}_i$. Then Γ_i is an admissible invariant set for tracking and

$$\begin{aligned} V_{f_i}(x - g_x(y_s), y_s) &= (x - g_x(y_s))' P_i (x - g_x(y_s)) \\ \kappa(x, y_s) &= K_i(x - g_x(y_s)) + g_u(y_s) \end{aligned}$$

are a suitable terminal cost function and terminal control law respectively $\forall y_s \in \mathcal{Y}_{s_i}$.

Hence the terminal ingredients are:

$$\begin{aligned} \Gamma &= \{(x, y_s) : y_s \in \mathcal{Y}_{s_i}, (x, y_s) \in \Gamma_i\} \\ V_f(\bar{x}, y_s) &= V_{f_i}(\bar{x}, y_s) \quad \text{where } i : y_s \in \mathcal{Y}_{s_i}. \end{aligned}$$

Remark 8: A drawback of this approach is that the size of Ω_i could be very small. However, taking $N_p > N_c$ the domain of attraction of the controller can be enlarged [24].

Daniel Limon received the M. Eng. and Ph.D. degrees in electrical engineering from University of Seville, Seville, Spain, in 1996 and 2002 respectively. From 1999 to 2007, he was Assistant Professor in the Departamento de Ingeniería de Sistemas y Automática, University of Seville, from 2007 to 2017 Associate Professor and since 2017 Full Professor in the same department. He is the author or coauthor of more than 120 publications including book chapters, journal papers, conference proceedings and educational books. His current research interests include Model Predictive Control, stability analysis, control of constrained systems, robust control, process control, economic process control and trajectory tracking control. Dr. Limon was Keynote Speaker at the International Workshop on Assessment and Future Directions of Nonlinear Model Predictive Control in 2008 and Semiplenary Lecturer at the IFAC Conference on Nonlinear Model Predictive Control in 2012 (NMPC'12). He has been the Chair of the 5th IFAC Conference on Nonlinear Model Predictive Control (NMPC'15). He has co-funded the spin off company Optimal Performance (University of Seville, Spain).

Antonio Ferramosca was born in Maglie (LE), Italy, in 1982. He received the degree in Computer Science Engineering from the University of Pavia (Italy) in 2006, and the Ph.D. degree in Automation, Robotics and Telematics, with full marks and honors (summa cum laude), from the University of Seville (Spain) in 2011. He is currently Associate Researcher at the Argentinean National Scientific and Technical Research Council (CONICET). He was a visiting researcher at the University of Wisconsin-Madison (USA) in 2009, at the Institute of Technological Development for the Chemical Industry (IN-TEC), Santa Fe (Argentina) in 2010, and at the University of Seville (Spain) in 2015. He is author and co-author of more than 60 publications including book chapters, journal papers, conference papers and industrial deliverables. His research interests include Model Predictive Control, nonlinear systems, impulsive systems, distributed control, stability, control of biological systems, and robust control.

Ignacio Alvarado was born in Seville, Spain, in 1972. He received his M.Eng. degree in Electrical Engineering from the University of Seville (Spain) in 2002, and his European Ph.D. degree with full marks and honors (summa cum laude) from the same University, in 2007. From 2003 to 2006, he was a research assistant at the University of Seville. From September 2004 to September 2005, he was a visiting researcher at the Institute for Systems Theory in Engineering, University of Stuttgart, Germany, funded by a CTS grant. He was also a visiting researcher at PSA (Solar plant of Almería), Almería, Spain in 2006. He is the author or co-author of more than 35 publications including book chapters, journal papers, and conference papers. Currently, he is assistant professor in the Department of Systems engineering and Automatics, University of Seville. His research interests include control theory, predictive control, tracking and robust predictive control.

Teodoro Alamo was born in Spain in 1968. He received his M.Eng. degree in Telecommunications Engineering from the Polytechnic University of Madrid (Spain) in 1993 and his PhD. in Telecommunications Engineering from the University of Seville in 1998. From 1993 to 2000 he was assistant professor of the Department of System Engineering and Automatic Control of the University of Seville. He was associate professor from 2001 to 2010. Since March 2010 he is full professor in the same Department. He was at the Ecole Nationale Supérieure des Télécommunications (Telecom Paris) from September 1991 to May 1993. Part of his PhD was done at RWTH Aachen, Alemania, June-September 1995. He is the author or coauthor of more than 160 publications including books, book chapters, journal papers, conference proceedings and educational books. (google scholar profile available at <http://scholar.google.es/citations?user=W3ZDTkIAAAAJ&hl=en>). His current research interests are in decision making, model predictive control, machine learning, randomized algorithms and optimization strategies. He has co-funded the spin off company Optimal Performance (University of Seville, Spain).