

Proving the climate benefit in the production of biofuels from municipal solid waste refuse in Europe

C. Aracil,^a P. Haro,^{*,a} J. Giuntoli^b and P. Ollero^a

^a *Bioenergy Group, Chemical and Environmental Engineering Department. Escuela Técnica Superior de Ingeniería, Universidad de Sevilla. Camino de los Descubrimientos s/n. 41092 Seville, Spain.*

^b *European Commission, Joint Research Centre (JRC), Institute for Energy and Transport (IET), Sustainable Transport Unit, Westerduinweg 3, 1755LE, Petten, The Netherlands.*

Abstract

The non-recyclable fraction of municipal solid waste (MSW refuse) represents over half of the total MSW production in Europe, with an energetic potential of 1,250 PJ/year, a similar quantity to the current potential for energy production from agricultural residues. Currently, there are no alternative uses for MSW refuse other than landfilling or incineration. Thus, it represents an important untapped resource for biofuel production in Europe. Standard attributional LCAs have not been able to capture some of the bioenergy interactions with the climate system and neither to properly assess the climate change mitigation potential of bioenergy technologies. This study aims to fill this gap and properly assess the impact of the production of biofuels from MSW refuse on climate change by applying several methodological improvements in a time-dependent assessment, i.e., an explicit consideration of biogenic carbon flows using a dynamic LCA and an absolute formulation of the cumulative and instantaneous climate metrics. Two diverging examples of current MSW management systems are selected as references against which to assess the potential climate benefit of biofuel production: with or without dominant landfill disposal and with high or low GHG emissions from the power generation sector. The results show that in countries with current negligible landfilling, the production of biofuels would lead to a clear climate benefit. For landfill-dominant countries, the climate benefit would only be temporarily achieved in the medium term as the impact of landfills on climate decreases in the long term. However, considering a progressive banning of landfilling promoted by other policies for environmental

protection and resource efficiency, the results would become positive for both countries with climate change mitigation guaranteed by using MSW refuse for biofuel production.

Keywords: bioenergy; climate change mitigation; dynamic LCA; municipal solid waste (MSW); emission reduction

1. Introduction

The impact of anthropogenic greenhouse gases (GHG) emissions on climate change is a subject of growing public concern. From 1972 to the present, numerous Climate Change Summits have joined scientists from nations around the world to analyse the increasing concentration of CO₂ in the atmosphere and its consequences on the climate. The Kyoto Protocol was the first international agreement aiming at curbing GHG emissions, but its implementation has been only partially successful. The first-ever universal, legally binding global climate post-Kyoto deal has been adopted in Paris in December 2015. This agreement relies on pledges from signatory countries to drastically reduce GHG emissions from transport and industry sectors by 2030 in order to maintain the temperature anomaly below 2 °C, or even 1.5 °C, compared to the pre-industrial period¹.

The International Energy Agency (IEA) stated that the world cannot emit more than around 1000 Gt of CO₂ from 2011 onwards in order to achieve a 2 °C target^{2,3}. According to the IEA *BLUE map scenario*, 3,000 Mtoe of biomass and waste (8% of the energy mix for 2050) will be demanded as primary energy to achieve this objective⁴. However, the IEA claims that, along with bioenergy production, it will also be crucial to incorporate negative-carbon technologies, such as biogenic carbon capture and storage (Bio-CCS)⁴. Bio-CCS is said to have a potential for carbon abatement ranging from 3 to 10 Gt of CO₂ equivalent per year according to Fifth Assessment Report of the International Panel of Climate Change (IPPC AR5)^{5,6}.

In Europe, the Renewable Energy Directive (RED) incentivises the production of bioenergy from different types of biomass sources allowing the EU Member States to support biofuels production, e.g. tax exemptions or quotas⁷. However, the use of food crops for biofuel production has created a controversy since GHG emissions linked to indirect land-use change have been shown to be significant, in many cases actually making biofuels more GHG intensive than fossil fuels^{8,9}. Consequently, the recent RED amendment imposes a cap on the use of food crops and clearly promotes the use of waste and residue feedstocks¹⁰. Nonetheless, potential environmental risks

associated to biofuels production from wastes and residues have been raised in the literature¹¹⁻¹⁸. Regarding GHG emissions, literature is still scarce¹¹⁻¹⁵.

Municipal Solid Waste (MSW) is one of the waste materials considered as a possible source for biofuels production in both the RED and the literature. The use of MSW in production processes is in agreement with the principles of the Circular Economy, where fossil fuel extraction and waste generation are their key drivers. MSW also compares favourably with other waste and residue feedstocks since it is available throughout the year, it is concentrated (supply locations), and it is costless or even a direct source of revenues due to the negative cost paid for its disposal, e.g. landfill gate fee^{19,20}. MSW is a heterogeneous mixture of different waste materials, such as food scraps, plastics, paper and cardboard, wood, textiles and inert materials. The composition of MSW depends on the waste management system, feeding habits and economic development of the region considered¹⁶. In accordance with the European waste hierarchy, only the non-recyclable fraction of MSW, called MSW refuse, can be directly used for energy recovery, including electricity and fuel production; while the use of other waste fractions must be justified by a life-cycle thinking²¹. The MSW refuse can be identified in Europe by the codes shown in Table S1 of the Supplementary Material (SM)²².

In 2013, 242 million tons of MSW were generated in Europe and the 57% of them, i.e., the MSW refuse, were incinerated or landfilled²³. Considering a lower heating value between 8 and 12 MJ/kg²⁴⁻²⁶, the MSW refuse generated in Europe would be equivalent to 1,250 PJ/year. Therefore, MSW refuse is an energy source similar to agricultural residues in Europe²⁷. However, as it has been proved for first generation biofuels (indirect land-use change)⁷, it is mandatory to avoid a shifting of environmental burdens if a change in MSW refuse management is going to be promoted.

Currently, MSW refuse is either disposed in landfills or incinerated, in both cases with partial energy recovery. However, the situation is not even throughout the continent. In Northern and Central Europe, MSW refuse is mainly incinerated with energy recovery in waste-to-energy plants and landfill disposal is limited or even banned whereas in Southern and Eastern Europe, the MSW refuse is mainly landfilled with partial biogas recovery and used for electricity production, and only to a lesser extent incinerated (Figure 1)²³.

Figure 1. Landfilling and incineration ratios of MSW refuse in Europe (elaborated from Eurostat²³).

In a thermochemical biorefinery producing biofuels from MSW refuse, the Refuse Derived Fuel (RDF) can be produced and processed with the same processing technologies used for the production of biofuels from lignocellulosic biomass: pyrolysis and gasification. Considering RDF, gasification offers a higher adaptability and versatility (it allows the co-production of fuels and electricity)^{12,13,28-29}. The main drawback is the technical limitations of syngas cleaning (e.g. removal of tars, heavy metals and inorganic compounds)^{30,31}. Another option is to consider a biochemical biorefinery for the production of biofuels from MSW refuse. The heterogeneity of MSW refuse and the high concentration of heavy metals make their biochemical conversion difficult^{32,33} and therefore, this option is not considered as feasible for biofuel production. However, biochemical conversion is usually associated to the organic sorted fraction of MSW^{33,34}.

2. Goal and scope of the study

Despite the support to MSW refuse for the production of biofuels, to the authors' knowledge, a comprehensive study analysing the actual climate benefit from the shift of MSW refuse management system in different European regions is still missing. This study aims to cover this gap by analysing the climate benefit in the production of biofuels from MSW refuse in Europe looking for possible climate burdens.

Firstly, the emissions associated to the different MSW refuse management alternatives (landfilling, incineration and production of biofuels) are assessed separately. Then, we calculate the GHG balance, saving and differential impact of biofuels production as indicated in our previous studies based on European regulation (static assessment). We analyse two EU member states (Spain and Sweden), considering two scenarios: one in which the current MSW management has been extended, unchanged, for the next 100 years, and one where it varies to follow EU Directives (phasing landfill disposal out) together with an evolution of emissions from the electricity mix and transportation fuels.

Because the release of GHG emissions in landfills is dynamic, time-dependent parameters are necessary to provide a complete impact assessment. We assess two combinations: the climate change mitigation potential of different MSW refuse management options and the climate change mitigation achievable in the two member states.

Finally, we test the sensitivity to the main parameters in the study, such as biofuel production efficiency, biogas collection efficiency in the landfill, fraction of carbon captured by Bio-CCS and biogenic fraction in the MSW refuse.

3. Materials and methods

The recent debate concerning the proper assessment of the climate impact of bioenergy has highlighted that attributional Life Cycle Assessment (LCA) studies can incur significant shortfalls³⁵. The latest LCA literature on bioenergy systems has seen the implementation of methodological improvements to provide a more complete impact assessment³⁶, which are used in this study.

Firstly, ignoring biogenic-CO₂ flows and considering biomass as inherently and instantaneously carbon neutral lead to erroneous results³⁶⁻³⁸. Consequently, two different approaches are followed for the modelling of biogenic GHG emissions. If the mitigation potential of alternative management options were aimed, starting feedstock and re-absorption would be the same for both the reference and the bioenergy system (cancelling out). In this case, all CO₂ emissions are counted, irrespective of their biogenic or fossil origin. If the climate change mitigation for different countries is aimed, the feedstock changes. In this second case, we have to exclude biogenic-CO₂ emissions from the model. This is equivalent to implicitly assume that either all the biomass in the MSW has an annual growth cycle or it has spent sufficient time in the products pool so that the original biomass plant has fully regrown. Figure 2 gives a summary of all carbon fluxes in the production of biofuels and current MSW refuse management.

Secondly, many studies and current European methodology calculate the climate mitigation potential of biofuels and bioenergy by comparing the supply chain impact of biofuels production with the supply chain impact of a fossil comparator. This is not appropriate since, besides the fossil comparator, the reference system should also include the current uses of the feedstock (in this case MSW refuse).

Finally, since biomass decomposition in the landfill is a dynamic process³⁹, a dynamic LCA assessment is also required. This is similar to what has been done for forest residues degradation^{37,40-42}). The standard, normalised characterisation factors applied in LCA analysis, Global Warming Potential (GWP 100), are not appropriate to capture these transient phenomena¹⁸. Therefore, firstly we apply the absolute formulation of the climate metric, Absolute Global Warming Potential (AGWP) to capture the dynamic trends. Secondly, we use two different

types of metric: i) the AGWP is a cumulative metric that relates to certain climate change impacts such as sea level rise; ii) the Absolute Global surface Temperature change Potential (AGTP), which is an instantaneous metric and more appropriate to represent climate impacts associated to the temperature anomaly, such as extreme weather events.

In this study, only Well Mixed GHG (WMGHG) including CO₂, CH₄ and N₂O are considered. However, Near Term Climate Forcers (NTCF) such as aerosols and ozone precursors may have an important influence on climate, although this often results in a net cooling. Since most of the NTCFs are also local, air pollutants and future strategies will likely limit their emissions. Consequently, by excluding their impact we are applying a conservative assumption for the production of biofuels from MSW refuse. Construction and dismantling of the thermochemical biorefinery and the ashes management from biofuel production and incineration are not included in the assessment and they are assumed to contribute equally for all regions in Europe. The modeling and calculation of the results is done using spreadsheets.

Figure 2. Carbon fluxes associated to the production of biofuels from MSW refuse (included in the bioenergy, BIO, system), the landfill disposal and the incineration with energy recovery (included in business as usual, BAU, system).

3.1. Definition of the bioenergy (BIO) and business as usual (BAU) systems

Two systems are defined in this study: the bioenergy system (BIO) and the business as usual system (BAU). Both systems are based on the same amount of MSW refuse and an equal amount of all products is generated (Figure 3). The business as usual system (BAU) includes the current management of MSW refuse through landfilling and/or incineration and the production of transportation fuels from fossil fuels. Both landfill and incineration options include energy recovery (via biogas combustion in an engine and a boiler respectively). However, only incineration provides heat for district heating if necessary (common practice in Northern Europe). In the bioenergy system, the MSW refuse is used to produce biofuels and electricity, and district heating if necessary (using waste heat from the biorefinery). Since there is a deficit of electricity compared to the amount produced in the BAU system, this has to be balanced from the electricity grid.

In the modelling of the BAU system, a fraction of the generated biogas leaves out contributing to climate change and the rest is used as fuel to generate electricity or burned in a flare. The guidelines for the assessment of the timing of GHG emissions have been provided by the IPCC⁴⁰. For incineration, however, the emissions are evenly produced, as well as in the thermochemical biorefinery. Further details are given in the SM.

3.2. Geographical scope of the assessment

In order to help decision-makers to analyse the environmental risks and benefits of biofuels production from MSW refuse, two extreme examples of current MSW management systems in Europe are assessed: Spain, where landfilling is dominant and incineration is below European average levels; and Sweden, where landfilling is negligible and incineration is dominant (Figure 4). In both Spanish and Swedish cases, the incorporation of Bio-CCS is assessed.

Table 1 shows the typical composition of the MSW refuse in Spain and Sweden. It can be seen that the content of biogenic carbon depends on the waste composition and the collection system, having Spanish MSW refuse a higher biogenic fraction than Sweden. Therefore, the biogenic content is, together with MSW management systems, an important parameter in the assessment.

Figure 3. Definition of the bioenergy and business as usual systems in the study. The same mix of fuels ($z_1=z_2$), electricity ($y_1+y_2=y_3+y_4$) and district heating ($x_1=x_2$) are produced in both systems. The x_i , y_i and z_i values represents the shares in LHV basis.

Figure 4. Typical management of unsorted waste in Europe along with the proposed production of biofuels in this study. The given values (mass basis “as received”) represent the Spanish and Swedish management systems respectively.

Table 1. Composition of MSW refuse in Spain and Sweden in % mass basis. The values in brackets are expressed in % carbon basis^{43,44}.

	Total carbon	Biogenic fraction	MSW refuse composition		Biogenic carbon	
			Spain	Sweden	Spain	Sweden
Organic matter	48	(100)	49	31	20	15
Paper-cardboard	44	(99)	19	23	6	10
Plastics	60	(0)	12	14	0	-
Textiles	55	(50)	4	12	2	3
Wood	50	(100)	1	-	1	
Hygiene products	50	(36)	-	12	-	2
Inert waste	3	(0)	16	8	0	-
Total					29 (76)	31 (66)

Table 2. Energy and material balance of the thermochemical biorefinery producing biofuels from RDF.

Input ^a		Process		Output	
RDF (MW _{th})	100	Net efficiency	35% ^b	Ethanol (Mt/yr)	23.7
RDF (t/h)	22.5	Electricity consumption in RDF production (GWh/yr)	8.2	DME (Mt/yr)	6.6
LHV (MJ/kg)	16		105.5	Net electricity (GWh/yr)	34.8

TOTAL (TJ/yr)	2843	Waste heat available for district heating (GWh/yr)		TOTAL (TJ/yr)	995
------------------	------	--	--	------------------	-----

Incorporation of Bio-CCS			
Process		Output	
Electricity consumption in the Bio-CCS process (GWh/yr)	4.6		
Carbon captured in the Bio-CCS process (t carbon/h)	1.5	Net electricity (GWh/yr)	30.2
Carbon captured relative to emitted in the thermochemical biorefinery	25%	TOTAL (TJ/yr)	978

^a The efficiency in the conversion of MSW refuse in RDF is assumed to be 70%^{19,25}.

^b The net efficiency increases up to 40% if district heating is produced.

3.3. Modelling of the thermochemical biorefinery

For the life cycle inventory of the biorefinery, we rely on a previous work where we modelled a thermochemical biorefinery producing dimethyl ether (DME) and ethanol from lignocellulosic biomass^{45,46}. In the same work, we explored the potential of CO₂ capture and storage (i.e., Bio-CCS). For the production of biofuels, the MSW refuse has to be pre-treated and converted into a solid fuel, called either refuse derived fuel (RDF) or solid recovered fuels (SRF), which is then further processed in a thermochemical biorefinery. In this study, the term RDF is preferred to SRF, since the latter applies to a European Standard for the use of the fuel in conventional energy applications, e.g. co-firing in power plants⁴⁷. The pre-treatment of MSW refuse consists of a shredder to reduce the particle size, a trommel to separate small particles, and a magnetic separator and an eddy current separator for ferrous and non-ferrous metals recovery. Finally, the RDF is pelletised to increase the density in order to allow a better handling^{48,49}. RDF from MSW refuse usually has a heating value of about 16 MJ/kg^{12,19,25}. Table 2 shows the energy and material balance of the biorefinery. Electricity surplus is available as a co-product in the process. The difference between the thermochemical biorefinery with and without Bio-CCS incorporation is in

the total net electricity production since some of the produced electricity is consumed in the conditioning of CO₂ capture^{50,51}.

3.4. Static LCA assessment: GHG balance and differential GHG impact

3.4.1. GHG balance and saving

The GHG balance (E_{biofuel}) is defined as an annual average of all anthropogenic cradle-to-grave GHG emissions in the production of biofuels using MSW refuse. The biogenic carbon stored in landfill and from Bio-CCS incorporation is modelled as a negative contribution. The methodology for the calculation has been previously discussed by the authors using lignocellulosic biomass⁵², using the standard LCA characterization method, GWP(100), and characterisation factors defined by IPCC AR5 (see part 2 in SM). However, when using MSW refuse, it needs to be extended to include the fossil fraction in MSW refuse⁴³⁻⁴⁴ (see part 3.1 in SM). The saving of GHG in the production of biofuel (compared to emissions from transportation fuels) is calculated using the guidelines from RED (see part 3.1 in SM).

3.4.2. Differential GHG impact

The differential GHG impact (Eq. 1) compares, in terms of GHG emissions reduction, the use of MSW refuse for the production of biofuels with the reference system (BAU)⁵³. It differs from the GHG balance in the consideration of the displaced and/or avoided emissions due to both material and energy substitution (i.e., it includes the burdens). The GHG impact of the BIO (E_{BIO}) and BAU (E_{BAU}) systems are calculated using Eq. 2 and 3 respectively. Moreover, the standard LCA characterisation method, GWP(100), and characterisation factors defined by IPCC AR5 (see part 3.2. and 3.3. in SM) are also used. Avoided emissions are represented by a fossil reference value (EF) according to the mix of products from the biorefinery. The EF value for fossil transportation fuels is 90.3 g CO₂/MJ according to the latest recommendation from the Joint Research Centre (JRC)¹⁰. For electricity, the fossil reference is the average GHG emissions of the grid mix of the assessed country^{39,54,55} (Table 3). The EF value for electricity is used in the bioenergy system to calculate the fossil emissions from the electricity grid to balance the electricity production in the BAU system (y_3). The EF value for transportation fuels allows calculating the GHG emissions from the production of fossil transportation fuels (z_1).

$$\text{Differential GHG impact} = E_{\text{BIO}} - E_{\text{BAU}} \quad (\text{Eq. 1})$$

Table 3. Fossil references for fuel and electricity production and shares of electricity and biofuel production (LHV basis) in BIO and BAU systems from Figure 3.

	Spain	Sweden
EF_{fuel}^{10} (g CO ₂ eq./MJ)	90.3	
$EF_{electricity}^{39}$ (g CO ₂ eq./MJ)	110.7	17.5
EF_{heat}^{56} (g CO ₂ eq./MJ)	-	-68
x_1	0	52%
x_2	0	9%
x_3	0	43%
y_1	10%	0%
y_2	37%	47%
y_3	38%	15%
y_4	9%	5%
$Z_{1,2}$	53%	28%

$$E_{BIO} = E_{biofuel} \cdot (Z_2 + y_4 + x_2) + EF_{electricity} \cdot y_3 + EF_{heat} \cdot x_3 \quad (\text{Eq.2})$$

$$E_{BAU} = EF_{fuel} \cdot Z_1 + (E_{landfill} \cdot r_{landfill} + E_{incineration} \cdot r_{incineration}) \cdot (x_1 + y_1 + y_2) \quad (\text{Eq.3})$$

$E_{landfill}$ represents the GHG emissions from the landfill, which depend on the behaviour of landfilled materials. Figure S1 in the SM shows the parameters assumed in this study. Although IPCC and EPA establish default values, some parameters are country-specific and even vary between regions (see part 3.2 in SM)⁵⁷⁻⁵⁹. $E_{incineration}$ represents the GHG emissions from MSW refuse incineration (see part 3.3 in SM). The results in terms of grams of CO₂ equivalent per ton of MSW

refuse are corrected by the system efficiency (Eq. 4) to use the same functional unit in both systems: 1 MJ of total products from the biorefinery. The purpose of this correction factor is to include the impact of the different conversion efficiencies in the BAU system compared with the BIO system.

$$E_i = \frac{\text{g CO}_2 \text{ eq}}{\text{t MSW refuse}} \cdot \frac{\text{t MSW refuse/year}}{(\text{MJoutput/year}) \cdot \left(\frac{\eta_i}{\eta_{\text{biorefinery}}}\right)} \quad (\text{Eq. 4})$$

where i is landfill or incineration

3.5. Dynamic assessment: CMI and DCI

To calculate the time-dependent climate mitigation potential, each individual WMGHG has been modelled in BIO and BAU systems. The calculation is based on two climate metrics: AGWP and AGTP. IPCC methodology is used and parameters for each individual WMGHG are taken from IPCC AR5.

3.5.1. CMI

The climate mitigation index (CMI) assesses the mitigation potential of producing biofuels from MSW refuse instead of following current MSW management systems. The CMI is dimensionless. For each region assessed (Spain or Sweden), the feedstock is identical independently of how the MSW refuse is disposed of. Therefore, since the re-absorption factor is equal in both systems, all GHG emissions (CO₂ included) are counted from the MSW refuse for both biogenic and fossil origin. The CMI is calculated according to Eq. 5^{42,44}. The values of AGWP for BIO and BAU systems are calculated from the annual emissions of each WMGHG as explained elsewhere^{18,40,41} (see part 4 in SM).

Regarding the values of CMI, it is possible to compare the behaviour of the BIO system with the current MSW management, and electricity and transportation fuels (i.e., the BAU system) for a specific region (Scheme 1). Since the CMI is based on the AGWP values, this comparison gives the cumulative climate mitigation of producing biofuels. Therefore, if the CMI reaches a positive value at a certain time, it means that at this time there is no accumulated climate benefit, i.e., the BIO system starts to be worse than the BAU system. For negative CMI values, there is an

accumulated climate benefit, until the CMI reaches -1 when then the BIO system has no emissions of WMGHG.

$$CMI = \frac{(AGWP_{BIO} - AGWP_{BAU})}{AGWP_{BAU}} \quad (\text{Eq.5})$$

$CMI > 0 \rightarrow AGWP_{BIO} > AGWP_{BAU} \rightarrow$ Climate worsening

$CMI = 0 \rightarrow AGWP_{BIO} = AGWP_{BAU} \rightarrow$ Climate neutral

$-1 < CMI < 0 \rightarrow AGWP_{BIO} < AGWP_{BAU} \rightarrow$ Climate mitigation

$CMI = -1 \rightarrow AGWP_{BIO} = 0 \rightarrow$ BIO is climate neutral

(Scheme 1)

3.5.2. DCI

The differential climate impact (DCI) measures the climate benefit in the production of biofuels from MSW refuse in order to compare the results of regions with different waste management systems. The units of DCI are K·kg MSW refuse⁻¹. In different regions, feedstock composition differs and therefore the biogenic emissions cannot be modelled as for the CMI³⁶. As mentioned above, in this case it is only possible to account for fossil carbon and biogenic non-CO₂ emissions. In the same way, the biogenic carbon stored in landfill and from Bio-CCS incorporation are modelled as negative contributions. The DCI is based on the AGTP metric as the surface temperature response to the replacement of BAU by BIO (Eq. 6). The values of AGTP for BIO and BAU systems are calculated from the annual emissions of each WMGHG as explained elsewhere^{18,40,41} (see part 4 in SM).

Regarding the values of the DCI, a direct comparison of two different regions can be made. Since the DCI is based on AGTP values, the comparison gives the climate benefit at a specific time; an instantaneous comparison that is not influenced by the accumulated effect of previous WMGHG emissions. Therefore, if the DCI of one region is lower than in another region, it means that there is a larger climate benefit in the production of biofuels in this region at a specific time.

$$\text{Differential climate impact} = \text{AGTP}_{\text{BIO}} - \text{AGTP}_{\text{BAU}} \quad (\text{Eq. 6})$$

3.6. Scenarios modelled

Two scenarios for current MSW refuse management, transportation fuels and power sector are considered (i.e., BAU system). In both scenarios, the production of biofuels in the BIO system is considered to be continuous; that is 1 MJ of products (biofuels and electricity) is produced every year.

For the two BAU systems, we consider two hypothetical future evolutions:

- *Scenario 1.* The production of biofuels is continuous. In this scenario, we assume that the BAU system, i.e., MSW management system and energy mix (transportation fuels and electricity) do not change for the whole period. This scenario applies for both the static and dynamic assessments. For further details, see part 3 in SM.
- *Scenario 2.* It considers an evolution of the BAU system according to the legal targets and recommendations set by the European Commission. This scenario applies only for the time-dependent assessment since it involves an evolution of the BAU system. This evolution brings a landfill-banned BAU system and would also be closer to the future evolution of MSW management in Europe^{2-4,60}. Considering the selected regions, the targets set in the landfill and the waste framework Directives have been already achieved in Sweden but not in Spain^{21,61}. Therefore, Spain should reduce the amount of biodegradable municipal waste in MSW refuse and its landfilling rate⁶¹. The Spanish National Framework Plan for Waste Management 2015-2020 establishes the baselines for the future MSW management in an attempt to meet the European targets⁶². We assume a delay of 5 years in fulfilling these requirements (Figure 5 and part 5 in SM). Therefore, the targets set in the national plan are used to define the evolution of the MSW management system in Spain for the first 5 years, e.g. 50% of recycling, 35% of landfilling and 15% of energy recovery. From year 2025 to 2120, we propose 1% of landfilling, 65% of recycling and 34% of energy recovery. As Sweden is closer to the European targets than Spain, we consider an objective of 1% of landfilling, 65% of recycling and 34% of energy recovery in the year 2120. In both countries, the increase of recycling rates is expected with the introduction of new technologies improving efficiency and sorting capacity. Therefore, we assumed the same MSW management system for both countries in the long term.

Although only a time-dependent assessment can include the impact of scenario 2, it is necessary to adapt the data used in a conventional stationary assessment to get the annual emissions of each WMGHG. In Figure 6, it can be seen that landfilling emissions decrease progressively due to the increase of incineration and recycling rates. Because of this, incineration and biofuel production emissions rise in Spain, whereas they keep practically stable in Sweden. In relation to the energy mix, in Sweden the average CO₂ emissions per MWh of electricity has been practically constant in the last decades (0.063 t fossil CO₂/MWh_e)³⁹. This value is much lower than the emissions in Spain (0.398 t fossil CO₂/MWh_e)³⁹ because of the larger share of nuclear and renewable energy in Sweden. Therefore, we assumed Sweden would keep constant emissions and Spain would gradually reduce its emissions until both countries reach the same level in 2120. Likewise, GHG emissions from district heating in Sweden would also keep constant.

4. Results

4.1. Static assessment

4.1.1. GHG balance and saving

Table 4 shows the results of GHG balance (E_{biofuel}) and saving achieved according to the current European regulation. The individual contribution of each parameter to the results is shown in Table S13 and Figure S3 in SM. The GHG balance is lower for Spain due to the lower carbon content and the higher biogenic content in MSW refuse, achieving a saving of GHG emissions compared with the fossil reference. If Bio-CCS was incorporated, the saving would be above the target for biofuels in 2018 (60%)¹⁰. For Sweden, there would not be any saving even if Bio-CCS was incorporated.

Figure 5. Forecast for the Spanish and Swedish MSW management systems in scenario 2. Data are expressed in terms of the main WMGHG released.

Table 4. Results of the GHG balance and saving in the production of biofuels, calculated according to EU regulation.

Parameters	Without Bio-CCS	With Bio-CCS
------------	-----------------	--------------

	Spain	Sweden	Spain	Sweden
E_{biofuel} (g CO ₂ eq./MJ)	69	110	28	71
Saving (%)	4	-257	61	-130

Figure 6. Evolution of emissions from the BAU system in scenario 2. For clarity, the yearly emissions of each WMGHG are combined and expressed in g CO₂ eq./MJ. For a detailed evolution of each WMGHG, see Tables S11 and S12 in SM.

Figure 7. Results of the differential GHG impact in the production of biofuel from MSW refuse (scenario 1).

4.1.2. Differential GHG impact

Figure 7 shows the results for the differential GHG impact, which includes the comparison with the BAU system. It can be seen that the GHG impact of the bioenergy system is higher in Spain than in Sweden since the lower emissions in the production of the biofuel in Spain (where there is a higher biogenic fraction in the MSW refuse) cannot balance the lower emission factor for the Swedish electricity grid and the negative emission factor for the Swedish heat mix (see Table 3). The GHG impact of the BAU system is also higher for Spain because of the landfill emissions (twice than those from incineration). The differential GHG impact is negative for both countries (i.e., a positive climate impact) but higher in the case of Sweden (-161 g CO₂ eq./MJ) than in Spain (-76 g CO₂ eq./MJ) since district heating producing results in a clear advantage from the point of view of GHG reduction. In both cases, Bio-CCS incorporation involves a similar reduction (around 40 g CO₂ eq./MJ) of the climate impact.

4.2. Time-dependent assessment: CMI

4.2.1. Scenario 1

Figure 8 shows the CMI values for scenario 1. In the case of Spain, there is a sharp reduction of the index from positive to negative and subsequent stabilisation. There is no mitigation until 5 years after the beginning of biofuels production, when up to 45% mitigation is achieved in 2040. Since the transient emissions from the landfill are concentrated around 20 years after the landfilling of the MSW refuse (*landfill memory*, see part 3 in SM), this behaviour was already expected. The mitigation is then reduced until 2120, when the CMI would be slightly positive (4% worse than the BAU system). Therefore, there is no long-term climate benefit in the production of biofuels from MSW refuse in Spain. Considering Sweden, the climate change mitigation is obtained for the whole period considered, where an almost constantly mitigation of 41% is achieved. The mitigation for Sweden is higher than the Spanish one in the first 12 years and after year 2050. Therefore, the production of biofuels would only achieve a larger climate mitigation compared with the BAU system in Spain in the medium term.

Comparing these results with the static assessment, it is clear that these results could not have been predicted from the GHG saving or differential impact. For instance, the differential GHG impact gave a higher climate benefit for Sweden. The static assessment gives an underestimation of the climate benefit in the production of biofuels in a landfill-dominant region like Spain. The results of incorporating Bio-CCS are also different from the stationary assessment. The effect of Bio-CCS incorporation is slightly lower in the time-dependent assessment.

Figure 8. Climate mitigation index for Spain (a) and Sweden (b) with and without Bio-CCS incorporation in scenario 1 where y-axis is CMI, x-axis is year. For clarity, the year 0 is not represented.

Figure 9. Climate mitigation index in Spain (a) and Sweden (b) with and without Bio-CCS incorporation for scenario 2 where y-axis is CMI, x-axis is year. For clarity, the year 0 is not represented.

4.2.2. Scenario 2

Figure 9 shows the CMI values for scenario 2. For Sweden, the differences between scenario 1 and 2 are minimal. This was expected since Sweden is already close to achieve the proposed targets for MSW management and electricity production, so only the evolution in the emissions from fossil transportation fuels is affecting the results (with a minor impact). However, for Spain, an important difference can be seen in the trend from the beginning because of this evolution of the BAU system. Compared with scenario 1, Spain faces a landfill banning that has a larger impact on the results. Since the landfilling rate is drastically reduced at an early stage, the sharp decrease of the index values is less than in scenario 1 (over half). However, the climate mitigation only occurs after 5 years as in scenario 1. The mitigation reaches a maximum of 51% in 2040, slightly above scenario 1. Later, the impact of higher emissions from incineration, which increases its share in Spanish MSW management, balances the mitigation reduction and in 2090, the mitigation starts to increase again. In 2010, 40% mitigation is achieved for Spain with a positive trend. Not surprisingly, since both countries meet the same targets for the BAU system in this scenario and their climate benefits are equal after the analysed period. The effect of Bio-CCS incorporation is similar to scenario 1.

4.2.3. Sensitivity analysis

There are several parameters affecting the calculation of the CMI, i.e., the fraction of carbon storage when Bio-CCS is incorporated, the efficiency in biofuel production (thermochemical biorefinery) and the efficiency in the collection of biogas from the landfill. For the sake of clarity, only scenario 1 is used in the analysis, although similar trends are expected for scenario 2.

In the selected configuration of thermochemical biorefinery, the available CO₂ for permanent storage is approximately 25% of the total carbon emitted in the plant⁴⁵. This amount corresponds to the already captured pure CO₂ from the syngas in the original thermochemical biorefinery (due to process requirements of the biofuel synthesis catalyst) using pre-combustion technologies. However, it is possible to capture almost all CO₂ from the flue gases by increasing both plant complexity and capital and operating costs. Figure 10 shows that the impact of Bio-CCS incorporation is similar in both assessed regions regardless of the MSW management. By increasing the capture rate from 0 to 100% of the total carbon emitted in the thermochemical biorefinery, the climate mitigation also increases greatly. Maximum mitigations of 60 and 97% can be achieved for complete capture in Spain and Sweden respectively in 2120. The incorporation of Bio-CCS at large capture levels would be then a clear option to obtain long-term climate change

mitigation irrespective of the MSW management system. However, it would involve the capture of CO₂ from flue gases, using post-combustion technologies, which is currently only considered for large power plants.

Figure 10. Sensitivity of the climate mitigation index to the carbon captured in the plant for Spain (a) Sweden (b) in scenario 1 where y-axis is CMI, x-axis is year. For clarity, the year 0 is not represented.

Figure 11. Sensitivity analysis of the mitigation climate index to the energy efficiency of the thermochemical biorefinery for Spain (a) and Sweden (b) in scenario 1 (HHV basis) where y-axis is CMI, x-axis is year. For clarity, the year 0 is not represented.

The efficiency in the production of biofuels (35%, HHV basis, in the selected configuration of thermochemical biorefinery and 40% if district heating is produced) could affect the results. Although it is not the aim of this study to assess technical aspects of thermochemical biorefineries, Figure 11 shows the impact of efficiency on climate mitigation. The impact of the energy efficiency is similar for both countries, as it was expected since the efficiency is proportional to the MSW refuse input to the BIO system (see Eq. 4). Considering the values of efficiency analysed, in the production of liquid biofuels (transportation fuels) typical values range from 35 to 45%⁶³. Therefore, the impact of efficiency on the potential climate benefit of producing biofuels from MSW refuse is limited. However, considering the case of Spain, the climate mitigation could be 14% in 2120 (-4% in the base case).

The efficiency in biogas collection in the landfill is the last parameter affecting the CMI results, although only for regions with landfilling, since it is an attribute of the BAU system. A higher collection of biogas in the landfill involves less biogas emissions to the atmosphere. Therefore, it is important to assess the impact of biogas collection (70% in our study). As estimated by the EPA, from 55 to 95% of the biogas produced is collected in modern landfills⁵⁹. Figure 12 shows the impact of this variation for Spain, where in case of a very efficient biogas collection (95%), the

mitigation potential decreases greatly being zero in 2080 and reaching a worsening of 25% in 2120, which is the worst case in this study for Spain. However, considering specific references for biogas collection in current landfills from Southern and Eastern Europe, no more than 50-55% is actually collected⁶⁴⁻⁶⁶. Considering this, climate mitigation would be 10% in 2120. This value is, however, less than the potential climate benefit considering a reasonable improvement of the energy efficiency in the thermochemical biorefinery, as mentioned above.

Figure 12. Sensitivity analysis of the climate mitigation index to the biogas collection from the landfill for Spain in scenario 1 where y-axis is CMI, x-axis is year. For clarity, the year 0 is not represented.

4.3. Time-dependent assessment: DCI

4.3.1. Scenario 1

Figure 13a shows the results for the DCI in scenario 1. As opposed to the CMI, the DCI represents an instantaneous metric, so methane impact is rapidly balanced as previously mentioned. The results are in agreement with those of CMI, although some extra information can be obtained here. In the short term, Spain has a potential climate benefit of $-6.5 \cdot 10^{-16}$ K·kg of MSW refuse⁻¹ in 2040, whereas Sweden achieves only $-2 \cdot 10^{-16}$ K·kg⁻¹. This makes it even more evident that avoided methane emissions from the landfill only have a short-term impact. Compared with the results for the CMI in scenario 1, the Spanish climate benefit becomes zero in 2080, 30 years before. The reason is the comparison of an instantaneous (DCI) and a cumulative (CMI) metric, where 30 years is the time required to overcome the cumulative climate benefit in the production of biofuels in Spain (the bottom peak). In the long term, biofuel production shows a climate worsening for Spain ($0.6 \cdot 10^{-16}$ K·kg⁻¹), whereas for Sweden it is still $-1.3 \cdot 10^{-16}$ K·kg⁻¹. For instance, only the production of biofuels in Sweden would have a climate benefit in the long term.

4.3.2. Sensitivity analysis

The impact of Bio-CCS incorporation, efficiency in biofuel production and biogas collection efficiency in the calculation of the DCI follow the same trend as in the sensitivity analysis of the

CMI (see SM). However, the biogenic fraction in the MSW refuse has an impact on the DCI that cannot be seen in the CMI, since all emissions were equally treated. Therefore, a sensitivity analysis varying the biogenic fraction in MSW refuse from 50 to 100% is presented in Figure 13a. The results are converse depending on the country. For Sweden, the higher the renewable fraction is, the less positive climate impact, since BAU system fossil emissions (incineration) also decrease. Therefore, the use of wastes with high biogenic fraction, e.g. compost, would be discouraged. For Spain, if the renewable fraction increases, so do the landfill emissions, since biogas comes from the biodegradable fraction. The decrease of incineration emissions is not enough to balance the net BAU system emissions (Figure 13b). Therefore, the use of wastes with high biogenic fraction, e.g. compost, would have a positive impact. If the MSW refuse has a large fraction of non-biogenic carbon, e.g. plastics, the permanent storage of this carbon in the landfill balances the climate benefit of producing biofuels.

4.3.3. Scenario 2

Figure 14 shows the results for scenario 2 where Spanish BAU system evolves to become the same as the Swedish beyond 2120. The results are in agreement with those of CMI. In Spain, the landfill banning becomes important after 20 years due to landfill disposal decreases until the half of current levels is reached. Moreover, the emissions from the electricity mix are lower than the emissions from incineration, making the total emissions in the BAU system increase. Hence, the maximum climate benefit for Spain is reduced in a 57% compared with scenario 1 in 2037 (2.84 and $6.58 \cdot 10^{-16} \text{ K} \cdot \text{kg}^{-1}$ respectively), but it is enhanced in the long term since the DCI never becomes positive. At the end of the considered period (2120), the DCI reveals a climate benefit of $-1 \cdot 10^{-16} \text{ K} \cdot \text{kg}^{-1}$. As it happened before, the results for Sweden are the same as in scenario 1.

Figure 13. a) Differential climate impact (lines) and sensitivity to the biogenic fraction in MSW refuse (areas) for Spain (grey) and Sweden (brown) in scenario 1 where y-axis is DCI ($\text{K} \cdot \text{kg}^{-1}$), x-axis is year. The lines represent the base cases and areas of the results of the sensitivity analysis. The dash line represents the Spanish base case if the biogenic fraction was the same than the Swedish. For clarity, the year 0 is not represented. b) Sensitivity of the emissions in

BAU and BIO systems to the biogenic fraction (%). The emissions are expressed in terms of the main WMGHG released.

Figure 14. Differential climate impact for Spain (red) and Sweden (yellow) when an evolution of BAU system is considered (scenario 2) where y-axis is DCI ($\text{K}\cdot\text{kg}^{-1}$), x-axis is year.

5. Discussion

This study offers indications of the potential climate change mitigation provided by using MSW refuse as a feedstock for the production of transportation biofuels. In order to provide a complete analysis, both static and time-dependent assessments are illustrated. The static assessment (GHG balance, saving and differential impact) offers clear quantitative results, such as the GHG savings indicator which is currently used in Europe for the certification of biofuels. However, the drawbacks of static life cycle assessments have become apparent in the last years. Static assessments, such as commonly found in the literature, cannot properly capture the impact of landfills in the evolution of GHG emissions with time and thus are unable to properly assess the climate change mitigation of the bioenergy system. Especially when considering potential dynamic evolution of both energy mix and MSW management system in a 100-years period, only the time-dependent assessment can provide a proper impact assessment. This is less evident for the case of a region with current negligible landfilling where the systems considered do not change in time and where the main WMGHG is CO_2 and not a short-lived GHG such as methane.

It is relevant that the climate mitigation achieved by the production of biofuels is similar in the first 30 years for both countries studied, but it diverges in the long term. In regions with current dominant landfilling, in fact, the climate impact after 100 years is equal or slightly worse for the bioenergy system compared to the continuation of the BAU system. However, other relevant impacts and risks associated to the BAU system should be assessed in order to avoid a shift of environmental burdens different from climate change in the production of biofuels from MSW refuse.

We have considered a conservative value for the share of MSW disposal in modern landfills (70%) in Spain⁶⁷ in order to compare processes at a similar readiness level. The production of biofuels would result even more advantageous if the substitution of the landfills with the worst biogas collection efficiencies in Europe was prioritised. For the incineration, conservative efficiency

values for new incineration plants with energy recovery have also been used. The capture efficiency for Bio-CCS incorporation in this study is 25%; this value corresponds to the amount of pure CO₂ that needs to be captured in the biorefinery to guarantee proper functioning of the catalytic synthesis downstream⁴⁵. This capture efficiency is above typical values in biochemical production of ethanol (11-13%)^{68,69}. A higher capture efficiency would require an increase of both investment and operational costs to capture the carbon present in flue gases (i.e., post-combustion technologies), increasing process complexity and worsening its economy^{63,70}. Therefore, the impact of Bio-CCS incorporation would be limited in the production of biofuels from MSW refuse. When the impact of the biogenic fraction of MSW refuse was analysed, the results for 100% biogenic fraction are indirectly related with the use of the organic sorted fraction of MSW (usually converted into compost). However, this fraction is currently not promoted for biofuel production²¹.

Finally, some authors consider that the carbon from wood and paper requires a specific treatment for the counting of GHG emissions⁷¹⁻⁷², and therefore, distinguish them from food waste. However, in this study we consider that this carbon has spent sufficient time in the products pool so that the original biomass plant has fully regrown.

We considered multiple system configurations so to highlight potential improvements and additional risks. This sensitivity analysis shows that the climate mitigation for Spain is uncertain in the long term (ranging from -4 to 14%). Therefore, climate benefit cannot be claimed in the production of biofuels in a current landfill-dominant country, but, and this is crucial, neither a significant climate worsening. The only case providing a clear climate benefit would be in a country with current negligible landfilling coinciding in Europe with countries requiring district heating production, where the climate mitigation could represent 41% (constant for the whole period) compared with the BAU system. However, these results are derived from scenario 1, where the MSW management system of the countries is supposed to keep unchanged for 100 years.

Scenario 2 has analysed an evolution of the BAU system on the assumption of a stable policy strategy for MSW management throughout Europe according to the European targets and in line with the principles of the Circular Economy. The banning of landfilling has revealed as the most significant change. The promotion of landfill banning, despite being a very entrenched practice in Southern and Eastern Europe⁷³⁻⁷⁵, would equalise the climate mitigation in the production of biofuels in Spain and Sweden. This result is another example of how the contribution of landfills in climate change is still not fully understood. Instead of being a climate burden because of their methane emissions, it favourably compares with the alternative disposal of MSW refuse (i.e.,

incineration) because of the storage of biogenic carbon in the landfill. Moreover, the decarbonisation of the transport sector suffers from a lack of alternatives compared with the power sector. The favourable comparison of biofuels production from MSW refuse in a progressively decarbonised BAU system proves that MSW refuse should not be considered as a priority source for electricity production.

6. Conclusions

The production of biofuels from MSW refuse would achieve climate change mitigation in Europe in the medium term. Hence, the substitution of current MSW management (landfill and/or incineration) for the production of biofuels would likely not cause a negative burden for climate change. However, there are important differences for the two extreme examples of current MSW management and electricity pool analysed, Spain (landfilling is dominant, high emissions) and Sweden (landfilling is negligible, low emissions). In Spain, the impact of landfill emissions prevents a climate benefit in the long term, although it does not represent a climate worsening. Therefore, a strategic decision on the MSW management change would mainly rely on avoiding the environmental impacts of landfilling, which are different from those of climate change. In Sweden, the climate benefit is present at all times. Only in the case of landfills with a low biogas collection efficiency, the substitution of the landfill by biofuel production would be clearly positive for the climate in both medium and long terms.

Considering an evolution of the reference system for MSW refuse in Europe (including MSW management, but also electricity and transport sectors), the results become similar for Spain and Sweden in the long term. For instance, in the case of Spain, a clear climate benefit appears. The analysed evolution assumes a progressive banning of landfilling in Europe, decarbonisation of the electricity sector and increase of the emissions from fossil transportation fuels. The favourable comparison of biofuels production from MSW refuse in a progressively decarbonised BAU system proves that MSW refuse should not be considered as a priority source for electricity production but for biofuel production. These results provide policy makers with a scientific basis for the encouragement of MSW refuse in the production of biofuels in Europe.

Acknowledgements

This work has been funded by the Spanish Ministry of Economy and Competitiveness and partially carried out in the framework of the BIOTER project (*Proyecto de Investigación Fundamental No-*

Orientada; ENE2012-31598). Pedro Haro thanks the *Universidad de Sevilla* for the post-doctoral Grant *Contrato de Acceso al Sistema Español de Ciencia, Tecnología e Innovación* (VPPI-US).

Abbreviations

BAU: business as usual (reference system)

BIO: bioenergy

Bio-CCS: carbon capture and storage in bioenergy

DME: dimethyl ether

DOC: degradable organic carbon

EPA: Environmental Protection Agency

GGR: greenhouse gases removal

GHG: greenhouse gases

IEA: International Energy Agency

IPCC: Intergovernmental Panel on Climate Change

JRC: Joint Research Centre

LCA: Life Cycle Assessment

LHV: Lower Heating Value

MSW: municipal solid waste

RDF: refuse derived fuel

RED: Renewable Energy Directive

SRF: solid recovered fuel

WMGHG: Well-Mixed greenhouse gases

Nomenclature

AGTP: Absolute Global surface Temperature change Potential, $\text{K}\cdot\text{kg}^{-1}$

AGWP: Absolute Global Warming Potential, $\text{W}\cdot\text{year}\cdot\text{m}^{-2}\cdot\text{kg}^{-1}$

CMI: climate mitigation index, —

DCI: differential climate impact, $\text{K}\cdot\text{kg}$ of MSW refuse⁻¹

EF_i: emissions from the fossil reference for *i* (transportation fuels or electricity), g CO_2 eq. per MJ

E_i: emissions from MSW refuse in *i* (landfilling, incineration, BAU system, biofuel production or BIO system), g CO_2 eq. per MJ of product from the biorefinery (biofuel and electricity)

GTP: Global surface Temperature change Potential, —

GWP: Global Warming Potential, —

R: atmospheric decay of a gas, —

RF: Radiative Forcing, $\text{W}\cdot\text{m}^{-2}\cdot\text{kg}^{-1}$

$r_{\text{incineration}}$: fraction of MSW refuse incinerated in the region assessed, %

r_{landfill} : fraction of MSW refuse landfilled in the region assessed, %

x_i : ratio of heat production (1 BAU system, 2 BIO system)

y_i : ratio of electricity production (1 landfill, 2 incineration in BAU system; 3 electricity mix, 4 biorefinery in BIO system)

z_i : ratio of fuel production (1 BAU system, 2 BIO system)

$\eta_{\text{biorefinery}}$: efficiency of the thermochemical biorefinery producing biofuels, % LHV

η_i : efficiency of the electricity generation in landfill or incineration, % LHV

References

1. Adoption of the Paris Agreement. Framework Convention on Climate Change. Paris 2015
<https://unfccc.int/resource/docs/2015/cop21/eng/l09r01.pdf>

2. Energy Technology Perspectives 2012 - Pathways to A Clean Energy System Executive Summary. IEA International Energy Agency Paris (France). 2012
https://www.iea.org/publications/freepublications/publication/ETP2012_free.pdf
3. World Energy Outlook 2014. Executive Summary. IEA International Energy Agency Paris (France). 2014
https://www.iea.org/publications/freepublications/publication/WEO2014_ESSpanish.pdf
4. Energy Technology Perspectives 2010 – Scenarios and strategies to 2050. IEA International Energy Agency Paris (France). 2010
<https://www.iea.org/publications/freepublications/publication/etp2010.pdf>
5. IPCC, 2014: Climate Change 2014: Mitigation of Climate Change. Contribution of Working Group III to the Fifth Assessment Report of the Intergovernmental Panel on Climate Change [Edenhofer, O., R. Pichs-Madruga, Y. Sokona, E. Farahani, S. Kadner, K. Seyboth, A. Adler, I. Baum, S. Brunner, P. Eickemeier, B. Kriemann, J. Savolainen, S. Schlömer, C. von Stechow, T. Zwickel and J.C. Minx (eds.)]. Cambridge University Press, Cambridge, United Kingdom and New York, NY, USA. <https://www.ipcc.ch/report/ar5/wg3/>
6. Lomax G, Lenton TM, Adeosun A, Workman M. Investing in negative emissions. Nat Clim Change 2015;5(6):498-500.
7. Directive 2009/28/EC of the European Parliament and of the Council of 23 April 2009 on the promotion of the use of energy from renewable sources and amending and subsequently repealing Directives 2001/77/EC and 2003/30/EC. <http://eur-lex.europa.eu/legal-content/EN/TXT/PDF/?uri=CELEX:32009L0028&from=EN>
8. Lapola DM, Schaldach R, Alcamo J, Bondeau A, Koch J, Koelking C, et al. Indirect land-use changes can overcome carbon savings from biofuels in Brazil. Proc Natl Acad Sci U S A 2010;107(8):3388-3393.
9. ILUC Quantification Study of EU Biofuels. https://ec.europa.eu/energy/sites/ener/files/documents/Final%20Report_GLOBIOM_publication.pdf
10. Directive (EU) 2015/1513 of the European Parliament and of the Council of 9 September 2015 amending Directive 98/70/EC relating to the quality of petrol and diesel fuels and amending Directive 2009/28/EC on the promotion of the use of energy from renewable sources.
11. Stichnothe H, Azapagic A. Bioethanol from waste: Life cycle estimation of the greenhouse gas saving potential. Resour Conserv Recycl 2009;53(11):624-630.

12. Onel O, Niziolek AM, Hasan MMF, Floudas CA. Municipal solid waste to liquid transportation fuels - Part I: Mathematical modeling of a municipal solid waste gasifier. *Comput Chem Eng* 2014;71:636-647.
13. Niziolek AM, Onel O, Hasan MMF, Floudas CA. Municipal solid waste to liquid transportation fuels - Part II: Process synthesis and global optimization strategies. *Comput Chem Eng* 2015;74:184-203.
14. Wang L, Templer R, Murphy RJ. Environmental sustainability of bioethanol production from waste papers: Sensitivity to the system boundary. *Energy Environ Sci* 2012;5(8):8281-8293.
15. Schmitt E, Bura R, Gustafson R, Cooper J and Vajzovic A, Converting lignocellulosic solid waste into ethanol for the State of Washington: An investigation of treatment technologies and environmental impacts. *Bioresource technology*. 2012; 104, pp. 400-409.
16. Rada EC. Energy from municipal solid waste, *WIT Transactions on Ecology and the Environment*. 2014, 190 (2), 945-958.
17. Samer M. GHG emission from livestock manure and its mitigation strategies. *Climate Change Impact on Livestock: Adaptation and Mitigation*. 2015:321-346.
18. Giuntoli J, Caserini S, Marelli L, Baxter D, Agostini A. Domestic heating from forest logging residues: Environmental risks and benefits. *J Clean Prod*. 2015; 99:206-16.
19. Arena U, Di Gregorio F, De Troia G, Saponaro A. A techno-economic evaluation of a small-scale fluidized bed gasifier for solid recovered fuel. *Fuel Process Technol*. 2015;131:69-77.
20. Manfredi S, Cristobal J, Torres de Matos C, Giavini M, Vasta A, Sala S, Saouter E, Tuomisto H. Improving Sustainability and Circularity of European Food Waste Management with a Life Cycle Approach; EUR 27657 EN; doi:10.2788/182997 <http://publications.jrc.ec.europa.eu/repository/bitstream/JRC99238/lbna27657enn.pdf>
21. Directive 2008/98/EC of the European Parliament and of the Council of 19 November 2008 on waste and repealing certain Directives. <http://eur-lex.europa.eu/legal-content/EN/TXT/PDF/?uri=CELEX:32008L0098&from=EN>
22. Commission Decision of 3 May 2000 replacing Decision 94/3/EC establishing a list of wastes pursuant to Article 1(a) of Council Directive 75/442/EEC on waste and Council Decision 94/904/EC establishing a list of hazardous waste pursuant to Article 1(4) of Council Directive 91/689/EEC on hazardous waste (2000/532/EC). <http://eur-lex.europa.eu/legal-content/EN/TXT/PDF/?uri=CELEX:32000D0532&from=EN>
23. European Statistics (Eurostat). <http://ec.europa.eu/eurostat/data/database>

24. Boesch ME, Vadenbo C, Saner D, Huter C, Hellweg S. An LCA model for waste incineration enhanced with new technologies for metal recovery and application to the case of Switzerland. *Waste Manage* 2014;34(2):378-389.
25. Yassin L, Lettieri P, Simons SJR, Castillo-Castillo A, Leach M, Ryu C, et al. From incineration to advanced fluid-bed gasification of waste. *Proc Inst Civ Eng : Waste Res Manage* 2009;162(3):169-177.
26. Consonni S, Viganò F. Waste gasification vs. conventional Waste-To-Energy: A comparative evaluation of two commercial technologies. *Waste Manage* 2012;32(4):653-666.
27. Biomass Futures D3.3 report. http://www.biomassfutures.eu/work_packages/work_packages.php
28. Adefeso IB, Rabiú AM, Ikhu-Omoregbe DI. Refuse-derived Fuel Gasification for Hydrogen Production in High Temperature Proton Exchange Membrane Fuel Cell Base CHP System. *Waste Biomass Valoris* 2015;6(6):967-974.
29. Couto ND, Silva VB, Monteiro E, Rouboa A. Assessment of municipal solid wastes gasification in a semi-industrial gasifier using syngas quality indices. *Energy* 2015;93(PA1):864-873.
30. Panepinto D, Tedesco V, Brizio E, Genon G. Environmental Performances and Energy Efficiency for MSW Gasification Treatment. *Waste Biomass Valoris* 2014;6(1):123-135.
31. Prabhansu, Karmakar MK, Chandra P, Chatterjee PK. A review on the fuel gas cleaning technologies in gasification process. *J Environ Chem Eng* 2015;3(2):689-702.
32. Mu D, Seager T, Rao PS, Zhao F. Comparative life cycle assessment of lignocellulosic ethanol production: Biochemical versus thermochemical conversion. *Environ Manage.* 2010; 46(4):565-78.
33. Ballesteros M, Sáez F, Ballesteros I, Manzanares P, Negro MJ, Martínez JM, et al. Ethanol production from the organic fraction obtained after thermal pretreatment of municipal solid waste. *Appl Biochem Biotechnol* 2010;161(1-8):423-431.
34. Colón J, Cadena E, Pognani M, Barrena R, Sánchez A, Font X, et al. Determination of the energy and environmental burdens associated with the biological treatment of source-separated Municipal Solid Wastes. *Energy Environ Sci* 2012;5(2):5731-5741.
35. Plevin RJ, Delucchi MA, Creutzig F. Using Attributional Life Cycle Assessment to Estimate Climate-Change Mitigation Benefits Misleads Policy Makers. *J Ind Ecol* 2014;18(1):73-83.
36. Giuntoli J, Agostini A, Caserini S, Lugato E, Baxter D, Marelli L. Climate change impacts of power generation from residual biomass. *Biomass Bioenergy* 2015;89:146-158.
37. Giuntoli J, Caserini S, Marelli L, Baxter D, Agostini A. Domestic heating from forest logging residues: Environmental risks and benefits. *J Clean Prod* 2015;99:206-216.

38. Agostini A, Battini F, Giuntoli J, Tabaglio V, Padella M, Baxter D, et al. Environmentally sustainable biogas? The key role of manure co-digestion with energy crops. *Energies* 2015;8(6):5234-5265.
39. European Commission EUR 27215 EN – Joint Research Centre – Institute for Energy and Transport Title: Solid and gaseous bioenergy pathways: input values and GHG emissions Author(s): Jacopo Giuntoli, Alessandro Agostini, Robert Edwards, Luisa Marelli Luxembourg: Publications Office of the European Union 2015 – 248 pp. http://iet.jrc.ec.europa.eu/bf-ca/sites/bf-ca/files/files/documents/eur26696_online_final_v3.pdf
40. IPCC, 2013: Climate Change 2013: The Physical Science Basis. Contribution of Working Group I to the Fifth Assessment Report of the Intergovernmental Panel on Climate Change [Stocker, T.F., D. Qin, G.-K. Plattner, M. Tignor, S.K. Allen, J. Boschung, A. Nauels, Y. Xia, V. Bex and P.M. Midgley (eds.)]. Cambridge University Press, Cambridge, United Kingdom and New York, NY, USA, 1535 pp. <http://www.ipcc.ch/report/ar5/wg1/>
41. Sathre R, Gustavsson L. Time-dependent radiative forcing effects of forest fertilization and biomass substitution. *Biogeochemistry*. 2012; 109(1-3):203-18.
42. Pingoud K, Ekholm T, Savolainen I. Global warming potential factors and warming payback time as climate indicators of forest biomass use. *Mitigation Adapt Strat Global Change*. 2012; 17(4):369-86.
43. Jones FC, Blomqvist EW, Bisailon M, Lindberg DK, Hupa M. Determination of fossil carbon content in Swedish waste fuel by four different methods. *Waste Management and Research*. 2013; 31(10):1052-61.
44. IEA Bioenergy Task 36. Energy recovery from renewable content of waste: incentives and methodology for analysing biogenic content of mixed waste. 2012. <http://www.ieabioenergytask36.org/vbulletin/showthread.php?22-Biogenic-content-of-waste-November-2012>
45. Haro P, Ollero P, Villanueva Perales AL, Gómez-Barea A. Thermochemical biorefinery based on dimethyl ether as intermediate: Technoeconomic assessment. *Appl Energy*. 2013; 102:950-61.
46. Haro P, Trippe F, Stahl R, Henrich E. Bio-syngas to gasoline and olefins via DME - A comprehensive techno-economic assessment. *Appl Energy*. 2013; 108:54-65.
47. EN 15357:2012. Solid Recovered Fuels. Terminology, Definitions and Descriptions.
48. Caputo AC, Pelagagge PM. RDF production plants: I. Design and costs. *Appl Therm Eng*. 2002; 22(4):423-37.

49. Caputo AC, Pelagagge PM. RDF production plants: II. Economics and profitability. Appl Therm Eng. 2002; 22(4):439-48.
50. Von Der Assen N, Jung J, Bardow A. Life-cycle assessment of carbon dioxide capture and utilization: Avoiding the pitfalls. Energy Environ Sci 2013;6(9):2721-2734.
51. Boot-Handford ME, Abanades JC, Anthony EJ, Blunt MJ, Brandani S, Mac Dowell N, et al. Carbon capture and storage update. Energy Environ Sci 2014;7(1):130-189.
52. Haro P, Aracil C, Vidal-Barrero F, Ollero P. Balance and saving of GHG emissions in thermochemical biorefineries. Appl Energy. 2015; 147:444-55.
53. Gaudreault C, Miner R. Temporal Aspects in Evaluating the Greenhouse Gas Mitigation Benefits of Using Residues from Forest Products Manufacturing Facilities for Energy Production. J Ind Ecol 2015;19(6):994-1007.
54. CO2 Score Card <http://co2scorecard.org/countrydata/>
55. Spanish Electric Net. <http://www.ree.es/es/publicaciones/estadisticas-del-sistema-electrico-espanol>
56. Systems Perspectives on Biorefineries 2014. Chalmers University of Technology. Goteborg, Sweden. 2014 https://www.chalmers.se/en/areas-of-advance/energy/Documents/Systems%20Perspectives%20on/Systems_Perspectives_on_Biorefineries_2014_v3.1b.pdf
57. European Commission – Joint Research Centre – Institute for Environment and Sustainability: International Reference Life Cycle Data System (ILCD) Handbook – General guide for Life Cycle Assessment – Detailed guidance. First edition March 2010. EUR 24708 EN. Luxembourg. Publications Office of the European Union, 2010. <http://eplca.jrc.ec.europa.eu/uploads/JRC-Reference-Report-ILCD-Handbook-Towards-more-sustainable-production-and-consumption-for-a-resource-efficient-Europe.pdf>
58. IPCC 2006, 2006 IPCC Guidelines for National Greenhouse Gas Inventories, Prepared by the National Greenhouse Gas Inventories Programme, Eggleston H.S., Buendia L., Miwa K., Ngara T. and Tanabe K. (eds). Published: IGES, Japón. <http://www.ipcc-nggip.iges.or.jp/public/2006gl/vol5.html>
59. EPA. 2014. Framework for assessing biogenic CO₂ emissions from stationary sources. Washington, DC: Environmental Protection Agency. <http://www.epa.gov/climatechange/downloads/Framework-for-Assessing-Biogenic-CO2-Emissions.pdf>
60. Slade R, Gross R, Bauen A. Estimating bio-energy resource potentials to 2050: Learning from experience. Energy Environ Sci 2011;4(8):2645-2657.

61. Council Directive 1999/31/EC on the landfill of waste. http://www.central2013.eu/fileadmin/user_upload/Downloads/Document_Centre/OP_Resources/Landfill_Directive_1999_31_EC.pdf
62. State Framework Plan for waste management 2015-2020. Ministry of Agriculture, Food and Environment, Government of Spain (2015) http://www.magrama.gob.es/es/calidad-y-evaluacion-ambiental/participacion-publica/20150601pemarconsultapublica_tcm7-383820.pdf
63. Haro P, Villanueva Perales AL, Arjona R, Ollero P. Thermochemical biorefineries with multiproduction using a platform chemical. *Biofuels, Bioproducts and Biorefining*. 2014;8(2):155-70.
64. Fernández-Nava Y, Del Río J, Rodríguez-Iglesias J, Castrillón L, Marañón E. Life cycle assessment of different municipal solid waste management options: A case study of Asturias (Spain). *J Clean Prod* 2014;81:178-189.
65. Eriksson O, Finnveden G. Plastic waste as a fuel - CO₂-neutral or not? *Energy Environ Sci* 2009;2(9):907-914.
66. Aronica S, Bonanno A, Piazza V, Pignato L, Trapani S. Estimation of biogas produced by the landfill of Palermo, applying a Gaussian model. *Waste Manage* 2009;29(1):233-239.
67. Chacartegui R, Carvalho M, Abrahão R, Becerra J. Analysis of a CHP plant in a municipal solid waste landfill in the South of Spain. *Appl Therm Eng* 2015;91:706-717.
68. Biomass with CO₂ Capture and Storage (Bio-CCS). European Technology Platform for Zero Emission Fossil Fuel Power Plant <http://biofuelstp.eu/downloads/bioccsjtf/EBTP-ZEP-Report-Bio-CCS-The-Way-Forward.pdf>
69. Potential for Biomass and Carbon Dioxide Capture and Storage. IEA-GHG. July, 2011. http://www.ieaghg.org/docs/General_Docs/Reports/2011-06.pdf
70. Lomax G, Workman M, Lenton T, Shah N. Reframing the policy approach to greenhouse gas removal technologies. *Energy Policy* 2015;78:125-136.
71. Guest G, Cherubini F, Strømman AH. Climate impact potential of utilizing forest residues for bioenergy in Norway. *Mitigation Adapt Strateg Global Change* 2013;18(8):1089-1108.
72. Guest G, Strømman AH. Climate change impacts due to biogenic carbon: Addressing the issue of attribution using two metrics with very different outcomes. *J Sustainable For* 2014;33(3):298-326.
73. Cherubini F, Bargigli S, Ulgiati S. Life cycle assessment of urban waste management: Energy performances and environmental impacts. The case of Rome, Italy. *Waste Manage* 2008;28(12):2552-2564.

74. Clausen A, Pretz T. The Relevance of Framework Conditions for Modelling GHG Emissions from rMSW Treatment Systems in EU. *Waste Biomass Valoris* 2016;7(1):175-191.
75. Fiorentino G, Ripa M, Protano G, Hornsby C, Ulgiati S. Life Cycle Assessment of Mixed Municipal Solid Waste: Multi-input versus multi-output perspective. *Waste Manage* 2015;46:599-611.

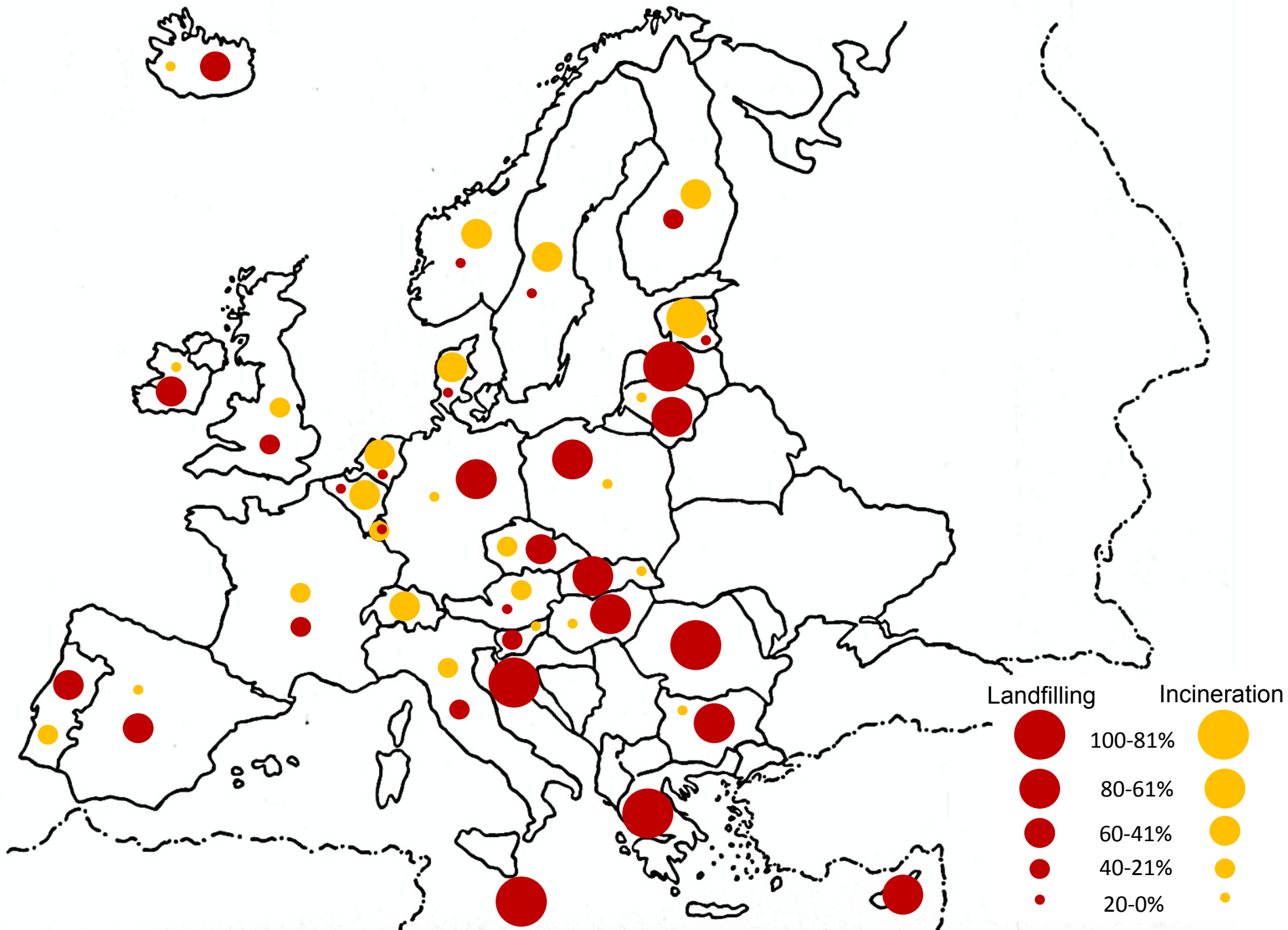

Biofuels production (included in BIO system)

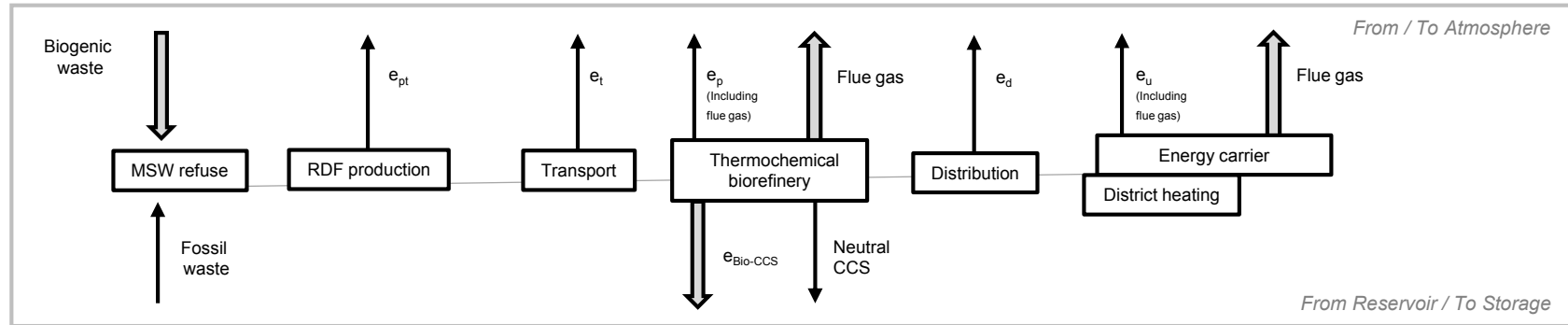

Landfill (included in BAU system)

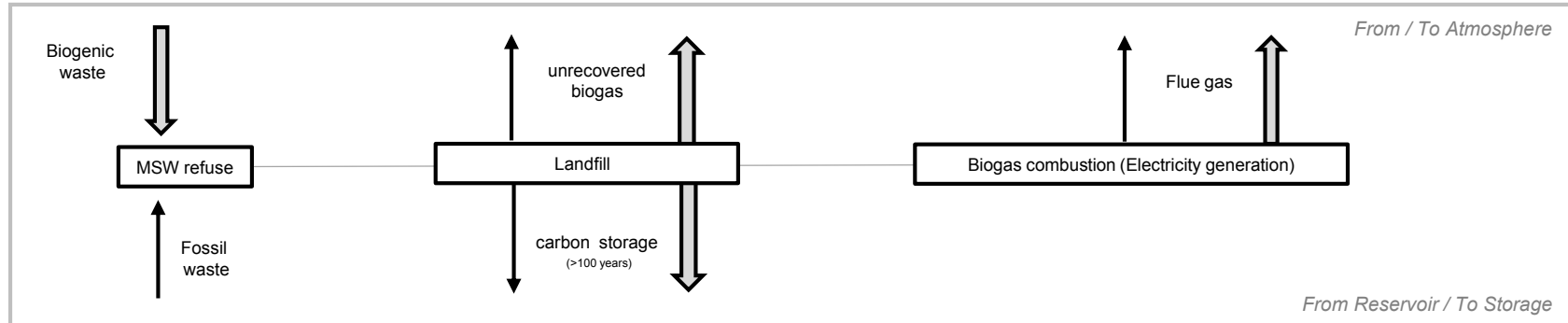

Incineration (included in BAU system)

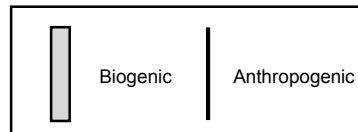
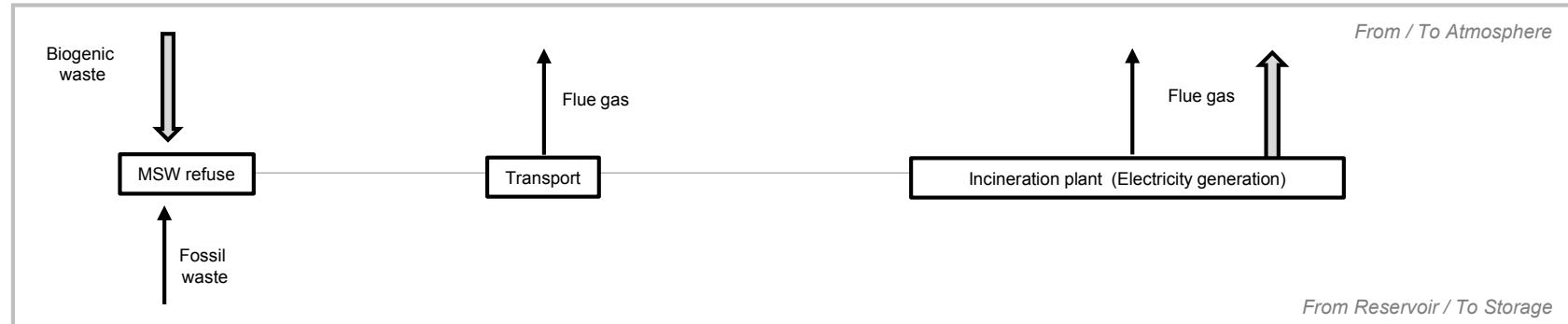

BAU SYSTEM

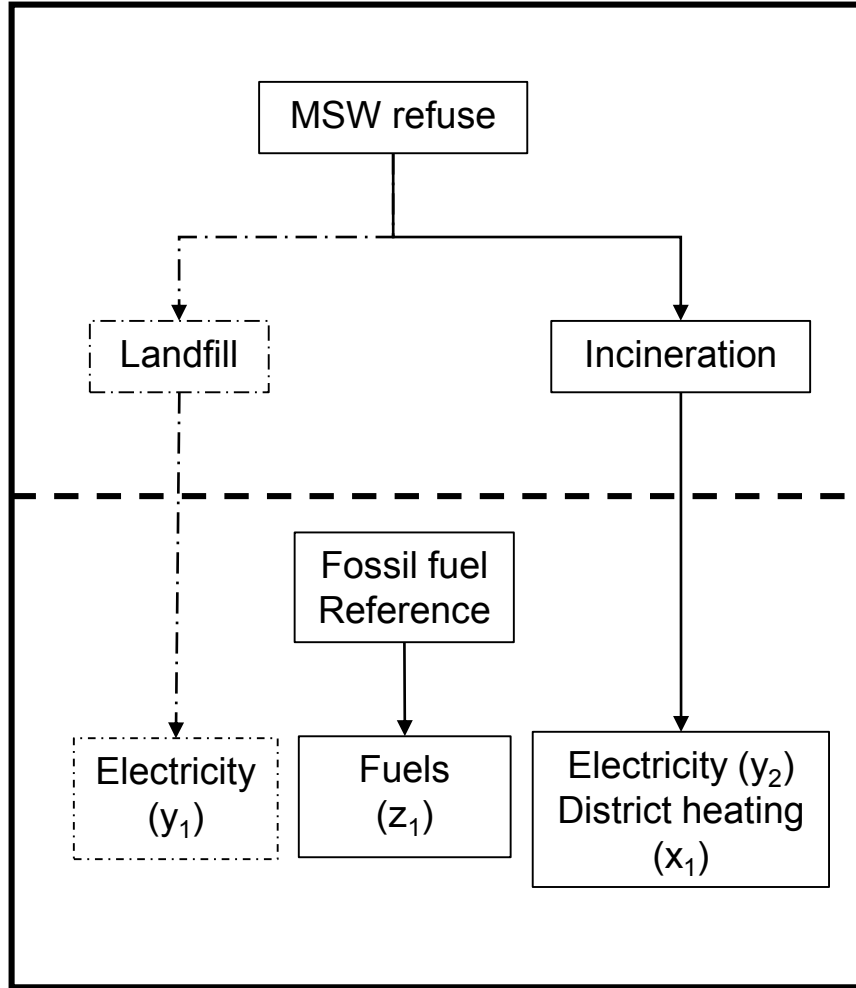

BIO SYSTEM

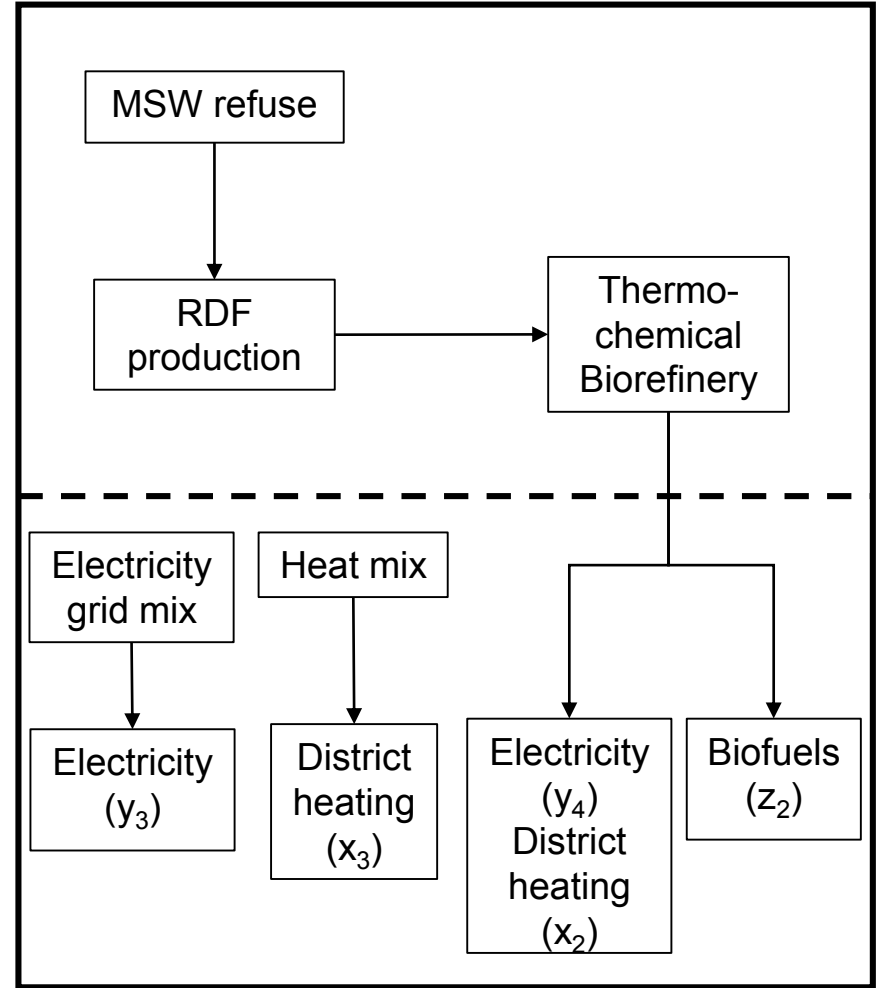

MSW

ENERGY

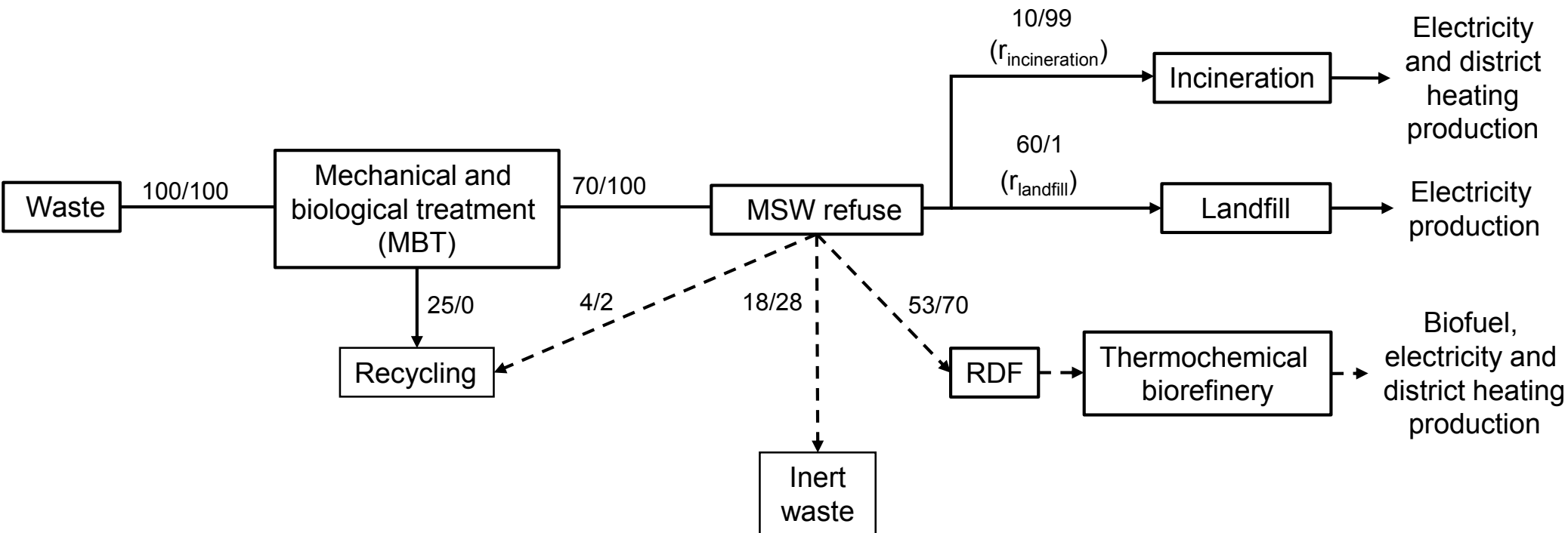

Spain/Sweden	mass fractions (%)
————	BAU system
- - - -	BIO system

Spain

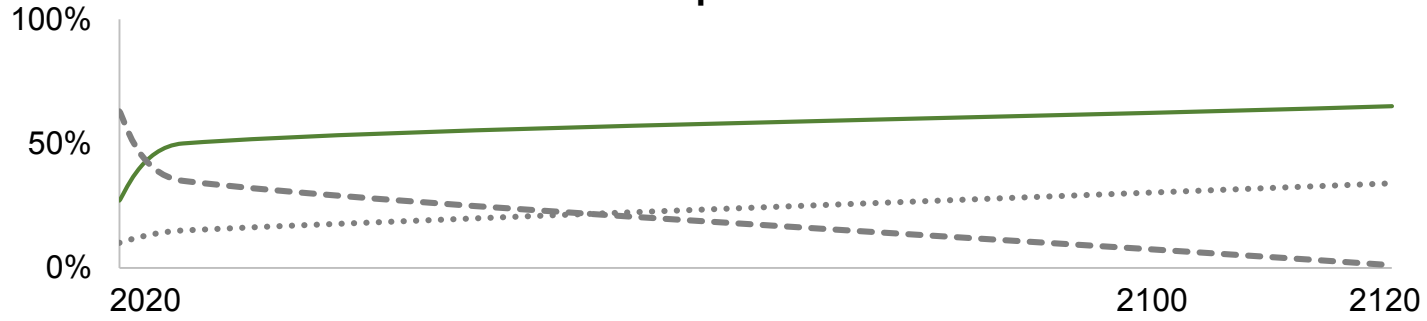

Sweden

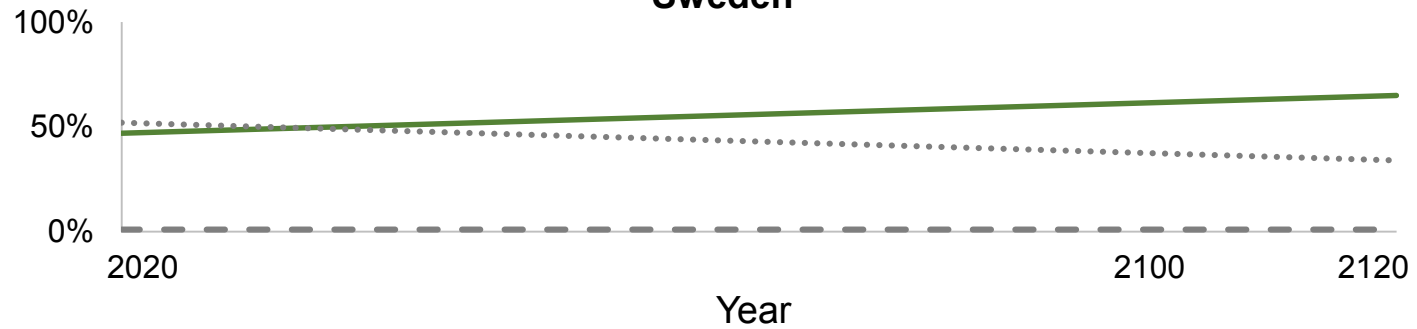

— Recycling (MSW) Incineration (MSW refuse) - - - Landfilling (MSW refuse)

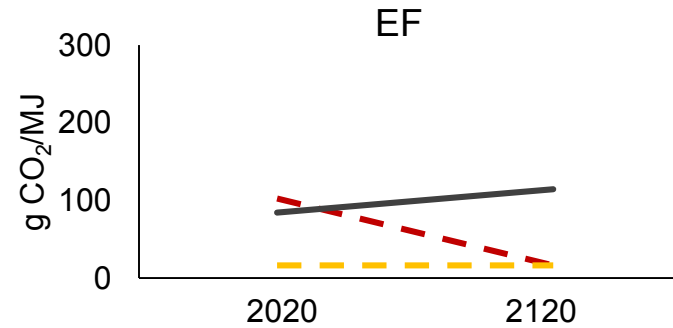
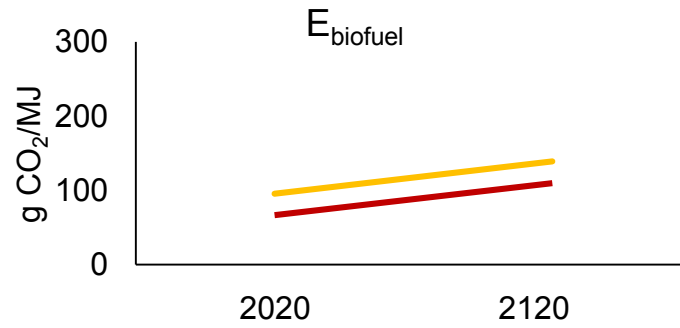
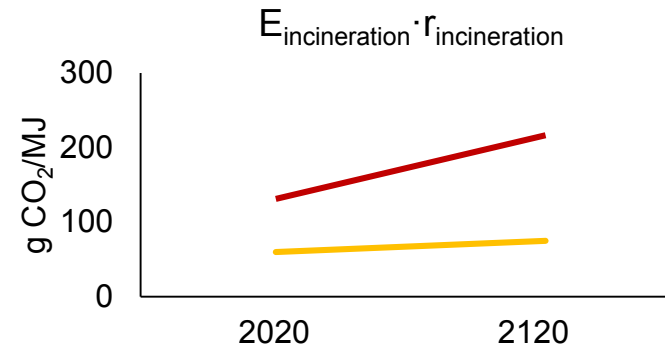
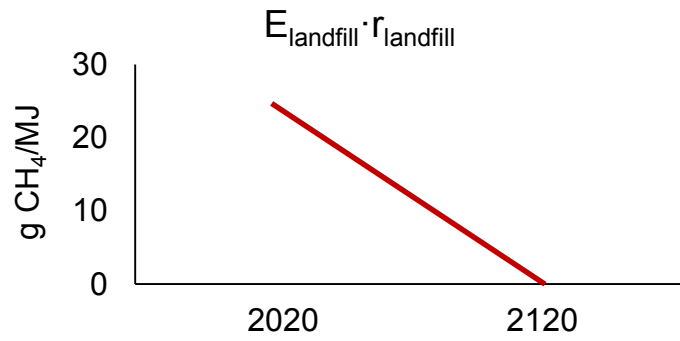

— Spain — Sweden

- - - Electricity Spain
 - - - Electricity Sweden
 — Fuels

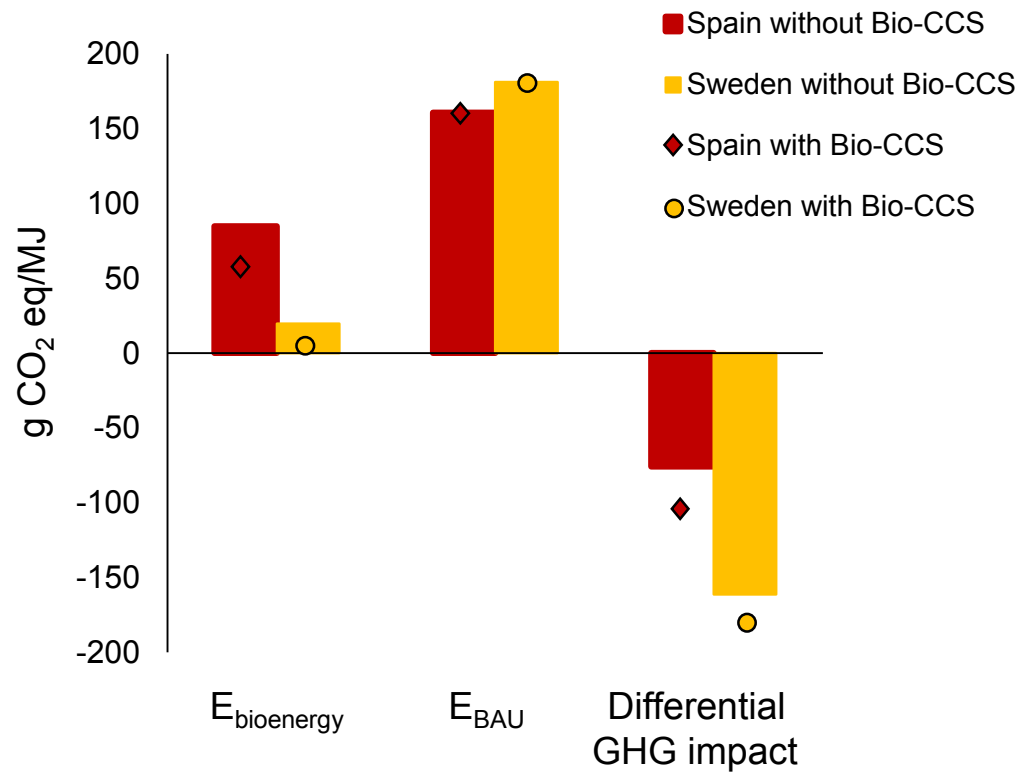

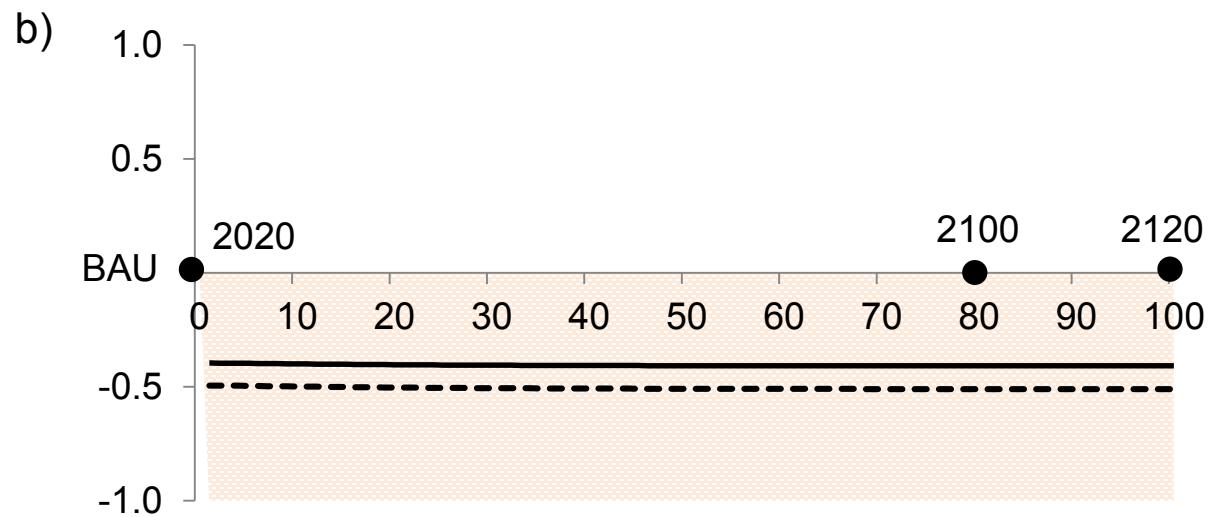
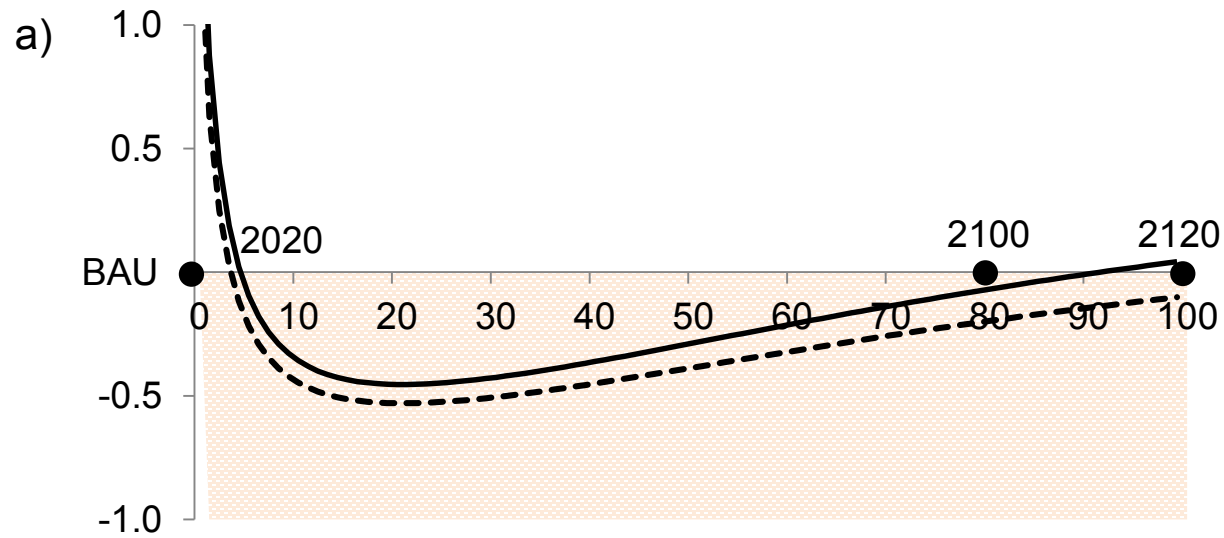

Below BAU — Without Bio-CCS - - - With Bio-CCS

