

# MANUFACTURING AND TESTING OF A CRUCIFORM COUPON FOR BIAXIAL TRANSVERSE TESTS

E. Correa, A. Barroso, S. Sánchez and F. París

Grupo de Elasticidad y Resistencia de Materiales, Escuela Técnica Superior de Ingeniería,  
Universidad de Sevilla  
Camino de los Descubrimientos S/N, 41092 Sevilla, Spain  
Email: ecorrea@us.es, web page: <http://www.us.es>

**Keywords:** Biaxial Testing, Cruciform Coupons, Composite Materials, Transverse Failure.

## ABSTRACT

The present study deals with the manufacturing of cruciform coupons to be tested under tensile biaxial transverse loads. The objective is to obtain a geometry that minimizes the effect of stress concentrations, maximizes the area subjected to biaxial loads and uniform it, and assures failure occurrence in this area.

The manufacturing process is described and the results of the transverse tests performed to check the validity of the geometry obtained are presented. The results confirm the adequacy of the manufactured coupons for the development of tensile biaxial transverse tests.

## 1 INTRODUCTION

The significant use of composite materials in the industry has been accompanied, during the last years, by an increase of the responsibility of these materials in the components they are part of. As a consequence, it seems essential to advance in the knowledge of the mechanisms of damage affecting these materials as well as in the prediction of their possible appearance.

This study focuses on the transverse failure, known as matrix/inter-fibre failure at lamina level, París et al [1]. This failure may appear in unidirectional laminates subjected to transverse loads or in multidirectional laminates subjected, for instance, to impact loads.

Transverse biaxial tests are planned on unidirectional laminates in order to study the generation and development of transverse failure. The objective is the clarification of the effect of a secondary tension superimposed on the tension nominally responsible for the failure; in particular, the conclusions derived from previous numerical studies by the authors (Correa et al [2]) want to be checked. The biaxial tests are thought to be performed by means of a mechanical device, designed and manufactured by the authors, adapted to a universal (uniaxial) testing machine, see Fig. 1 (Barroso et al [3]).



**Figure 1.** Device employed for biaxial tests.

In loading situations in which both transverse loads are tensile-type, the geometry of the coupon required for the development of the experimental tests needs to be cruciform in order to be able to introduce the load along two perpendicular axes. The design of this coupon was performed by the authors in a previous study using FEM models (Correa et al [4]), aiming to fulfil the following premises:

- Development of a uniform state of biaxial stresses on the coupon under testing.
- Maximization of the area subjected to biaxial loads.
- Minimization of the possible stress concentrations derived from the geometrical configuration.
- Failure occurrence in the zone subjected to a uniform state of biaxial stresses.

Coupon based on a preliminary cruciform design were already manufactured and tested (Barroso et al [5]), showing some problems that impeded the full achievement of the aforementioned premises. The objective of this paper is, based on the former numerical design [4] and experimental work [5], the manufacturing of a new cruciform coupon to be tested under biaxial transverse loads as well as the experimental checking of the adequacy of its geometry.

## 2 MANUFACTURING

The geometry of the coupon to be manufactured is based on the M2 model [4] (presented in Fig. 2).

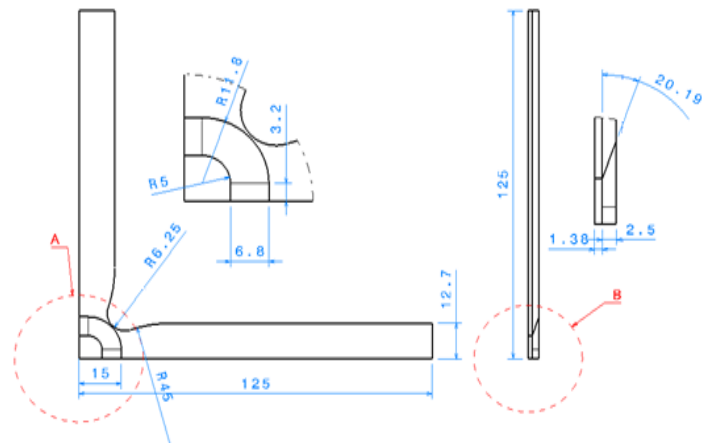
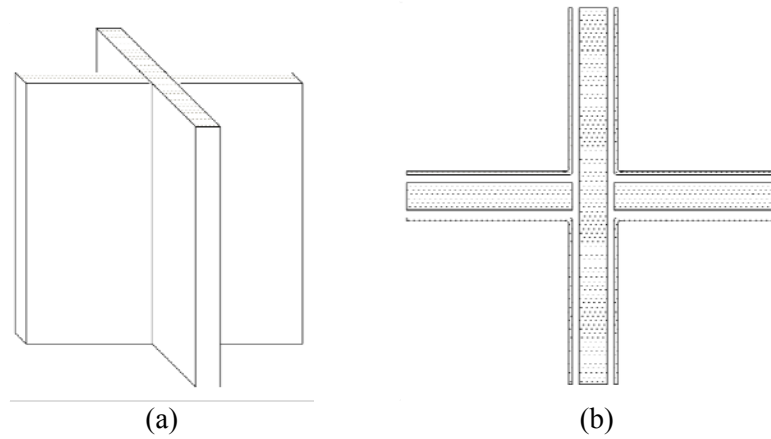

**Figure 2.** Geometry of the coupon to be manufactured.

In order to achieve the pursued geometry a cruciform prism is built, see Fig. 3a, and cured. After curing, the coupons are cut from the prism and later machined to obtain the final desired geometry, Fig. 2.

The set up of the cruciform prism, where the fibres follow the transverse direction, consist of several stages:

- 1) 108 carbon/epoxy pre-preg plies are laminated forming a 300x300 mm<sup>2</sup> unidirectional laminate.
- 2) The laminate is divided in two halves, and again, one of them in other two, resulting three laminates with the following dimensions: 300x150 mm<sup>2</sup> (vertical arm), 75x300 mm<sup>2</sup> (two horizontal arms), see Fig. 3b.
- 3) The cruciform prism is built using the three prepared arms.
- 4) Each side of the cruciform prism is covered with one single ply, see Fig. 3b, in order to prevent any possible defect during curing such as voids.
- 5) 4 aluminium blocks are employed to form a rectangular assembly that will maintain the cruciform shape during the curing stage, see Fig. 4 (picture taken before curing).



**Figure 3.** (a) 3D view of the cruciform prism, (b) Cruciform prism with outer plies.

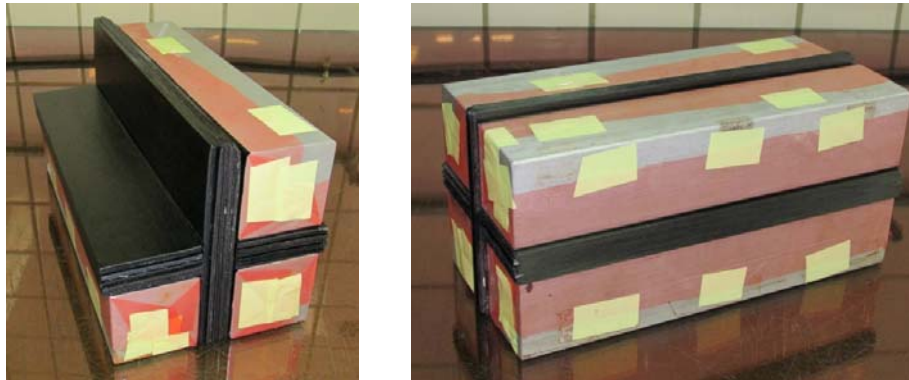
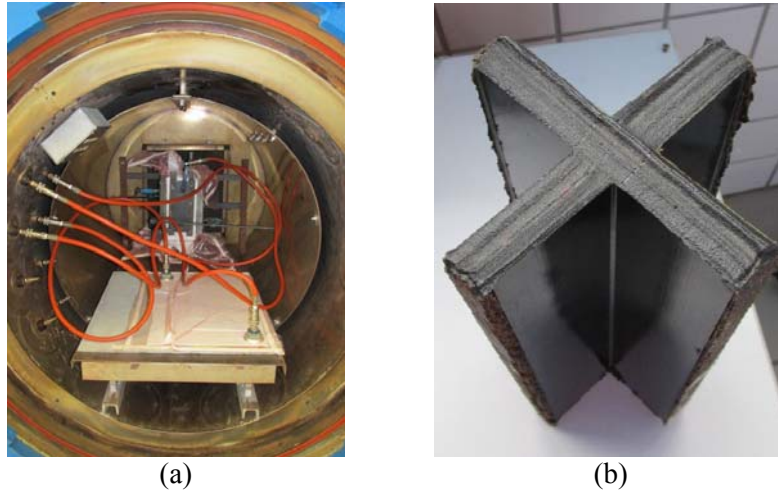

**Figure 4.** Rectangular assembly composed by the cruciform prism and the aluminum blocks.

Once the rectangular assembly is prepared a specially designed grip system is employed to avoid any possible misalignment of the prism arms during curing; this new system improves the previous one used in [5].

The whole system is inserted in a vacuum bag and introduced in the autoclave for its curing, Fig. 5(a). The curing cycle selected is described next:

- Heating from 25°C to 135°C in 1h20'.
- Maintaining at 135°C during 2h45'.
- Heating from 135°C to 180°C in 30'.
- Maintaining at 180°C during 3h'.
- Cooling from 180°C to 25°C in 53'.



**Figure 5.** (a) Cruciform prism introduced in the autoclave. (b) Cruciform prism after curing.

Once cured, Fig. 5(b), the cruciform prism is cut in slices using a water cooled diamond disk. The upper and lower faces of these slices are polished (Fig. 6a). The curved shape of the lateral surfaces (Fig. 2) is obtained by the machining of the slices using a metallic sample as master copy (Fig. 6b); this master copy has been previously manufactured by numerical control tooling. In a last step, the final central shape of the coupon (Fig. 2) is obtained also by means of numerical control tooling (Fig. 6c).

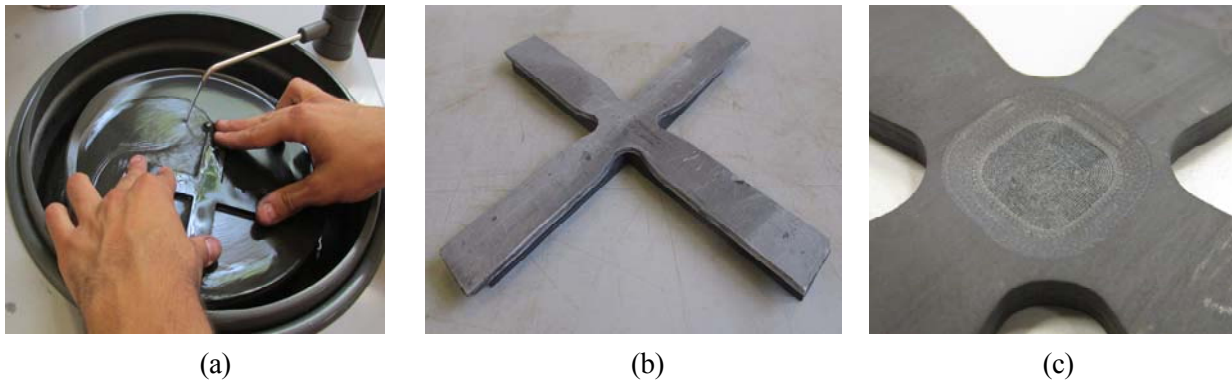

**Figure 6.** (a) Polishing of the upper and lower faces. (b) Metallic sample for the lateral faces machining. (c) Final geometry.

Additionally, observations with an optical microscope were performed in order to check if the manufacturing process had introduced any visible defects (voids, rich resin areas...) in the samples; no defects were detected, as shown in Fig. 7 where a 50x micrograph is presented.

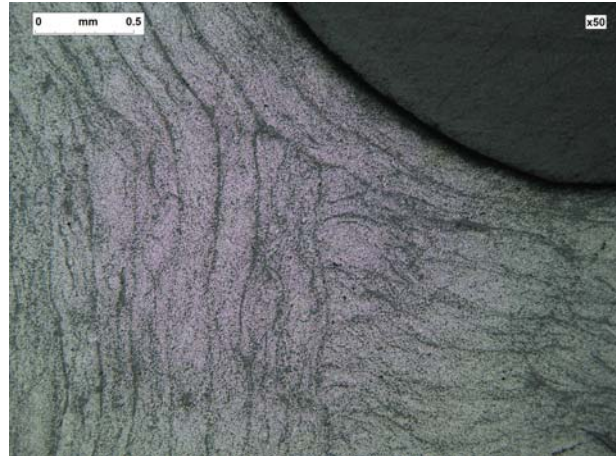

**Figure 7.** Micrography.

### 3 EXPERIMENTAL RESULTS

Uniaxial tensile transverse tests are performed both on rectangular coupons (Fig. 8a) and cruciform coupons (Fig. 8b). The objective is to check if the cruciform geometry fulfills the requirements detailed in the Introduction (uniform state of biaxial stresses, minimization of stress concentrations and adequate failure occurrence). To this end, the transverse strength under tension,  $Y_T$ , calculated independently for both sets of coupons, is compared, and failure location and morphology observed in the cruciform coupons.

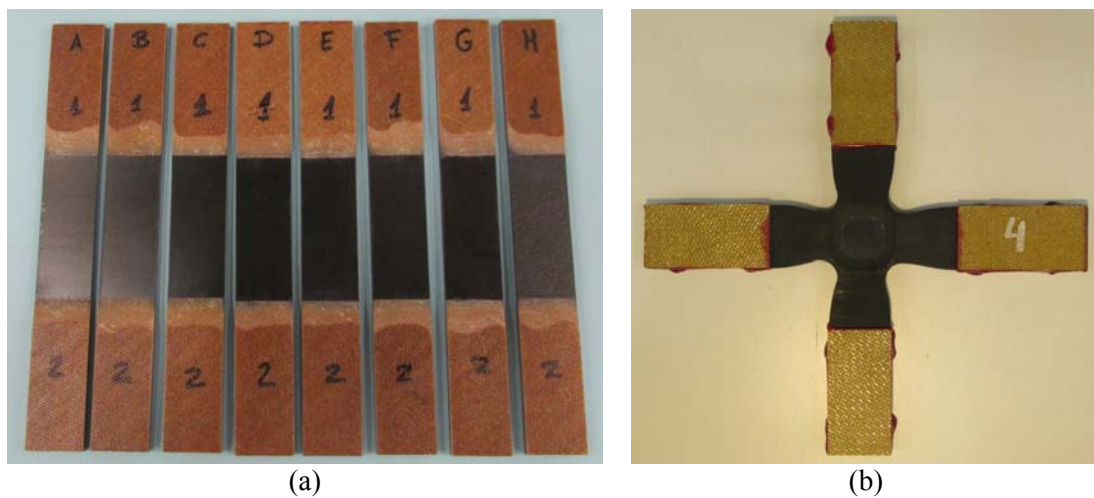

**Figure 8.** (a) Rectangular coupons. (b) Cruciform coupon.

8 rectangular coupons and 5 cruciform coupons were tested under transverse tension, see Fig. 8. The  $Y_T$  mean value and the variation coefficient (VC) of each set of coupons were calculated; in the case of the cruciform coupons the location of failure establishes the area to be employed in  $Y_T$  calculations.



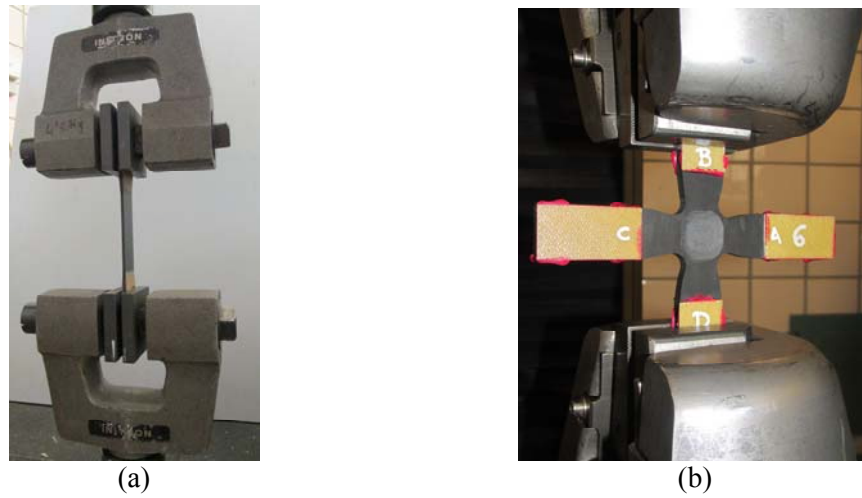

**Figure 9.** Uniaxial tests on a: (a) rectangular coupon (b) cruciform coupon.

The results obtained for both the rectangular set and the cruciform set are compiled in Table 1. It is first of all noticeable the low value of VC calculated for both sets, especially considering the usually relevant scatter appearing when testing transversely to the fibres. An excellent agreement is also found between the  $Y_T$  values of the rectangular coupons and the cruciform coupons.

| Coupon type | Mean value,<br>$Y_T$ (MPa) | VC (%) |
|-------------|----------------------------|--------|
| Rectangular | 54.77                      | 8.40   |
| Cruciform   | 58.35                      | 12.98  |

Table 1: Transverse strength ( $Y_T$ ) experimental results.

Additionally, and for the sake of completeness, the experimentally measured values of the transverse strength of each coupon,  $Y_{Ti}$ , are represented for both types of coupons in Fig. 10. As can be observed in that Figure, only 4  $Y_{Ti}$  values associated with cruciform coupons are plotted (as the test of one coupon was considered unsuccessful and therefore its corresponding  $Y_{Ti}$  value discarded).

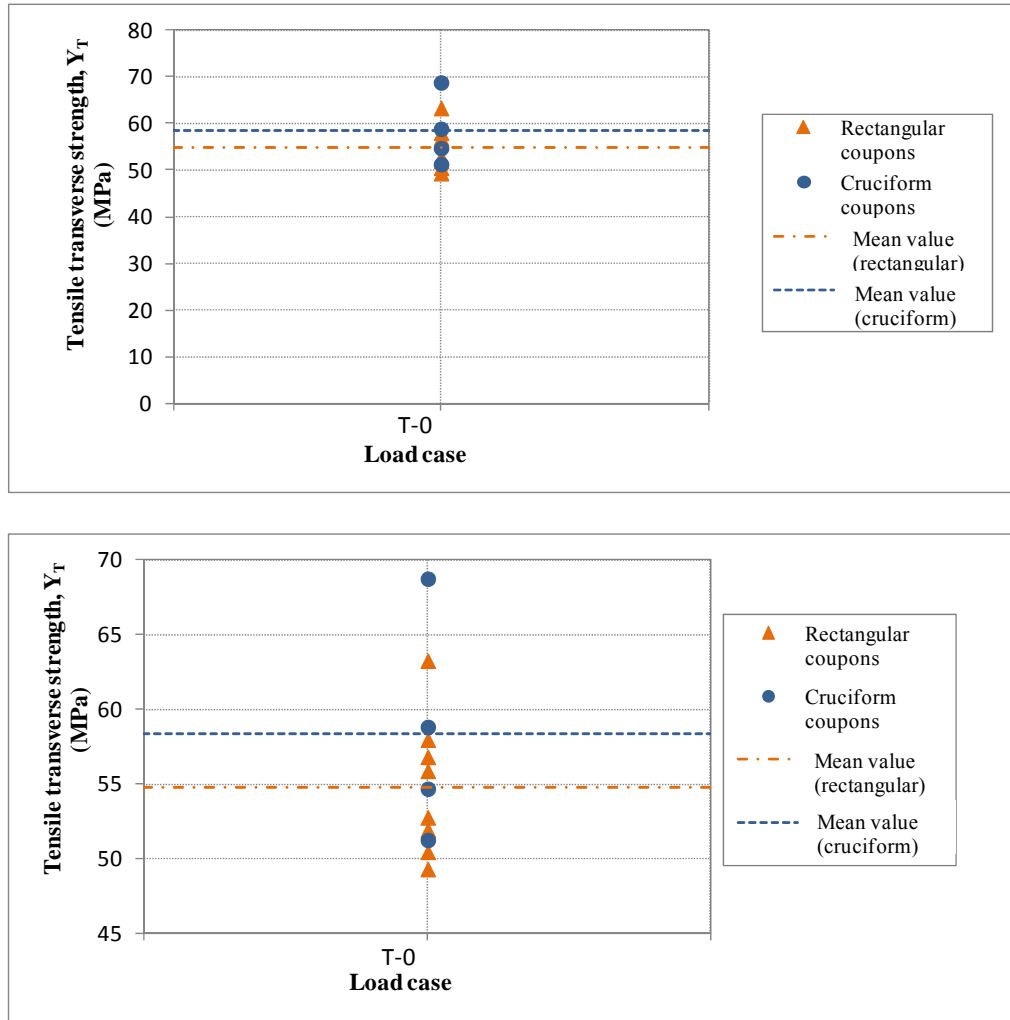

**Figure 10.**  $Y_{Ti}$  and  $Y_T$  values of rectangular and cruciform coupons.

With reference to failure morphology, it was also checked during the tests on cruciform coupons that, as desired, failure initiates at the central zone of the coupons in the direction perpendicular to the applied load, and progresses following the same direction until reaching the horizontal arms, see Fig. 11. This successful pattern is found in 4 of the 5 coupons tested; the other coupon corresponds to the discarded one as it broke out of the central zone.

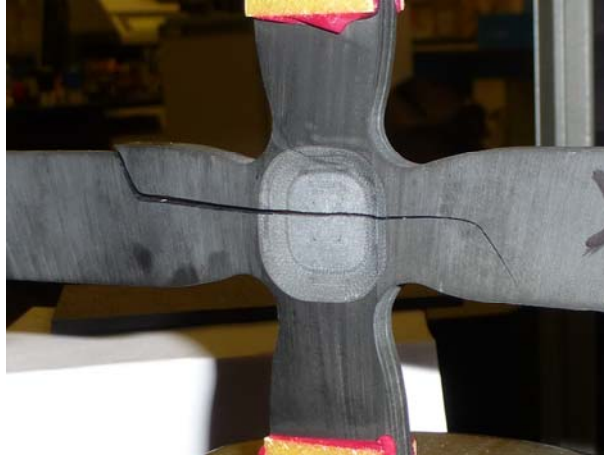

**Figure 11.** View of the failure in a cruciform coupon.

Finally, the results obtained associated with failure morphology of cruciform coupons and strength values comparison show that the cruciform geometry manufactured in this study is adequate for biaxial testing under tensile transverse loads.

## 9 CONCLUSIONS

The objective of this study was the manufacturing of a cruciform coupon, based on the geometry proposed in [4], adequate for the performance of tensile biaxial transverse tests.

Cruciform coupons were manufactured and the results of uniaxial tests have made it possible to check the validity of both the design and the manufacturing process.

Biaxial tensile tests using this validated geometry are currently in progress.

## ACKNOWLEDGEMENTS

This study was supported by the Spanish Ministry of Education and Science/Economy and Competitiveness and Junta de Andalucía (Projects MAT2013-45069-P, DPI 2012-37187 and P11-TEP-7093).

## REFERENCES

- [1] F. París, E. Correa and V. Mantič, Kinking of transverse interface cracks between fibre and matrix, *Journal of Applied Mechanics*, 74(4), 2007, pp. 703-716.
- [2] E. Correa, F. París and V. Mantič, Effect of the presence of a secondary transverse load on the inter-fibre failure under tension, *Engineering Fracture Mechanics*, 103, 2013, pp. 174-189.
- [3] A. Barroso, E. Correa, J. Freire, M.D. Pérez and F. París, Biaxial testing of composites in uniaxial machines: manufacturing of a device, analysis of the coupon geometry and preliminary experimental results, *Proceedings of the 15th European Conference on Composite Materials, Venice, Italy, June 24-28, 2012*.
- [4] E. Correa, A. Barroso, M.D. Pérez and F. París, Design of a cruciform coupon for biaxial transverse tests, *Proceedings of the 10th National Conference on Composite Materials (MATCOMP13), Algeciras, Spain, July 2-5, 2013*.
- [5] A. Barroso, E. Correa, J. Freire, D. Vega and F. París Device for biaxial testing in uniaxial machines. Design, manufacturing and experimental results using cruciform specimens of composite materials, *Proceedings of the 10th National Conference on Composite Materials (MATCOMP13), Algeciras, Spain, July 2-5, 2013*.