

Received November 12, 2021, accepted November 24, 2021, date of publication December 6, 2021, date of current version December 17, 2021.

Digital Object Identifier 10.1109/ACCESS.2021.3133438

Optimal Location of Distributed Energy Resources Considering Investment Costs, Use of Resources and Network Constraints

CARLOS GARCÍA-SANTACRUZ¹, ALEJANDRO MARANO-MARCOLINI¹,
AND JOSÉ LUIS MARTÍNEZ-RAMOS¹, (Senior Member, IEEE)

Departamento de Ingeniería Eléctrica, Escuela Técnica Superior de Ingeniería, Universidad de Sevilla, 41092 Sevilla, Spain

Corresponding author: Carlos García-Santacruz (cgarcia20@us.es)

This work was supported by the CERVERA Research Programme of Industrial and Technological Development Centre (CDTI), Spanish, the Industrial and Technological Development Centre of Spain, through the Research Project HySGrid+, under Grant CER-20191019.

ABSTRACT The consideration of distributed energy resources as non-wires alternatives for the elimination of overloads and voltage problems poses new challenges for their location and management. Traditional location methodologies approach the problem from the distribution system operator perspective, who tries to correct overload and voltage outside margins while minimizing other possible negative impacts in the network. The approach presented in this paper also considers the investor's point of view, seeking the most appropriate technology alternative, the maximum use of the available resource, and the minimum investment. Those aspects are explicitly taken into account in the formulation of the model, which takes the form of a mixed-integer nonlinear optimization problem. The proposed methodology is tested in two different scenarios using the medium-voltage distribution system benchmark of CIGRE. The results show that the interests of the distribution system operator and the investors can be jointly satisfied, achieving an effective, safe and realistic integration of new distributed resources.

INDEX TERMS Distributed energy resources, distribution system operator, non-wires alternatives, renewable integration methods, optimal DER location, power systems.

NOMENCLATURE

SETS

- \mathcal{D} Set of D DERs, $d \in \mathcal{D}$.
- \mathcal{D}_i Subset of \mathcal{D} located at bus i .
- \mathcal{K} Set of K branches with edges (i, j) , $k \in \mathcal{K}$.
- \mathcal{K}_{i+} Subset of branches starting at bus i .
- \mathcal{K}_{i-} Subset of branches finishing at bus i .
- \mathcal{N} Set of N buses, $i, j \in \mathcal{N}$.
- \mathcal{T} Set of T periods, $t \in \mathcal{T}$.

PARAMETERS

- C_d Specific installation cost for resource d , on annual basis (€/MW).
- $M_{d,t}$ Generation profile for resource d during period t (pu).
- P_d^{max} Maximum installed capacity for resource d (MW).
- P_d^{min} Minimum installed capacity for resource d (MW).

The associate editor coordinating the review of this manuscript and approving it for publication was Hao Wang¹.

- V_i^{max} Maximum allowed value for voltage magnitude (pu).
- V_i^{min} Minimum allowed value for voltage magnitude (pu).
- R_k Resistance of branch k (pu).
- X_k Reactance of branch k (pu).
- $P_{i,t}$ Net active power consumption at node i during interval t (pu).
- $Q_{i,t}$ Net reactive power consumption at node i during interval t (pu).
- I_k^{max} Maximum value of current magnitude for branch k .
- α Weight factor related to the use of the resources.
- β Weight factor related to the cost of energy losses.
- Π_t Cost of energy losses in interval t (€/MWh).

VARIABLES

- $p_{0,t}$ Active power injection from the primary substation in interval t (pu).

$q_{0,t}$	Reactive power injection from the primary substation in interval t (pu).
$p_{d,t}$	Active power injection by resource d in interval t (pu).
$q_{d,t}$	Reactive power injection by resource d in interval t (pu).
p_d^{ins}	Installed capacity for resource d (MW).
$p_{k,t}^f$	Active power flow through branch k in interval t (pu).
$q_{k,t}^f$	Reactive power flow through branch k in interval t (pu).
$z_{1,2,3}$	Objective values.
w_d	Installation cost for resource d (€).
f_d	Use factor for resource d .
$i_{k,t}$	Current magnitude squared through branch k in period t (pu).
$v_{i,t}$	Voltage magnitude squared in bus i in period t (pu).
u_d	Binary variable to indicate the installation of resource d .

I. INTRODUCTION

Recent reports, as [1], show the trend that will exist in the coming decades regarding the growth of electricity consumption, up to 40% in 2050 in the case of Europe [2]. In addition, the increasing electrification of mobility [3], [4], with a goal of zero emissions in 2050, will contribute to this increase. There are directives from some states and organizations, such as the European Union [5], which set a target of 32% electricity production with renewable energies, encouraging public and private investment in this sector.

The rise in renewable generation in medium voltage (MV) networks poses several challenges to the distribution system operators (DSO) which should prepare to face problems such as overloads in transformers or lines and excessive voltage deviations [6].

To solve these problems, there are two possibilities: investment in traditional solutions or considering non-wire alternatives (NWA), such as the location of distributed energy resources (DER) or management techniques.

In [7], a comprehensive review of planning expansion models and policy instruments is presented. Network expansion plans have been focused on traditional solutions for decades. Several studies analyze the expansion plans in different terms [8], [9]. The advantage of traditional solutions is that over the years they have proven to be reliable and effective, but they involve high costs, licensing problems, or even impossibility to carry out upgrades.

In the face of these disadvantages, NWA solutions can be considered [10]. As defined in [11], an NWA is the use of equipment or operation practices instead of undertaking network investment projects, which can solve network problems. This group of solutions includes the location of new DERs, or demand side management strategies (DSM), to manage and optimize energy consumption.

DSM solutions include Demand Response (DR). This is an alternative solution that avoids problems caused by the integration of distributed generation and is useful for deferring investments in the network [12], [13]. Despite its positive aspects, the implementation of DR can be complex and not accepted by users.

Several papers propose solutions based on the optimal location of DERs. In [14], a review of sizing and location methods of DERs is presented. Sensitivity analysis is used in [15] to size and locate the generic distributed generation. Work developed in [16] is another example of a method to optimize the size and location of DERs, to reduce investment and operation costs, using only photovoltaic (PV) generation. In [17], the objective is to optimize the location of distributed generation to minimize the energy losses of the system, but without considering the cost of the solutions or the type of DER to be installed. The research in [18] seeks to locate different types of distributed generation to minimize power losses, but without considering installation costs. The work in [19] approaches the optimal location only from a technical point of view, minimizing voltage deviations. The location problem can also be addressed with a multi-objective optimization, as in [20], where several objectives are valued.

Another approach to locate distributed generation is to use the concept of locational marginal value (LMV) [21] to quantify the value-to-the-grid of DERs. The most common way to find this value is through local marginal prices (LMPs) [22]. In [23], using the distribution LMPs, a method to identify the short-term value of DERs in the network is proposed. This translates into identifying the necessary injections at the nodes, and therefore the location of DERs, to correct overloads. A similar work has been developed in [24]. These approaches using LMPs have the disadvantage of being invariant to the type of DER technology and cost, which is a handicap for a complete valuation.

Most of the methods presented in the literature focus on looking for solutions with value for the grid, which is the DSO perspective. However, issues of interest to investors, such as installation costs and the selection of the most appropriate technology, are not taken into account.

Another gap in these methods is that they do not implicitly analyze the use of installed resources (percentage of use or volume of injected energy). This means that the solutions obtained may not be cost-effective or feasible from the financial point of view. Moreover, only problematic hours are considered, and there is no explicit analysis of what happens to the installed DERs the rest of the time. This can cause problems in unexpected periods when their performance is not analyzed.

This work attempts to fill these gaps. Therefore, the motivation is based on integrating DERs safely, considering their operation for the entire period analyzed, and not only when there are punctual problems. In addition, the interests (vision) of who decides to invest in the resources are also considered. The proposed methodology is based on the installation of DERs to ensure compliance of the network constraints within

the admissible values, also evaluating the cost, type of technology, and the use of the resource over time.

As main contributions of this work and innovations, the following points can be highlighted:

- The proposed methodology considers the DSO view together with the investors' perspective for the location of resources. Realistic solutions are achieved for both, avoiding marginal use of DERs.
- The integration of resources is contemplated for the entire period analyzed, resulting in an effective and complete integration, avoiding possible problems with the new DERs that are installed.
- It is possible to control the energy integration by node and DER technology through the definition of the DER use factor and its weighting.
- A global view of the best location for new DERs is attained by combining the use factor, the cost of the installation, and the type of technology in a single optimization problem.
- The output of the methodology is a set of solutions, which define a region of equilibrium between the interests of the investors and those of the DSO.

The rest of the paper is organized as follows. Section II presents the proposed methodology, including the model formulation and important concepts. Section III introduces the scenarios on which the methodology will be tested, and Section IV presents the numerical results. The main conclusions are drawn in Section V.

II. PROPOSED METHODOLOGY

To install and integrate DERs, as well as to promote them as an alternative to traditional solutions (upgrading lines, transformers, or adding new devices), it is necessary to ensure profitability for the investors. Furthermore, the DSO must also benefit from the DERs, or at least not be affected by their installation. Distributed generation tends to decrease the grid losses, but after a certain amount of injected energy, the network losses can increase again and new problems could appear, such as overload or voltage values out of limit.

The proposed methodology can be used by the DSO and by the investors, if they have the necessary data (consumption profiles, grid parameters. . .). Investors can analyze the best investment options (in terms of use, cost, and technology), considering different scenarios raised by the DSO. On the other hand, the DSO can also use the tool to analyze what are the best DER options to solve network problems, and which technologies are best integrated into the network.

Fig. 1 shows an overview of the proposed methodology, indicating the investor's interests and those of the DSO, the data needed as input, and the results generated. The DSO's perspective is analyzed in Section II-A. It explains how the DSO seeks to solve network problems through the optimal location of DERs. In Section II-B, the optimal location problem is approached from the investor's point of view, who attempts to make the investments profitable by maximizing

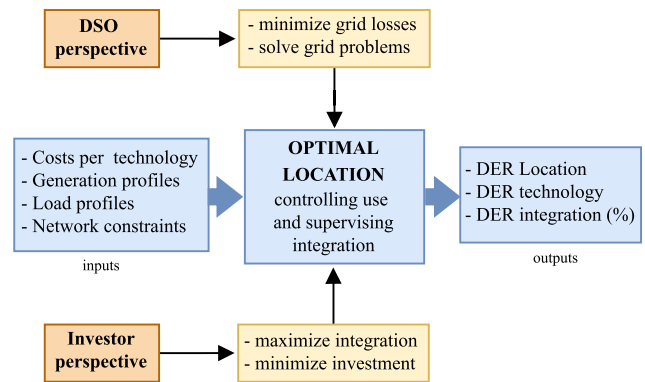

FIGURE 1. Flowchart of the proposed methodology.

the injected energy. Finally, Section II-C presents the complete model, in which the optimal location is defined in a single optimization problem taking into account the interests of the investors and the DSO, looking for location advantages for both.

A. DSO PERSPECTIVE

The DSO seeks to know the location and necessary power to be injected at problematic hours to solve the problems in the network, for example, overload in lines or out-of-limit voltage values, without having to make new investments in the grid.

To do this, an optimization problem is posed, defining restrictions that allow the voltage or current values to be kept within the admissible values, that is, to correct quantities that are out of range. The analysis covers a time horizon, which can be considered a reliable scenario of what is happening on the network. The objective function of this DSO optimization problem pursues additional benefits with the use of DERs, such as minimizing the amount of energy losses or other operating costs.

An objective function that tries to minimize the cost of energy losses in the network is proposed, thus reflecting the interest of the DSO. This function is defined as:

$$\min z_1 = \sum_t \Pi_t \cdot \left(p_{0,t} + \sum_d p_{d,t} - \sum_i P_{i,t} \right), \quad (1)$$

where the decision variables are the location and magnitude of the power injections for each hour of the analyzed time horizon. In Section II-C, this objective function is combined with the one reflecting the investor's perspective. The merged objective function together with the necessary constraints, define the optimization problem.

B. INVESTOR PERSPECTIVE

An investment in DERs, to be profitable, requires the facilities to participate in energy markets and rewarded ancillary services. Not all locations in a MV network have the same capacity to evacuate the energy produced and withstand power injections. In the case where DERs are also installed to solve problems in the grid, the question is whether the investment will be returned. This point is fostered by selecting the options

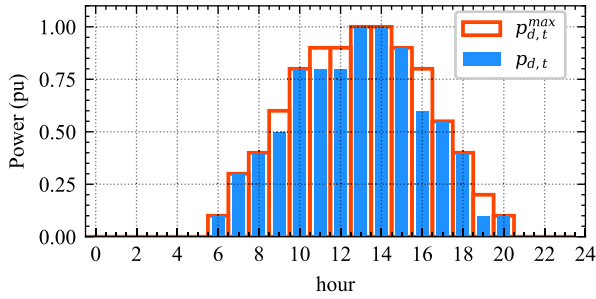

FIGURE 2. Example of a PV generator indicating available energy (red) and injected energy (blue) with curtailment at certain times.

with lower costs and the highest use of resources during the entire period analyzed.

The installation cost of a generation resource d depends on the location, the technology of the resource, and the installed capacity. It is computed as:

$$w_d = C_d \cdot p_d^{ins} \quad \forall d \in \mathcal{D}. \quad (2)$$

The set \mathcal{D} has cardinality $n \times i$, where n is each of the types of technologies considered. All buses are candidates to install DERs with different technologies, and the optimization problem decides which option is better for each location. The parameter C_d can include, in addition to the fixed costs, the purchase cost of land and licenses.

One way to effectively integrate resources into the grid is to define a use factor, which accounts for the degree of utilization of the resource with respect to the maximum potential use. The reason this use factor is defined in terms of active power is due to the fact that the sale of active power is considered the main business to obtain profitability, so it is a good indicator to associate use and profitability. Since the installation cost ratio per MWh injected is decreased, it can be said that the higher the degree of utilization, the more profitable the investment is.

The use factor is defined for each DER d as:

$$f_d = \frac{\sum_t p_{d,t}}{\sum_t M_{d,t} p_d^{ins}} \quad \forall d \in \mathcal{D}, \quad (3)$$

where the numerator is the injected energy, and the denominator is the potential injected energy during the analyzed period. With this factor, it is possible to compare DERs with different capacities and technologies. Generation profiles ($M_{d,t}$) are specific for each candidate resource d , this implies that the profiles are different for each node and primary energy source.

The maximum energy available in a period depends on the type of resource. As shown in Fig. 2, in a PV generator, where the available energy changes every hour, there might be forced curtailments that hamper the injection of all available energy.

The optimal location problem, as seen from the owner's point of view, is based on boosting the use of resources, through the use factor, for all life of the facilities, including problematic periods. The inclusion of the use factor makes it

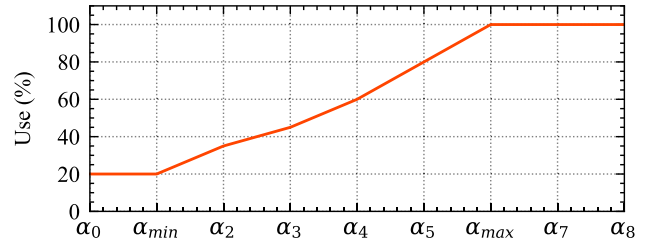

FIGURE 3. Evolution of the use factor as a function of α , indicating minimum and maximum values.

easier to decide which type of resource is the best option to install economically and in terms of use, opting for less costly solutions. The use factor seeks to penalize the most expensive and least used solutions. This problem can be formulated using the following objective function:

$$\min z_2 = \sum_d w_d \left(1 + \alpha \frac{\sum_t M_{d,t} p_d^{ins} - p_{d,t}}{1 - u_d + \sum_t M_{d,t} p_d^{ins}} \right), \quad (4)$$

where u_d is a binary variable which is 1 when generator d is installed. It has to be included in (4) to prevent the denominator from being zero when no DER is installed.

The parameter α weights the importance given to the use factor in the location problem. By modifying this parameter, it is possible to achieve different percentages of the average use of the DERs obtained as a solution to the optimization problem.

When a large α is defined, high levels of DERs will be integrated. An excessive integration could cause problems in the network, such as an increased level of energy losses. If α is small ($\alpha \simeq 0$), there would be a risk of selecting DERs with a very low use factor, injecting power only during the few hours needed to avoid problems; this could be good for the grid operator, but not for the owners of the generators.

The mechanism to tune α for a particular network and scenario consists in finding the smallest value for which the use is 100% and the highest value for which the use factor can not be lowered. An example is shown in Fig. 3, where these values are defined as α_{max} and α_{min} , respectively. Between α_{min} and α_{max} the evolution of use factor is not linear due to the influence of reactive power injection in the system.

The use factor is a key concept to consider when the location of DER is analyzed, leading the optimization problem to beneficial solutions for the investor.

Nevertheless, the location based only on the interests of the owner has the disadvantage that uncontrolled integration can cause problems to the network. This is why a methodology that provides a safe and effective integration is needed.

C. COMBINED PERSPECTIVE

After defining the optimal DER location for owners and DSO individually, the optimal location model that covers both views is presented. This model is valid for all types of networks, however, in the following it will be assumed that the networks are radial and balanced.

This methodology is based on favoring the use of DERs during the lifetime of the installations, including problematic hours, but controlling that they do not cause problems in the grid, due to the power injections of the new located resources.

The approach is formulated as a mixed-integer nonlinear programming problem (MINLP), composed of the combination of the objective functions (1) and (4). In addition, the AC OPF model [25], used in other location methods, has been used as a reference to define network constraints. The objective function is defined as:

$$\min z_3 = \beta \cdot z_1 + z_2, \quad (5)$$

where β is a weight factor related to the cost of energy losses. With this parameter, the DSO can assess the importance of the cost of losses in the grid: setting a high value would mean that reducing the cost of losses is a priority. Therefore, modulating β , the location of distributed generation can be controlled or supervised, taking into account possible grid benefits.

The reason for formulating this problem as a single-objective optimization problem is because it gives more relevance to the owner's point of view (higher weight of the investment), but with the advantage that the DSO can condition the location (adjusting β) to make it beneficial and controlled.

The objective function of the full model is constrained by the following restrictions:

$$\sum_{k \in \mathcal{K}_{i-}} (p_{k,t}^f - i_{k,t} R_k) - \sum_{k \in \mathcal{K}_{i+}} p_{k,t}^f + \sum_{d \in \mathcal{D}_i} p_{d,t} - P_{i,t}^{load} = 0, \quad \forall i \in \mathcal{N} \setminus \{0\}, \forall t \in \mathcal{T} \quad (6a)$$

$$\sum_{k \in \mathcal{K}_{i-}} (q_{k,t}^f - i_{k,t} X_k) - \sum_{k \in \mathcal{K}_{i+}} q_{k,t}^f + \sum_{d \in \mathcal{D}_i} q_{d,t} - Q_{i,t}^{load} = 0, \quad \forall i \in \mathcal{N} \setminus \{0\}, \forall t \in \mathcal{T} \quad (6b)$$

$$v_{i,t} - 2(p_{k,t}^f R_k + q_{k,t}^f X_k) + (R_k^2 + X_k^2) i_{k,t} = v_{j,t}, \quad \forall k \in \mathcal{K}, \forall t \in \mathcal{T} \quad (6c)$$

$$v_{i,t} \cdot i_{k,t} \geq p_{k,t}^{f2} + q_{k,t}^{f2}, \quad \forall k \in \mathcal{K}, \forall t \in \mathcal{T} \quad (6d)$$

$$i_{k,t} \leq (I_k^{max})^2, \quad \forall k \in \mathcal{K}, \forall t \in \mathcal{T} \quad (6e)$$

$$(V_i^{min})^2 \leq v_{i,t} \leq (V_i^{max})^2, \quad \forall i \in \mathcal{N}, \forall t \in \mathcal{T} \quad (6f)$$

$$P_d^{min} \cdot u_d \leq p_d^{ins} \leq P_d^{max} \cdot u_d, \quad \forall d \in \mathcal{D} \quad (6g)$$

$$p_{d,t} \leq M_{d,t} p_d^{ins}, \quad \forall d \in \mathcal{D}, \forall t \in \mathcal{T} \quad (6h)$$

$$-p_{d,t} \cdot \tan \varphi \leq q_{d,t} \leq p_{d,t} \cdot \tan \varphi, \quad \forall d \in \mathcal{D}, \forall t \in \mathcal{T} \quad (6i)$$

where $p_{0,t}$, $q_{0,t}$, $p_{d,t}$, $q_{d,t}$, p_d^{ins} , $p_{k,t}^f$, $q_{k,t}^f$, $i_{k,t}$, $v_{i,t}$ and u_d are optimization variables.

Equations (6a) and (6b) represent the active and reactive power balance at nodes, where the injections of the new distributed generation are included. Equations (6c) and (6d) define the voltage at nodes and the currents through the branches respectively, while (6e) and (6f) define the voltage and current limits.

The equation (6g) defines the minimum and maximum power that can be installed. The active power limits are defined in (6h), where the maximum power to be injected is

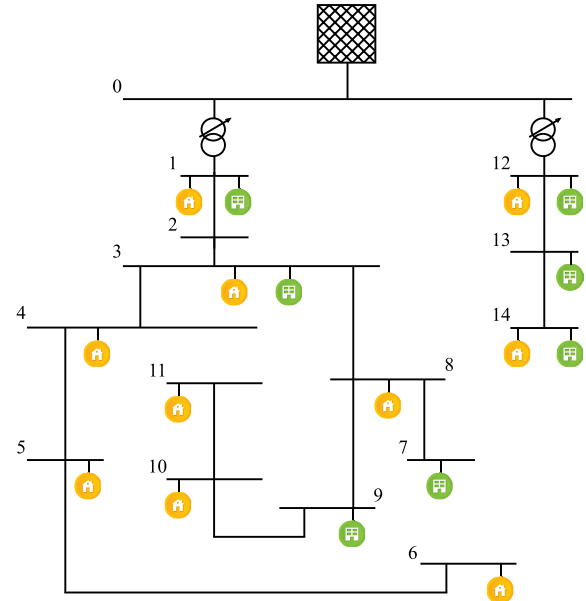

FIGURE 4. MV distribution network benchmark from CIGRE.

restricted to the maximum available power, determined each hour by the generation profile, M_d . Finally, the maximum and minimum reactive power limits are defined in (6i).

In summary, the optimal location problem that integrates the view of the distributed generation owners and the grid manager is obtained by solving the MINLP optimization problem: (5), subject to (6a)-(6i).

This model makes it possible to locate DERs that solve problems and are integrated into the grid without causing new problems, even though they can inject almost all available energy (no curtailment). This is achieved by identifying the best type of resource based on cost and use (owner perspective). At the same time, the DSO can supervise that the new DERs do not cause problems or excessively increase the energy losses.

III. TEST SYSTEM

The proposed methodology will be tested on the MV distribution network benchmark of CIGRE (European configuration), shown in Fig. 4. Data relating to nominal power, location, and type of load and generation are reported in [26].

Both feeders have a nominal voltage of 20 kV, with admissible voltage limits between 0.95 and 1.05 pu, a base power of 10 MVA and a base current of 288.6 A. The ampacity ratings of the branches are shown in Table 1.

Three different load types are used: residential, commercial and industrial. Load profiles are shown in Fig. 5. Industrial loads have the same location and power ratings as commercial loads in [26]. In addition, there are four types of DERs on the grid: PV, diesel, fuel cell and wind generators. The profile of each one is shown in Fig. 6.

Three cases with different types of loads are defined. The DER profiles, location and nominal power are kept the same in both. The aim is to consider scenarios with voltage and/or

TABLE 1. Branch ampacity ratings.

Branch	A	Branch	A	Branch	A	Branch	A
0-1	730	3-4	145	8-7	145	12-13	195
0-12	730	4-5	145	8-9	145	13-14	195
1-2	130	5-6	145	9-10	145		
2-3	130	3-8	145	10-11	145		

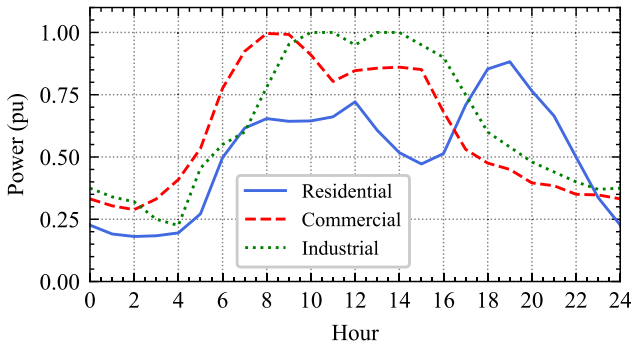

FIGURE 5. Evolution profiles for each type of load.

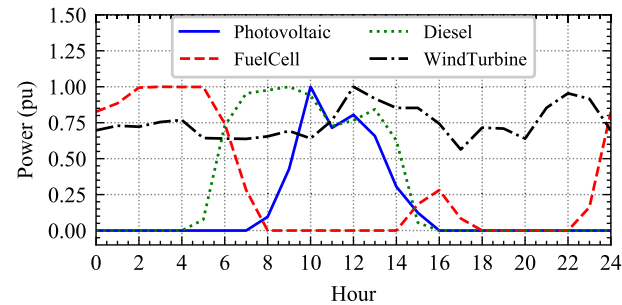

FIGURE 6. Generation profiles for each type of DER.

current limit violations in some periods, and assess how these problems are managed with the proposed methodology.

Several profiles could be used, representing different seasons or periods of time. However, for simplicity, a profile that represents a typical day is used for this analysis.

A. SCENARIO A

In this scenario, there are residential and commercial loads at the corresponding nodes. With the original data, there are no overload or voltage problems in the network, so it is necessary to scale the nominal power of the loads to create them.

The consumption of node 1 is increased by 60% and node 12 by 70%. With these increases, peak currents of 814.9 A occur on branch 0-1, while on branch 0-12 the maximum current reaches 808.5 A, exceeding the maximum limit for both branches. In addition to these overload problems, there are voltage values below the admissible range, with a minimum of 0.938 pu at node 11. Generic DERs with installation costs of 2000 €/kW are used as candidates to solve these problems.

B. SCENARIO B

In scenario B, there are only loads with industrial consumption profile, located at the same nodes and with the same rated power as commercial loads. As in the scenario A, the loads have to be scaled to create problems in the network.

All loads triple their value, except for the loads of node 1 and node 12, which increase by a factor of 3.25. With these values, overloads occur on branches 0-1, 0-12, 1-2 and 2-3. On branches 0-1 and 0-12 the peak currents are of 812.1 A and 768.9 A, respectively. In branches 1-2 and 2-3 the limit of 130 A is exceeded, with a maximum value of 132.12 A for both of them. The values of voltage at nodes also present problems, at node 10 there is a minimum value of 0.905 pu, below the admissible limit of 0.95 pu.

For this scenario, both wind and PV generation are candidates for installation, with the profiles shown in Fig. 6. To define their costs, [27] is taken as a reference, where an installation cost of 1473 €/kW for onshore wind generation is defined, while for PV generation the cost is 995 €/kW.

C. SCENARIO C

Scenario C includes residential and commercial loads. This scenario will be used for comparison with an alternative method [23] proposed in the literature. The objective is to demonstrate the advantage and functionality of controlling the use of resources through the use factor, and its weighting with α .

As in previous scenarios, the loads have to be scaled to create overload problems: the loads of node 1 and 12 are increased by a factor of 1.5 and 2, respectively. With these values, overloads appear on branch 0-1, with a peak current of 767.88 A, and branch 0-12, with a peak current of 972.83 A. Because it is compared to a method based on LMPs, generic generators will be used as in scenario A.

IV. RESULTS

This section presents the results of applying the proposed methodology to the network and the scenarios described above. In the first scenario (scenario A), the results of integrating generic DERs, which also correct the problems present in the network, are analyzed. In the second scenario (scenario B), specific DERs are used, either for PV or wind generation, for the location and correction of problems.

To analyze the proposed method, two cases are compared. One of them with a non-zero α , which means taking into account the use of the resources; while the other case with $\alpha = 0$, which means not considering the use factor.

A. SCENARIO A

The objective is to correct, using generic DERs, the overload and voltage problems in the system, as well as to integrate the power injections of these DERs into the grid. To assess the influence of considering the use factor, the model will be applied with $\alpha = 0.003$. Coefficient β is defined equal to 1, to take into account the importance of reducing the cost of energy losses in the solution.

Fig. 7 shows the location and size of DERs for both values of α . It is observed that despite the fact that the same nodes are chosen, the installed capacity differs in each one. These differences are due to the use factor, which allows more capacity to be installed when the resource use is high.

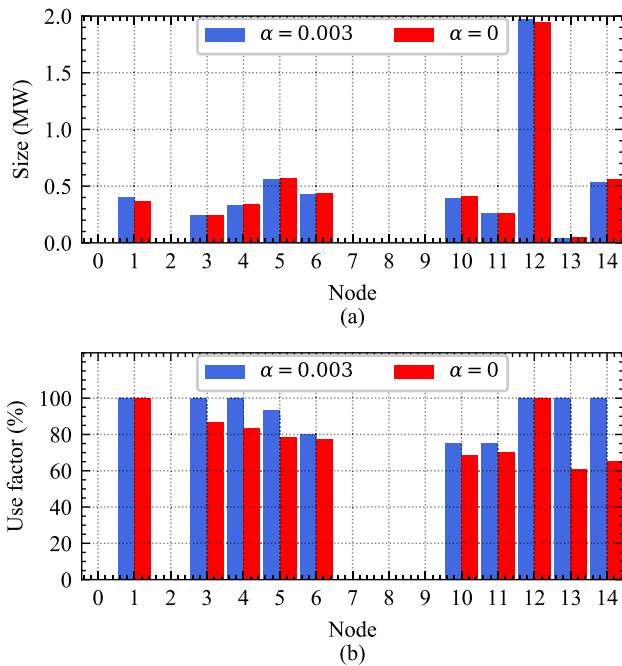

FIGURE 7. (a) Location and size of the installed generic DERs and (b) use factor of the selected DERs.

TABLE 2. Results of two cases presented for scenario A.

α	Investment (M€)	Total energy injected (MWh)	Specific Cost (€/MWh)	Use (%)
0.003	10.346	117.30	16.11	94.47
0	10.346	106.73	17.70	85.98

At node 1, 0.4 MW is installed for the case of $\alpha = 0.003$, while 0.37 MW is installed for $\alpha = 0$. The increase is motivated by the fact that 100% of use is reached, so a higher investment is justified, since it would be profitable. However, at node 14 the situation is the opposite, without controlling the use, more power is installed: 0.56 MW compared to 0.53 MW in the case of considering the use, which means a difference in investment of an additional 60 k€.

This emphasizes one of the advantages of the proposed methodology: the size is reduced, which means a lower investment, making the most of the DER capacity and avoiding overloads and voltage problems. The owner is doubly benefited, reducing his investment and increasing the volume of injected energy into the grid. As $\beta = 1$ was defined, the DSO also benefits since losses are reduced.

A summary of the two cases presented is shown in Table 2. Although the investments are similar, the installed capacity at the nodes is different, with an increase of 10% in average use, 94.47% versus 85.98%. This has an impact on the average ratio between installation costs and MWh injected, with an average energy specific cost of 16.42 €/MWh enhancing the use, and 17.70 €/MWh not considering the enhancement. In other words, for an integration rate of 94.5%, the installation cost per MWh is reduced by 8.99%, a result that benefits all grid agents.

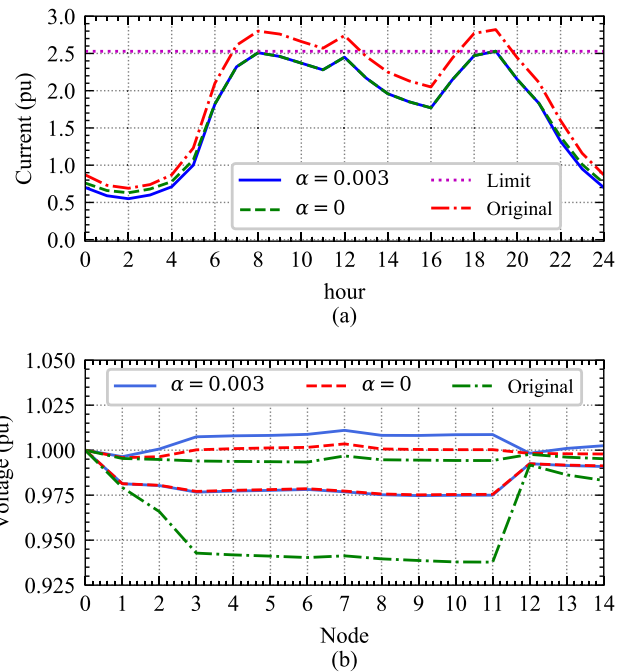

FIGURE 8. (a) Current evolution on branch 0-1, and (b) maximum and minimum voltage for each bus.

Fig. 8 shows the overload and voltage corrections made in the problematic hours. The currents that were originally above the limits are now within the admissible values. The same occurs with the voltage, where the minimum values, which were below 0.95 pu, are now around 0.975 pu. The current in branch 0-1 has a very similar profile in both cases, with values below the admissible limit of 2.53 pu, reaching this value only in hour 19.

Table 3 shows the results obtained in this scenario when the value of α is varied. DER integration is defined as the percentage of injected energy by DERs with respect to the total energy absorbed by the load. The average specific cost is the ratio between the installation cost and the injected energy by the DER. These figures draw a region of equilibrium between the interests of the investor and those of the DSO. The adopted solution should be negotiated between both parties according to their requirements.

Comparing the alpha values, it can be seen that in the interval between $\alpha = 0 = 0$ and $\alpha = 3e-3$, the reduction in energy losses is similar, but for higher values of α , the reduction is lower. This is the case of $\alpha = 9e-3$, which achieves the maximum use and integration, where the reduction is at least 2% lower than in the other cases. Analyzing the cases shown for $\alpha = 0$ and $\alpha = 3e-3$, in addition to the cost reduction, with almost the same reduction in energy losses, an increase in DER integration of 1.13% is achieved.

Fig. 9 shows the loss reduction for different percentages of use when the DSO perspective is not considered for the location in this scenario ($\beta = 0$). It can be seen that depending on the average use (achieved defining different α values), the loss reduction is different.

TABLE 3. Comparison of results for scenario A varying the parameter α .

α	Average use (%)	Energy losses reduction (%)	DER integration (%)	Average specific cost (€/MWh)
0	85.98	25.96	11.51	17.70
1e-4	86.73	25.96	11.61	17.55
5e-4	88.81	25.93	11.89	17.14
1e-3	90.74	25.86	12.15	16.77
2e-3	93.04	25.68	12.45	16.36
3e-3	94.47	25.47	12.64	16.11
5e-3	97.08	24.80	12.99	15.68
9e-3	100	23.54	13.38	15.22

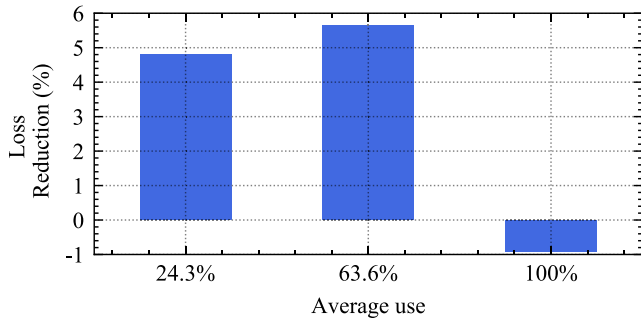

FIGURE 9. Loss reduction for different percentages of use setting $\beta = 0$.

For an average use of 63.6%, there is a greater reduction in losses than in the case of 24.3% average use. However, for 100% of use, the losses increase by 0.9%. This is an undesirable effect: despite the maximum use of DERs is achieved, the energy loss increases compared to the initial situation. This is one of the underlying reasons it is important to include the vision of the DSO.

B. SCENARIO B

In this scenario, the objective is the same as in the scenario A, but using PV and wind generation. To adjust the use factor in this case, $\alpha = 0.001$ is defined for the two types of generation to be installed, as well as a value of $\beta = 1$ to assess the importance of minimizing the cost of energy loss.

The results of the size and use of PV generation are shown in Fig. 10. The differences are greater than if generic resources were used, as in the case of nodes 13 and 14. At node 13, considering the use, 0.024 MW is installed, and 0.07 MW if it is not considered. The latter implies a higher investment and less profitability.

At node 14, when the use is increased, more PV generation is installed: 0.44 MW to 0.39 MW. A higher investment is made because it is profitable, as its utilization is 100%, while without enhancing it, it only reaches 77.3%. This means that, despite the higher investment, the average cost of installation per MWh injected will be significantly lower, so the higher investment is justified.

In the location of wind generation (Fig. 11), the differences in size are more significant. The clearest case is node 9, where the largest investment is made in both cases, 1.43 MW considering the use and 1.49 MW without considering it, which means a difference of about 90 k€. Average use increases by 4.31%, going from 42.61% for $\alpha = 0$ to 46.92% for the

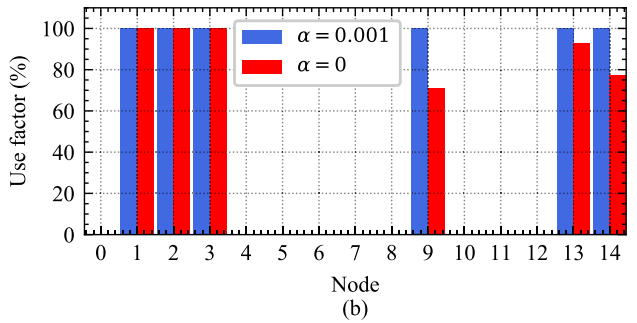
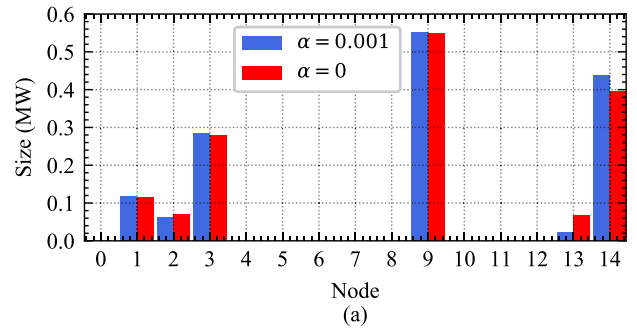

FIGURE 10. (a) Location and size of installed PV generation, and (b) percentage use factor.

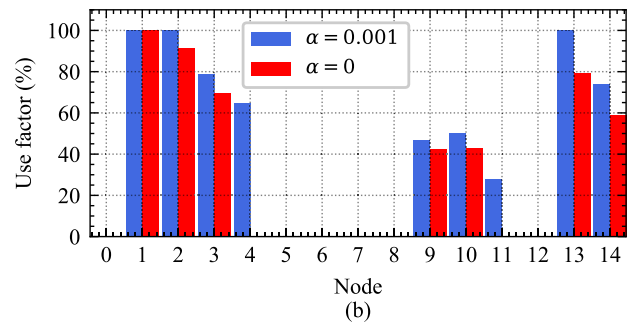
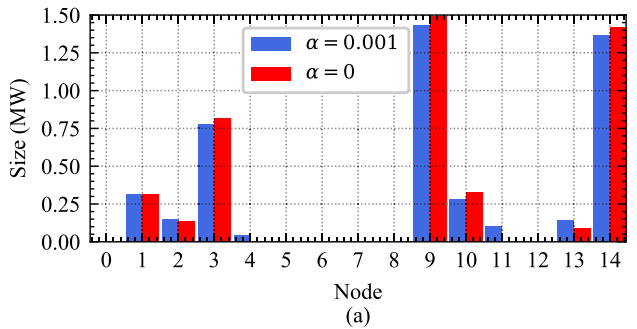

FIGURE 11. (a) Location and size of installed wind generation, and (b) percentage use factor.

case of $\alpha = 0.001$. The same occurs at node 3 and node 10. At node 13, the opposite happens, there is a higher investment considering the use, which is justified due to the fact that 100% of use is reached.

The average costs at the nodes are shown in Fig. 12. At the nodes with PV generation, the costs are lower when the use factor is considered, with an average cost of 44.02 €/MWh

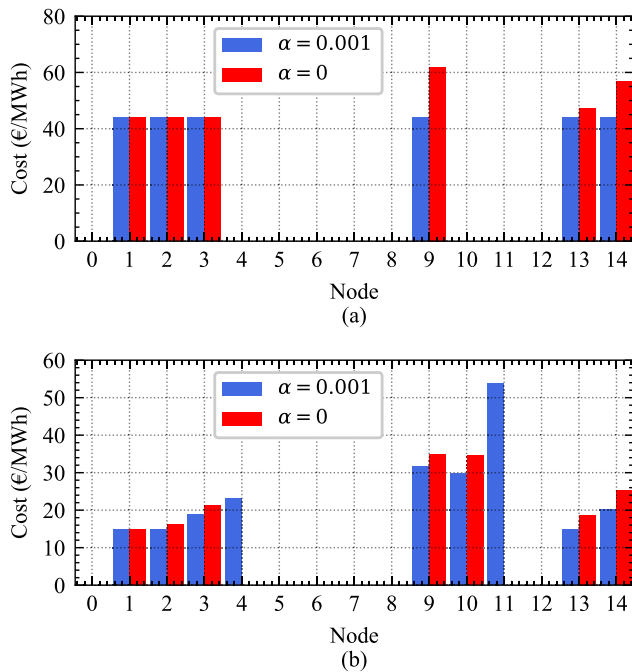

FIGURE 12. Installation cost per MWh injected for (a) PV generation, (b) wind generation.

TABLE 4. Results of two cases presented for scenario B.

	α	Investment (M€)	Total energy injected (MWh)	Cost (€/MWh)	Use (%)
PV	0.001	1.468	6.09	44.02	100
Wind	0.001	6.778	55.91	22.14	67.3
Total		8.246	62.00	24.29	75.2
PV	0	1.468	5.05	53.12	82.9
Wind	0	6.780	48.73	25.42	58.6
Total		8.248	53.78	28.02	64.5

compared to 53.12 €/MWh if α is set to 0. The average cost of wind generation follows the same trend, 22.14 €/MWh compared to 25.42 €/MWh without including the use. These figures represent a reduction of 17.14% for PV and 12.88% for wind generation.

It can be seen that at node 11 the cost of wind power generation with $\alpha > 0$ is higher than the others: 53.81 €/MWh. This is because a generic α is defined for all nodes and types of technology, and in this node the most important injections are of reactive power. The influence of this node is small and does not affect the overall result, because if the installation of generation in node 11 were not allowed, similar results would be obtained. A summary of the results obtained for scenario B is shown in Table 4.

It can be seen that as the use of both types of generation increases, more energy is injected. In particular, more than 1 MWh in the case of PV generation, and more than 7 MWh in the case of wind generation. These differences have an impact on the total average specific cost per MWh, which decreases by 13.31%, with wind generation being the most influential and advantageous to install.

Regarding network problems, current and voltage values are corrected. In Fig. 13, the currents through two overloaded

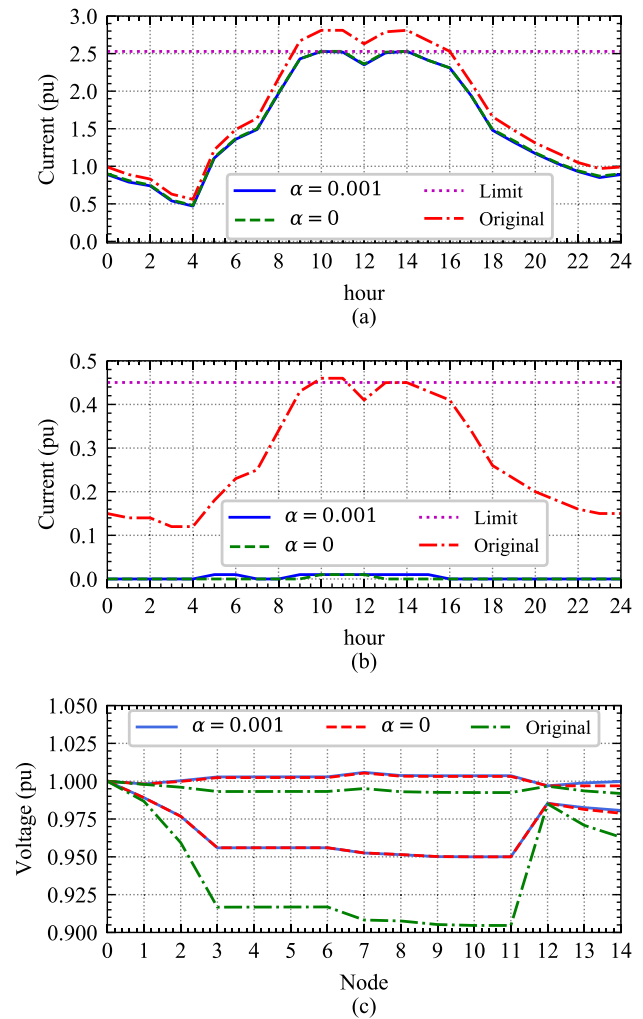

FIGURE 13. (a) Current evolution on branch 0-1, (b) on branch 2-3, and (c) maximum and minimum node voltage.

branches, 0-1 and 2-3, are shown. On branch 0-1, the profile is corrected when the maximum limits are exceeded. In branch 2-3, the current decreases to minimum values, since due to the minimization of the cost of losses in the objective function, it is more advantageous to feed directly into the nodes, minimizing the losses through the branches. As can be seen, the DSO perspective does not affect the owners. DSO only controls that there are no new problems or undesired situations, such as increased losses. Similarly, it can be seen how the minimum voltage values are corrected to admissible values above 0.95 pu.

The difference in the integration between the two cases is shown in Fig. 14, with the injection profiles PV and wind generation at node 14. In both cases the maximum power is injected in the key hours, but the rest of the time a better integration is observed with the proposed method.

Similarly to scenario A, Table 5 shows the results of varying α for scenario B. The influence of graduating the use is again observed. For this scenario, comparing the case of $\alpha = 2e-3$ with lower α values, a higher use (81.23%)

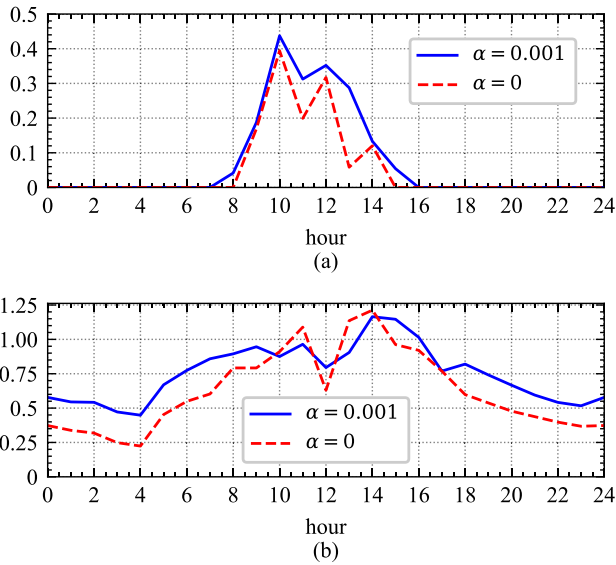

FIGURE 14. Evolution of power injection by DERs installed at node 14, (a) PV generation, (b) wind generation.

TABLE 5. Comparison of results for scenario B varying the parameter α .

α	Average use (%)	Energy losses reduction (%)	DER integration (%)	Average cost (€/MWh)
0	64.50	27.04	9.70	28.02
1e-4	68.62	27.04	9.88	27.50
5e-4	71.80	26.98	10.51	25.81
1e-3	75.20	26.83	11.18	24.29
2e-3	81.23	26.32	12.37	21.95
5e-3	91.67	24.42	14.43	18.80

and integration is obtained with similar loss reduction. This represents a cost reduction of 9.63% compared to an average use of 75.2% ($\alpha = 1e-3$). However, defining $\alpha = 5e-3$, although the highest average use is achieved (91.67%), the loss reduction is significantly lower compared to the values.

As shown in the results in Table 5, as in the scenario A, the influence and need to graduate the use and integration are observed, where more energy can be integrated at a lower cost, obtaining beneficial solutions.

In the presented results, an equal α has been defined for both types of generation to simplify the analysis, but it can be defined specifically for either type of generation. Fig. 15 shows how the use factor of PV generation varies when the coefficient α_{PV} is modified, maintaining fixed the coefficient of wind generation, α_W . As it can be seen, depending on the value of the coefficient α_W , its use remains at a constant value, while the use of PV varies depending on the value assigned to α_{PV} to graduate the use.

Therefore, it is possible to set for a particular technology (for example, fossil fuels) a lower percentage of use, increasing the integration of renewable energy instead.

C. SCENARIO C

This scenario is included with the intention of comparing the proposed methodology with another one based on LMP

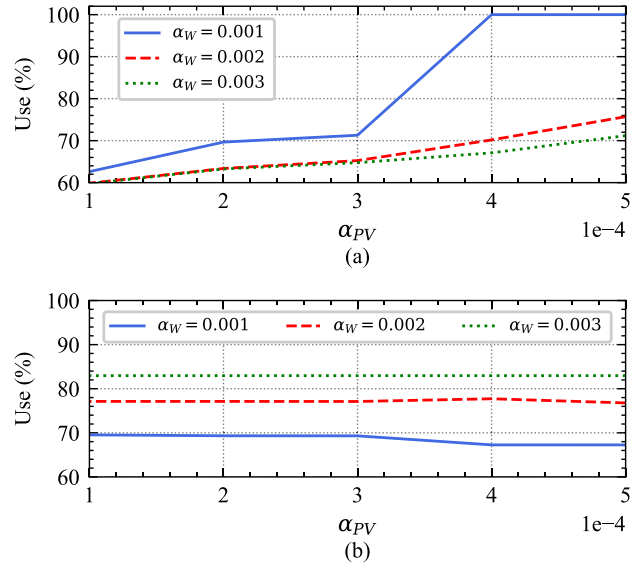

FIGURE 15. Influence of the parameter α in the use of the resources when different values are assigned to each type of DER, (a) PV generation (α_{PV}), (b) wind generation (α_W).

TABLE 6. Results obtained using an approach based on LMP.

Node	Power (MW)	Use (%)	Node	Power (MW)	Use (%)
1	0.998	6.42	8	0.119	9.93
2	0.359	7.03	9	0.119	6.42
3	0.119	5.98	10	0.119	6.43
4	0.125	9.59	11	0.119	6.43
5	0.119	9.70	12	4.929	20.70
6	0.119	6.43	13	4.222	19.07
7	0.119	9.19	14	2.939	18.30

as a signal to determine the power injections which solve problems in the network [23], [24]. In these approaches, the rated capacity of the DERs injecting that power is not specified, thus the maximum value of the injection at each node is considered as the installed capacity.

Table 6 describes the results obtained using the approach presented in [23], indicating the capacity needed at each node in MW and the percentage of use under the assumption that they are used only to solve problems in the network.

The low percentages of use are due to the fact that their use is analyzed only in the case they are needed to solve problems. To know the effect that the new DERs would have on the grid during the periods in which there are no problems, the following scenarios are assessed:

- The use is 100% of the rated value during the entire period, the problems in branches 0-1 and 0-12 are solved, but new problems appear in branches 10-11 and 12-13.
- The use is 80% of the rated value during the entire period, the problems in branches 0-1 and 0-12 are solved, and new problems do not appear.
- The use is 70% of the rated value during the entire period, the overload in branch 0-1 is solved, but problems continue in branch 0-12.

TABLE 7. Results obtained with the proposed methodology for $\alpha = 1e-3$.

Node	Power (MW)	Use (%)	Node	Power (MW)	Use (%)
1	0	–	8	0	–
2	0	–	9	0	–
3	0	–	10	0.333	99.14
4	0	–	11	0.198	96.58
5	0.316	99.77	12	6.975	96.16
6	0.327	93.78	13	0.045	98.49
7	0	–	14	0.559	96.95

Therefore, the results obtained by these types of methods must be assessed to consider the effect of new injections in the network during periods that were not previously problematic. With the LMP-based approach, 14.52 MW should be installed. Table 7 summarizes the results obtained for the same network with the proposed methodology. To compare similar situations, the parameter β is set to 0, which means that the minimization of energy losses is not considered. In this case, a total of 8.75 MW are installed at 7 nodes. The different results obtained with each approach are an effect of considering the cost of resources and their use. With the proposed methodology, the network problems are solved by installing less capacity and prioritizing a higher rate of use.

The proposed method adjusts the percentages of real use percentages due to the use factor and its weighting with the parameter α during the entire period. This is one of the advantages of the presented vision, to provide an effective integration of resources without the appearance of new problems. This avoids having to analyze the results and adjust the injections (use percentages) to solve new problems that may appear. This adjustment might be easy when dealing with generic generators, but it may be challenging when managing non-controllable resources with a specific generation profile.

V. CONCLUSION

In this paper, a DER location and integration methodology based on considering costs, technology, and degree of use during the lifetime of the installations is proposed. It combines the views of the owner and the DSO. Moreover, the methodology is valid for normal operation, but it is also interesting when DERs are assessed as non-wires solutions when problems like overload and voltage values outside the admissible margins appear.

The results demonstrate that it allows for an effective, secure, and realistic integration of DERs due to boosting the use, explicitly considering their utilization during the lifetime of the installations and not only considering problematic hours.

Taking into consideration the visions of the DER investor and DSO jointly for the optimal location, it is possible to obtain solutions profitable for the owners that do not cause harm to the grid (such as uncontrolled integration of DERs).

Considering the cost and type of technology is interesting, in addition to providing less costly and more cost-effective solutions, it allows the identification of the most appropriate

mix and size of resources in the network, with the possibility to stimulate the use of the most beneficial technologies.

Future work will focus on the inclusion of storage systems together with the use factor concept, to analyze which are the most convenient technologies to use in combination with energy storage systems, and the benefits they could produce for DER investors and DSOs.

REFERENCES

- [1] D. Hostick, D. Belzer, S. Hadley, T. Markel, and C. Marnay. (Jul. 2014). *Projecting Electricity Demand in 2050*. [Online]. Available: https://www.pnnl.gov/main/publications/external/technical_reports/PNNL-23491.pdf
- [2] McKinsey & Company. (2010). *Transformation of Europe's Power System Until 2050*. [Online]. Available: https://www.mckinsey.com/~/media/mckinsey/dotcom/client_service/epng/pdfs/transformation_of_europes_power_system.ashx
- [3] A. G. Anastasiadis, G. P. Kondylis, A. Polyzakis, and G. Vokas, "Effects of increased electric vehicles into a distribution network," *Energy Proc.*, vol. 157, pp. 586–593, Jan. 2019, doi: [10.1016/j.egypro.2018.11.223](https://doi.org/10.1016/j.egypro.2018.11.223).
- [4] B. Till, P. Cazzola, L. D'Amore, M. Gerner, S. Scheffer, R. Schuitmaker, H. Signollet, J. Tattini, and J. T. L. Paoli. (2019). *Global EV Outlook 2019 to Electric Mobility*. [Online]. Available: <https://www.iea.org/publications/reports/globalevoutlook2019/>
- [5] E. Parliament, "Directive (EU) 2018/2001 of the European parliament and of the council on the promotion of the use of energy from renewable sources," *Off. J. Eur. Union*, vol. 2018, no. 328, pp. 82–209, 2018. [Online]. Available: <https://eur-lex.europa.eu/legal-content/EN/TXT/PDF/?uri=CELEX:32018L2001&from=EN>
- [6] V. Vahidinasab, M. Tabarzadi, H. Arasteh, M. Alizadeh, M. M. Beigi, H. R. Sheikhzadeh, K. Mehran, and M. Sepasian, "Overview of electric energy distribution networks expansion planning," *IEEE Access*, vol. 8, pp. 34750–34769, 2020, doi: [10.1109/ACCESS.2020.2973455](https://doi.org/10.1109/ACCESS.2020.2973455).
- [7] L. Gacitua, P. Gallegos, R. Henriquez-Auba, A. Lorca, M. Negrete-Pincetic, D. Olivares, A. Valenzuela, and G. Wenzel, "A comprehensive review on expansion planning: Models and tools for energy policy analysis," *Renew. Sustain. Energy Rev.*, vol. 98, pp. 346–360, Dec. 2018, doi: [10.1016/j.rser.2018.08.043](https://doi.org/10.1016/j.rser.2018.08.043).
- [8] G. Munoz-Delgado, J. Contreras, and J. M. Arroyo, "Joint expansion planning of distributed generation and distribution networks," *IEEE Trans. Power Syst.*, vol. 30, no. 5, pp. 2579–2590, Sep. 2015, doi: [10.1109/TPWRS.2014.2364960](https://doi.org/10.1109/TPWRS.2014.2364960).
- [9] G. Munoz-Delgado, J. Contreras, and J. M. Arroyo, "Distribution network expansion planning with an explicit formulation for reliability assessment," *IEEE Trans. Power Syst.*, vol. 33, no. 3, pp. 2583–2596, May 2018, doi: [10.1109/TPWRS.2017.2764331](https://doi.org/10.1109/TPWRS.2017.2764331).
- [10] J. E. Contreras-Ocana, Y. Chen, U. Siddiqi, and B. Zhang, "Non-wire alternatives: An additional value stream for distributed energy resources," *IEEE Trans. Sustain. Energy*, vol. 11, no. 3, pp. 1287–1299, Jul. 2020, doi: [10.1109/TSTE.2019.2922882](https://doi.org/10.1109/TSTE.2019.2922882).
- [11] T. Stanton, "Getting the signals straight: Modeling, planning, and implementing non-transmission alternatives," Nat. Regulatory Res. Inst., Silver Spring, MD, USA, Tech. Rep. 15-02, 2015.
- [12] D. Z. Fitiwi and V. Bertsch, "Interactions between demand response and network expansion planning: A quantitative analysis," in *Proc. 15th Int. Conf. Eur. Energy Market (EEM)*, Jun. 2018, pp. 1–6, doi: [10.1109/EEM.2018.8469792](https://doi.org/10.1109/EEM.2018.8469792).
- [13] J. Domínguez, J. P. Chaves-Ávila, T. G. S. Román, and C. Mateo, "The economic impact of demand response on distribution network planning," in *Proc. 19th Power Syst. Comput. Conf.*, Jun. 2016, pp. 1–7, doi: [10.1109/PSCC.2016.7540892](https://doi.org/10.1109/PSCC.2016.7540892).
- [14] P. Gupta, M. Pandit, and D. P. Kothari, "A review on optimal sizing and siting of distributed generation system: Integrating distributed generation into the grid," in *Proc. 6th IEEE Power India Int. Conf. (PIICON)*, Dec. 2014, pp. 1–6, doi: [10.1109/34084POWERI.2014.7117648](https://doi.org/10.1109/34084POWERI.2014.7117648).
- [15] M. Benidris, Y. Tian, S. Sulaeman, and J. Mitra, "Optimal location and size of distributed energy resources using sensitivity analysis-based approaches," in *Proc. 48th North Amer. Power Symp.*, Sep. 2016, pp. 1–5, doi: [10.1109/NAPS.2016.7747855](https://doi.org/10.1109/NAPS.2016.7747855).

- [16] R. S. F. Ferraz, R. S. F. Ferraz, A. C. Rueda-Medina, and O. E. Batista, "Genetic optimisation-based distributed energy resource allocation and recloser-fuse coordination," *IET Gener., Transmiss. Distrib.*, vol. 14, no. 20, pp. 4501–4508, Oct. 2020, doi: [10.1049/iet-gtd.2020.0664](https://doi.org/10.1049/iet-gtd.2020.0664).
- [17] E. S. Oda and A. A. Abdelsalam, "Optimal DGs allocation in distribution networks using modified flower pollination algorithm," in *Proc. 19th Int. Middle East Power Syst. Conf. (MEPCON)*, Dec. 2017, pp. 1424–1429, doi: [10.1109/MEPCON.2017.8301370](https://doi.org/10.1109/MEPCON.2017.8301370).
- [18] K. Mahmoud, N. Yorino, and A. Ahmed, "Optimal distributed generation allocation in distribution systems for loss minimization," *IEEE Trans. Power Syst.*, vol. 31, no. 2, pp. 960–969, Mar. 2016, doi: [10.1109/TPWRS.2015.2418333](https://doi.org/10.1109/TPWRS.2015.2418333).
- [19] Y. Gupta, S. Doolla, K. Chatterjee, and B. C. Pal, "Optimal DG allocation and Volt-Var dispatch for a droop-based microgrid," *IEEE Trans. Smart Grid*, vol. 12, no. 1, pp. 169–181, Jan. 2021, doi: [10.1109/TSG.2020.3017952](https://doi.org/10.1109/TSG.2020.3017952).
- [20] B. Zhang, P. Dehghanian, and M. Kezunovic, "Optimal allocation of PV generation and battery storage for enhanced resilience," *IEEE Trans. Smart Grid*, vol. 10, no. 1, pp. 535–545, Jan. 2019, doi: [10.1109/TSG.2017.2747136](https://doi.org/10.1109/TSG.2017.2747136).
- [21] S. Bose and E. Bitar, "Variability and the locational marginal value of energy storage," in *Proc. 53rd IEEE Conf. Decis. Control*, Dec. 2014, pp. 3259–3265, doi: [10.1109/CDC.2014.7039893](https://doi.org/10.1109/CDC.2014.7039893).
- [22] A. Papavasiliou, "Analysis of distribution locational marginal prices," *IEEE Trans. Smart Grid*, vol. 9, no. 5, pp. 4872–4882, Sep. 2017, doi: [10.1109/TSG.2017.2673860](https://doi.org/10.1109/TSG.2017.2673860).
- [23] P. Andrianesis, M. Caramanis, R. D. Masiello, R. D. Tabors, and S. Bahramirad, "Locational marginal value of distributed energy resources as non-wires alternatives," *IEEE Trans. Smart Grid*, vol. 11, no. 1, pp. 270–280, Jan. 2020, doi: [10.1109/TSG.2019.2921205](https://doi.org/10.1109/TSG.2019.2921205).
- [24] H. Nasiri, S. Bahramirad, M. Shahidehpour, A. E. Paaso, N. M. Abdullah, Maigha, and D. Kushner, "Networked-constrained DER valuation in distribution networks," *IEEE Trans. Smart Grid*, vol. 11, no. 6, pp. 4809–4817, Nov. 2020, doi: [10.1109/TSG.2020.3002425](https://doi.org/10.1109/TSG.2020.3002425).
- [25] P. Andrianesis and M. Caramanis, "Distribution network marginal costs—Part I: A novel AC OPF including transformer degradation," 2019, *arXiv:1906.01570*.
- [26] *Benchmark Systems for Network Integration of Renewable and Distributed Energy Resources*, CIGRE, Paris, France, Apr. 2014.
- [27] International Renewable Energy Agency. (2020). *Renewable Power Generation Costs in 2019*. [Online]. Available: https://www.irena.org/-/media/Files/IRENA/Agency/Publication/2020/Jun/IRENA_Power_Generation_Costs_2019.pdf

CARLOS GARCÍA-SANTACRUZ was born in Córdoba, Spain. He received the Industrial Engineering degree and the M.Sc. degree in electrical energy systems from the University of Seville, where he is currently pursuing the Ph.D. degree in electrical engineering. His research interests include integration and management of distributed energy resources, smart grid operation, and optimization in power systems.

ALEJANDRO MARANO-MARCOLINI received the Electrical Engineering degree from the University of Malaga, and the Ph.D. degree from the University of Seville, Spain, in 2010. He is currently an Associate Professor with the University of Seville. His primary research interests include voltage stability, integration of distributed generation, and optimization applied to power system engineering.

JOSÉ LUIS MARTÍNEZ-RAMOS (Senior Member, IEEE) was born in Dos Hermanas, Spain, in 1964. He received the Ph.D. degree in electrical engineering from the University of Seville, Seville, Spain, in 1994. Since 1990, he has been with the Department of Electrical Engineering, University of Seville, where he is currently a Full Professor. His primary research interests include active and reactive power optimization, power system planning, analysis and control, and electricity markets.

• • •