

PUENTES DE HIERRO

ECONOMICOS

MUELLES Y FAROS

SOBRE

PALIZADAS Y PILOTES METÁLICOS

POR

DON JOSÉ EUGENIO RIBERA

Ingeniero de Caminos, Canales y Puertos.

ATLAS

MADRID

LIBRERÍA EDITORIAL

DILLY-BAILLIERE É HIJOS

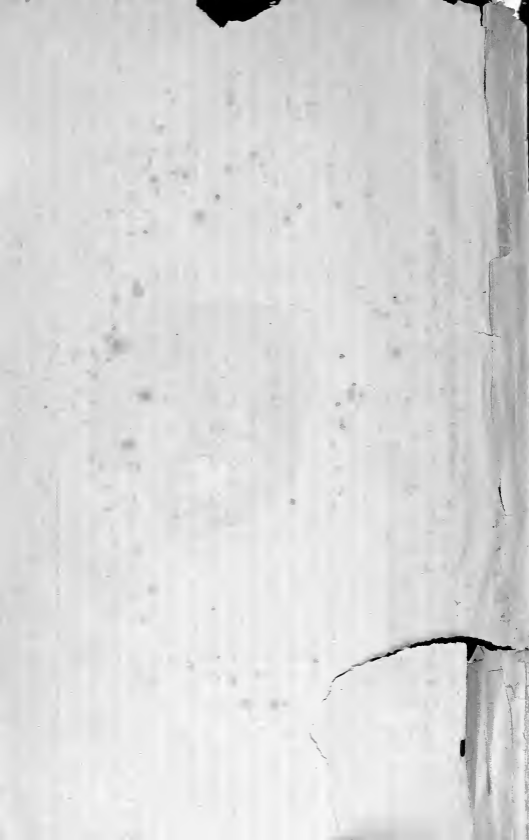
Calle de Santa Ana, núm. 10.

Pla

(Derechos reservados).

BIBLIOTECA INDUSTRIAL

855 7
4
N.º 1400





600056522

ESCUELA TÉCNICA DE PERITOS INDUSTRIALES
DE SEVILLA

ESTANTE

2

T A B L A

7

NÚMERO

537

LIBRERIA EDITORIAL DE BAILLY-BAILLIERE E HIJOS
— Plaza de Santa Ana, núm. 10, MADRID. —

EN PREENSA PARA PUBLICARSE EN 1895

TABLAS
TAQUIMÉTRICAS
SEXAGESIMALES Y CENTESIMALES

DE BOLSILLO

PARA USO DE LOS INGENIEROS EN EL CAMPO

POR F. GASCUE

Ingeniero de Minas.

Un tomito en 16.º, de unas 100 páginas.

PROPIEDADES FUNDAMENTALES

DE LAS

CORRIENTES ALTERNAS SIMPLES
Y POLIFÁSICAS

ACOPLAMIENTO DE LOS ALTERNADORES

ESTUDIO ELEMENTAL ANALÍTICO Y GRÁFICO

POR

DON LUIS DE LA PEÑA Y BRAÑA.

Ingeniero de Minas.

Un tomo en 12.º, de unas 300 páginas y unas 80 figuras
intercaladas en el texto.

R-537.-

PUENTES DE HIERRO

ECONOMICOS

MUELLES Y FAROS



SOBRE

PALIZADAS Y PILOTES METÁLICOS

POR

DON JOSÉ EUGENIO RIBERA

Ingeniero de Caminos, Canales y Puertos.

ATLAS

A
624.014
RIB II

MADRID

LIBRERÍA EDITORIAL
DE BAILLY-BAILLIERE É HIJOS
Plaza de Santa Ana, núm. 10.

1895

U18519891

PRINCIPALES CORRESPONSALES

DE LA LIBRERÍA EDITORIAL DE BAILLY-BAILLIÈRE É HIJOS

Fin de la lista de Corresponsales.

SEVILLA.—E. Torres.—Fe (Juan Antonio).—Tomás Sanz.—Carmena.—José Domínguez.—Constantina.—José González.—Echa.—E. Ottone.—Marchena.—Felipe G. Foment.—Morón de la Frontera.—Francisco Gil Montes.—Osuna.—Antonio Delgado.

SORIA.—Pedro Nolasco Sebastián.

TARRAGONA.—J. Fontó hijos.—S. Ginesta Salla.—Reus.—Sardá, Nutró y C.²—Viuda de Torroja.—Tortosa.—Francisco Mestre.—Hermanas herederos de Luis Bernis.—Valls.—F. Bius.

TEGUCIGALPA.—Pedro Pantr Navarro.

TOLDO.—Menor hermanos.—Viuda é hijos de Peláez.—Talavera de la Reina.—A. López.

VALENCIA.—Paseual Aguilar.—Ramón Ortega.—Alicia.—José Muñoz Ferriz.—Cargente.—Vicente Crespo.—Gandía.—Ignacio Espi.—Jatifa.—Ramón Talens.—Onteniente.—Francisco Vila.—Requena.—J. Viana.—Martín Gil.—Suca.—R. Benedito.—Federico Cebolla.

VALLADOLID.—Hijos de Rodríguez.—Jorge Muetero.—Testamentaria de Juan Nuevo.—Leonardo Miñón.

VIZCAYA.—Bilbao.—Balfy y comp.²—Dochoa.—Eleuterio Villar.—Ondarou.—Bermeo.—Asociación Alamos.—Guernica y Leud.—Antonio Egurrola.

ZAMORA.—Viuda de M. Rico.—Pablo Soudin.

ZARAGOZA.—Cecilio Gasca.—Crespo y Alconchel.—Julian Sanz.—Agustín Alasé.—Catalayud.—G. Guillén.—Caspé.—Jerónimo Dolader.

Isla de Cuba.

HABANA.—Viuda é hijos de Chao.—J. Merino.—Santiago López.—Viuda de Pozo.—Guzmán.—N...
MATANZAS.—Germesindo Moreno.—Cárdenas.—José Albitos.
PINAS DEL RIO.—Marcos Mijares.—Agustín Jofré.
SANTA CLARA.—Eduardo Pegudo.—Cienfuegos.—J. Torres y comp.²—Esperanza.—Tomás Rodríguez.—Sagua la Grande.—Ciriano Navarro.—Sancti-Spiritus.—Eduardo Alvarez.—San Juan de los Remedios.—M. R. García.
SANTIAGO DE CUBA.—Juan Pérez Dubrull.—Gibara.—Martín Bim Canta.—Guantánamo.—Nicolás Gallinat.—Manzanillo.—Donatilo Jaime Puig.

Puerto Rico.

PUERTO RICO.—B. F. Sanjurjo Vidal.—J. González Font.—José J. Acosta (Sucesión de).—Guayama.—Castillo y Luzmaris.—Mayagüez.—José Leandro Montalvo.
PONCE.—Olimpio Otero.

Filipinas.

MANILA.—Enrique Bota.
LAGAIG.—José D. de la Campa.
ILO-ILO.—Pineda hermanos.

América central.

GUATEMALA.—Alfonso Vidal.—Antonio Partegás.
COSTA RICA.—San José.—Vicente Lines.—A. Font.
REPÚBLICA DOMINICANA.—Santo Domingo.—F. Henríquez y Carvajal.—Santiago de los Caballeros.—U. Franco Bidó.

NICARAGUA.—León.—F. Mayorga.—J. M. Zepeda.
SAN SALVADOR.—J. G. Espinosa.—Mariano Duarte.

América septentrional.

MÉXICO.—Herrero y comp.²—J. Ballezá y comp.²—Juan de la Fuente y Garcés.—Carmen.—N...—Chilpancingo.—Cayetano Soberón.—Cuernavaca.—Bernabé L. de Elias.—Catiacan.—M. R. Pareces.—Durango.—I. de la Torre.—Guadalupe.—N. Puga.—Guajuato.—Pedro de la Fuente.—Hermosillo.—M. F. de Castro.—Jalapa.—P. M. Lucmo.—Mazatlán.—A. M. Verdies.—Emilia Saluz de Durán.—Monterrey.—Theo Muris.—Nueva Laredo.—Santiago Cárdenas.—Orizaba.—Juan Zenón González.—Oaxaca.—Luís Fernández.—Parras de la Fuente.—E. Maynez.—Puebla.—F. Sentios y comp.²—C. Baur.—San Juan Bautista.—J. M. Graham.—San Luis de Potosí.—A. Cabrera.—Saltillo.—A. Farga.—Veracruz.—R. Rodríguez Jiménez.
SAN FRANCISCO DE CALIFORNIA.—J. Taury y comp.²

América meridional.

ARGENTINA (REPÚBLICA).—Buenos Aires.—A. Etchepareborda.—Gustavo Mendezky.—La Argentina.—Córdoba.—L. Simián.—La Plata.—Solá hermanos.—Mendoza.—Flavio Porcz.—Rosario.—J. Penser.
BOLIVIA.—La Paz.—Forquea.—J. M. Farfán.—Cochabamba.—Aurelio Pacieri.—Potosí.—S. Vera.
CHILE.—Concepción.—José M. Serrato.—Santiago.—Roberto Miranda.—Talca.—Juan C. Azócar.—Valparaíso.—Carlos F. Niemeyer.
COLOMBIA.—Bogotá.—Camacho Roldán y Tamayo.—Barranquilla.—Pedro Celestino Angulo.—Bucaramanga.—D. Martínez.—Cali.—Juan A. Sanchez.—Cartagena.—J. F. Vélez.—Medellín.—Clodomiro Díaz G.—Panamá.—I. Preciado y C.²—Sincelejo.—Ignacio Salou y C.²
ECUADOR.—Guayaquil.—Pedro Jauer.—Quito.—N. Montesdeoca.—Machala.—J. Camilo Mora.
PERÚ.—Lima.—Colville y comp.²—Viuda de Gallaud.—Arequipa.—Ramón Albareda.—M. Darío Arras.—Trujillo.—M. Gustavo Espinosa.
URUGUAY.—Montevideo.—A. Rins.—Paisandu.—Mariano Comas.—Salto.—Aurelio Cucuca.
VENEZUELA.—Barcelona.—Salazar.—Caracas.—F. N. Correa Perez.—Planchart y Velutini.—L. Puig Ros y hermano.—Carúpano.—Carrera Mayz.—Ciudad Bolívar.—A. J. Montes.—M. Rodríguez.—Maracaibo.—M. N. Rincón y comp.²—San Cristóbal.—Flores hermanos.—Valera de Trujillo.—Pompeyo A. Oлива.—Valencia.—Mendez hermanos.

Antillas holandesas.

CURAÇAO.—Willemstad.—A. Bethencourt é hijos.

Extranjero.

PARÍS.—J. B. Baillière et Fils.—Roger et Chernoviz.
LONDRES.—Baillière Tindall and Co.

PUENTES DE HIERRO

ECONÓMICOS

MUELLES Y FAROS

SOBRE

PALIZADAS Y PILOTES METÁLICOS

ATLAS

OBRAS DEL MISMO AUTOR

El tranvía de vapor de Torrelavega á Infiesto y Covadonga. — Estudio sobre los tranvías de vapor.

EN PREPARACIÓN

Cálculos y proyectos de los tramos metálicos.
Puentes metálicos, en arco, para grandes luces.

Fig. 1. PUENTE DE SAIGÓN (COCHINCHINA)

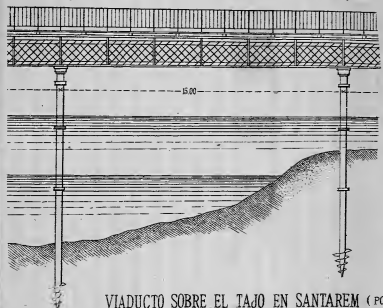
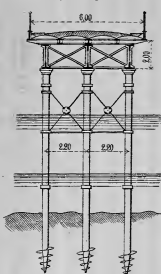


Fig. 2.



VIADUCTO SOBRE EL TAJO EN SANTAREM (PORTUGAL)

Fig. 3.

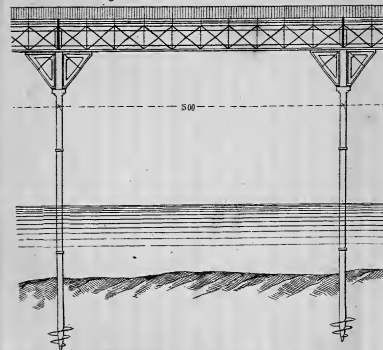


Fig. 4.

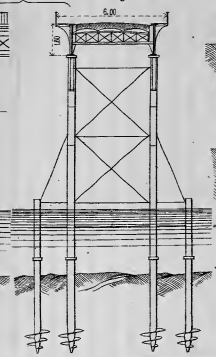
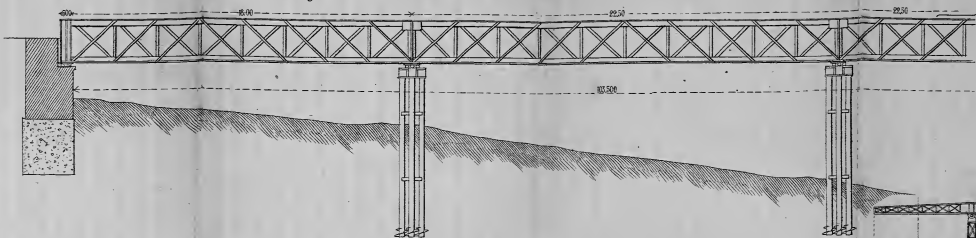


Fig. 5. PUENTE SOBRE EL RIO MARATECA. (PORTUGAL)



PUENTE SOBRE EL CANAL AZAMBUJA (PORTUGAL)

Fig. 7.

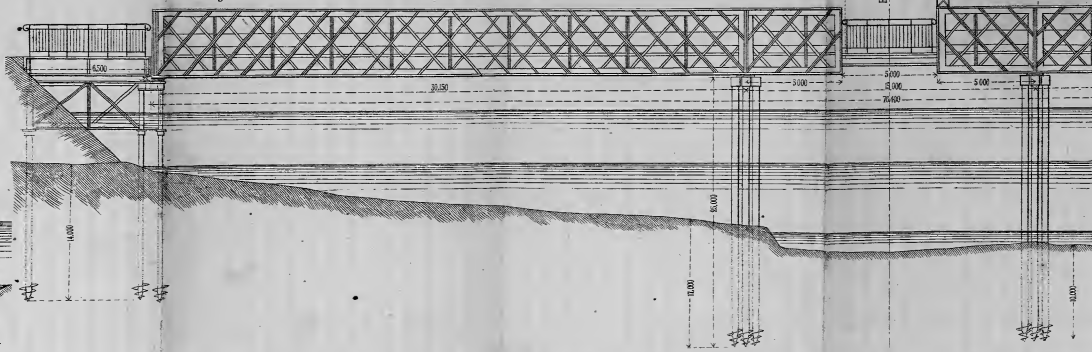


Fig. 6. SEMI SECCION LR. 2.25

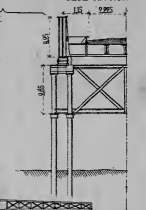


Fig. 2. SECCION DEL 1º PUENTE

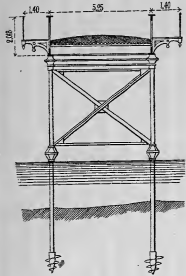
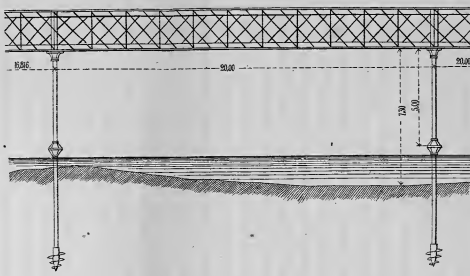


Fig. 1. PUENTE ALEARDI SOBRE EL ADIGE EN VERONA



SECCION DEL PUENTE NUEVO

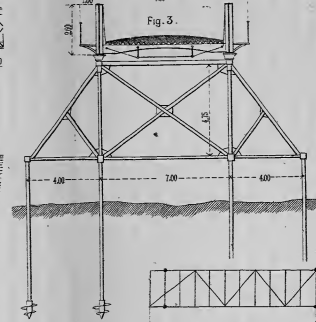
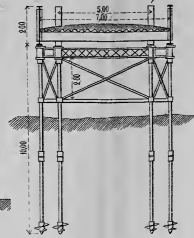
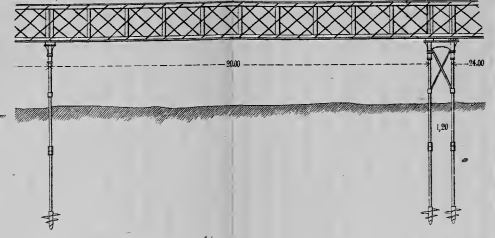


Fig. 4.



PUENTE SOBRE EL ADIGE EN ZEVIO

Fig. 5.



PLANTA ESCALA DE 1/500

Fig. 6.

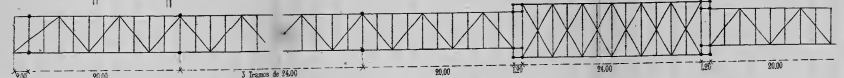
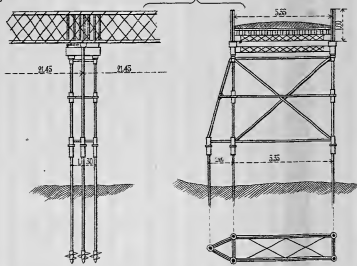


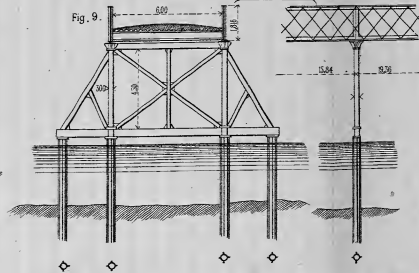
Fig. 7. PUENTE SOBRE EL BRENTA EN CURTAROLO

Fig. 8.



PUENTE SOBRE EL BACHIGLIONE EN TENCAROLA

Fig. 10.



PUENTE SOBRE EL BRENTA EN VIGNOVO

Fig. 12.

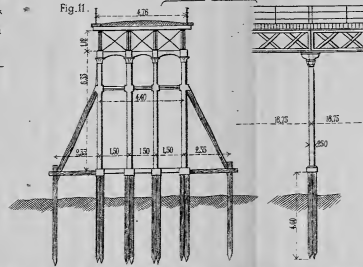
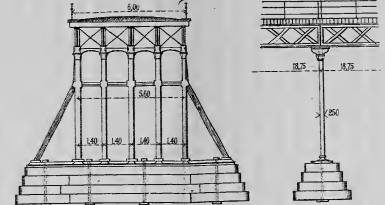
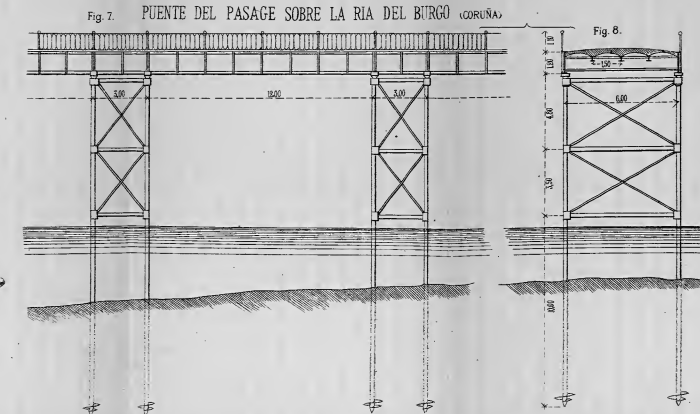
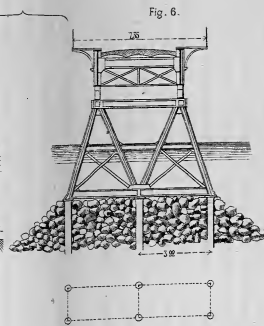
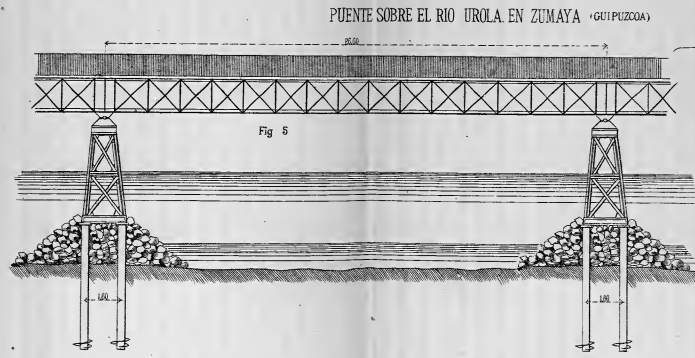
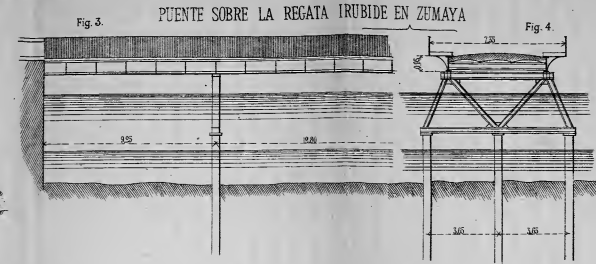
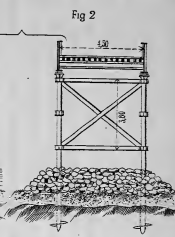
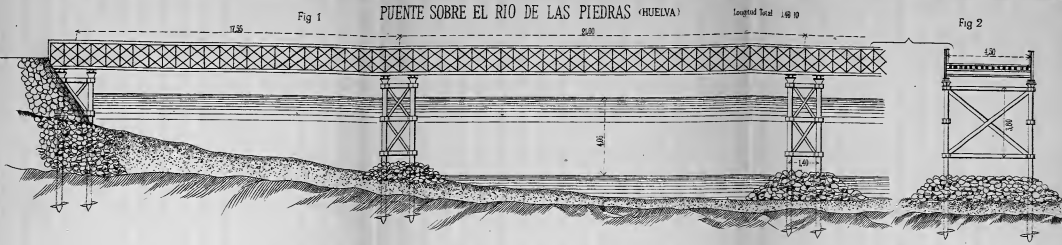


Fig. 13. PUENTE SOBRE EL BRENTA EN STRÁ

Fig. 14.





VIADUCTO DE LEVEN (INGLATERRA)

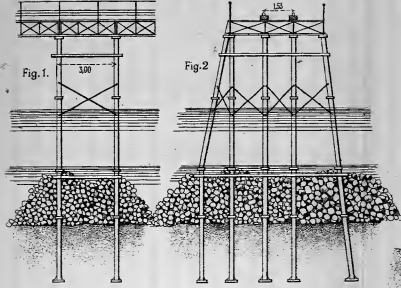
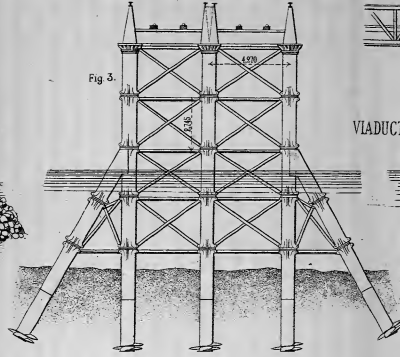
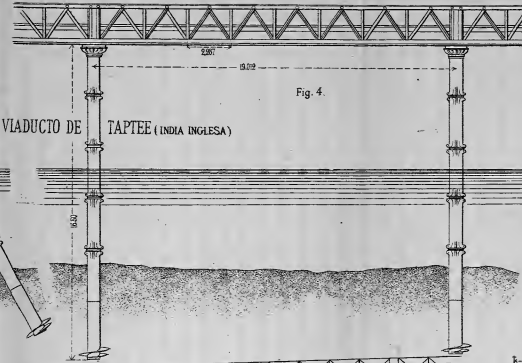


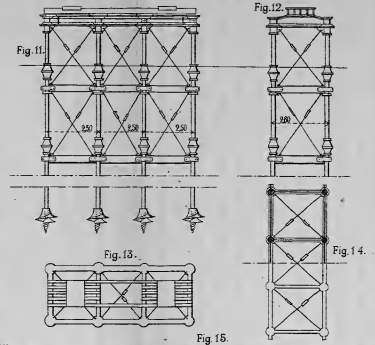
Fig. 3.



VIADUCTO DE TAPTEE (INDIA INGLESA)



PUENTE DE MOBILE (ESTADOS UNIDOS)



PUENTE DE LA VIÑA DEL MAR (CHILE)

Fig. 5. PARA EL FERRO CARRIL DE VALPARAISO A SANTIAGO

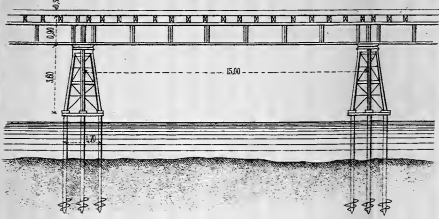


Fig. 6.

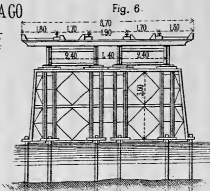
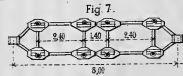


Fig. 7.



VIADUCTO DE LA GUAIRA (VENEZUELA)

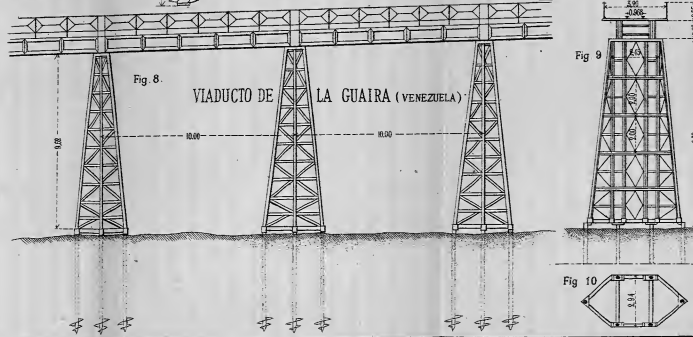
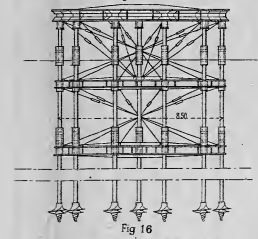
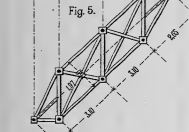
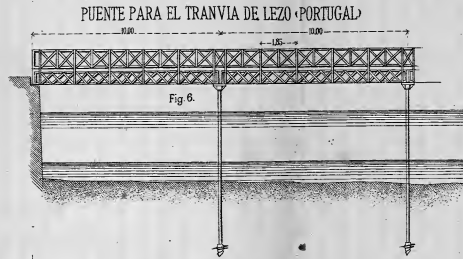
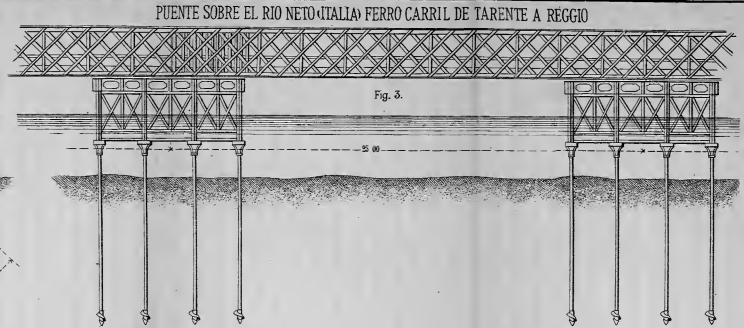
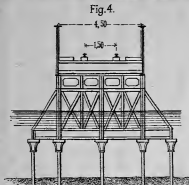
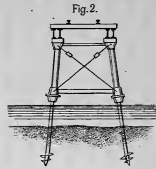
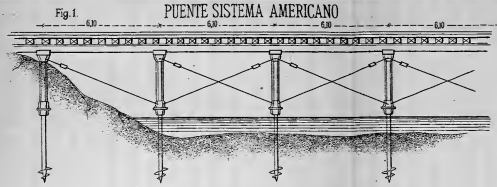


Fig. 10.



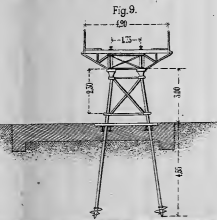
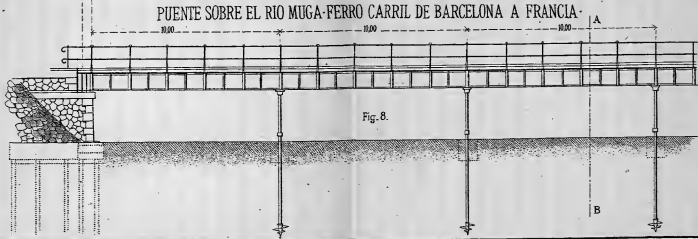
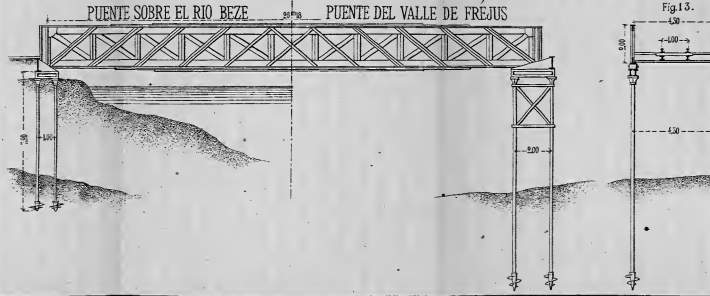
Fig. 16.





FERRO CARRIL DEL SUR DE FRANCIA

Fig. 11. Fig. 12.



PUENTE SISTEMA OPPERMANN

Fig. 1.

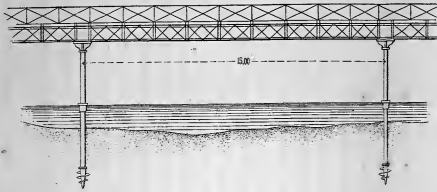


Fig. 2.

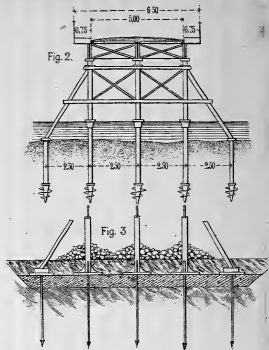
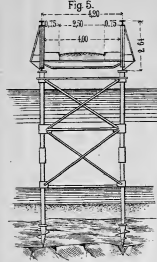
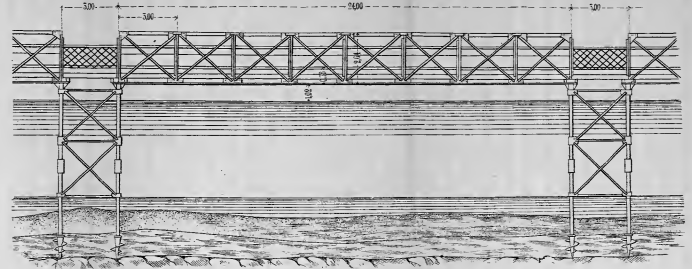


Fig. 5.



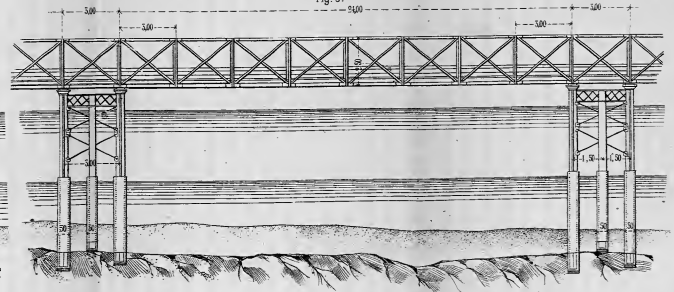
PUENTE SISTEMA EIFFEL

Fig. 4.



PUENTE SISTEMA THOMAS ET FOUCART

Fig. 6.



PUENTES SISTEMA POZZI

Fig. 8.

Fig. 9.

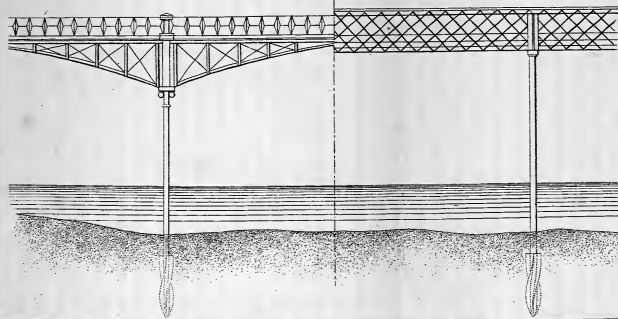


Fig. 10.

Fig. 11.

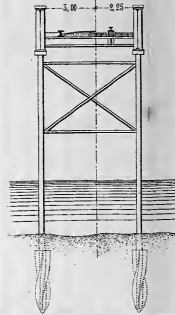
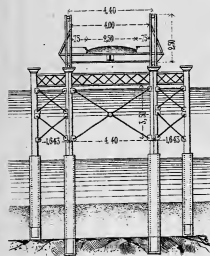
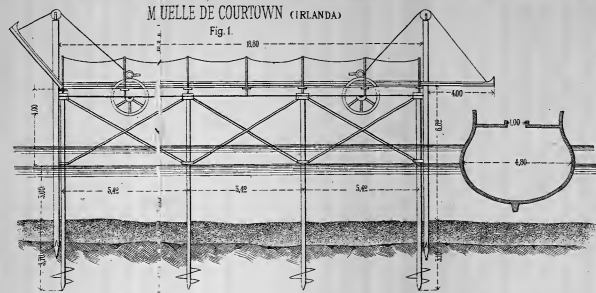


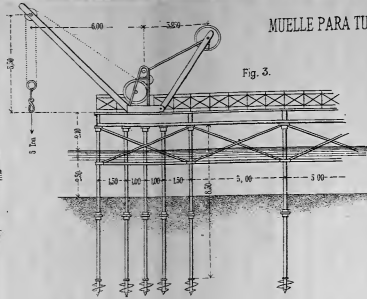
Fig. 7.





MUELLE DE COURTOWN (IRLANDA)

Fig. 1.



MUELLE PARA TURQUIA ASIATICA

Fig. 3.

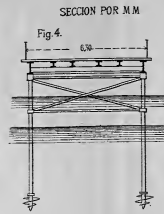


Fig. 4.

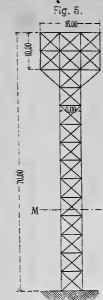


Fig. 5.

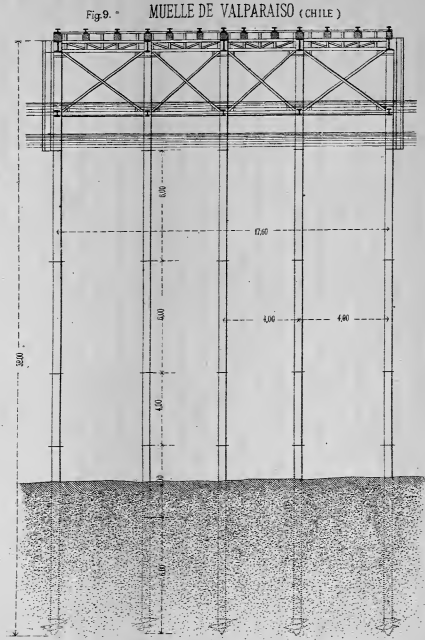
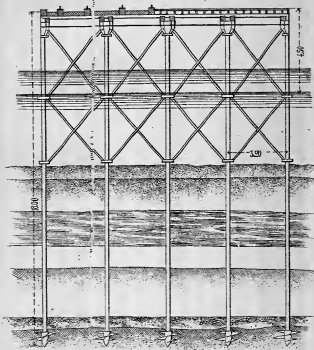


Fig. 9. MUELLE DE VALPARAISO (CHILE)

Fig. 2. MUELLE DEL DELAWARE (ESTADOS UNIDOS)



EMBARCADERO PARA EL CONGO (AFRICA)

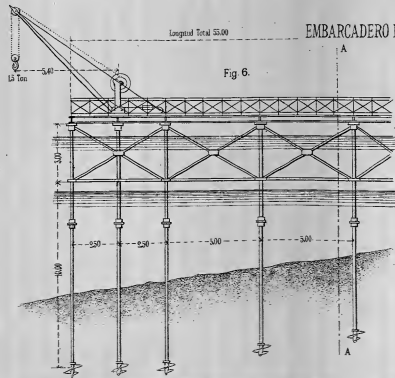


Fig. 6.

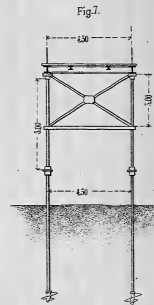
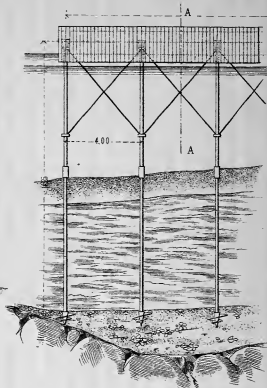
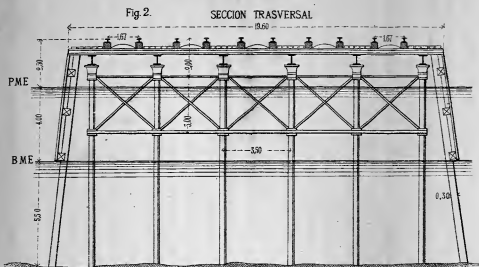


Fig. 7.

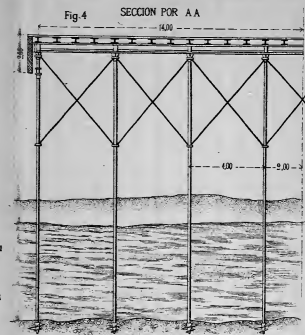
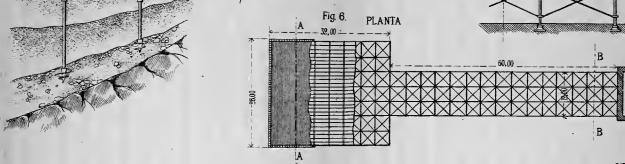


Fig. 8.

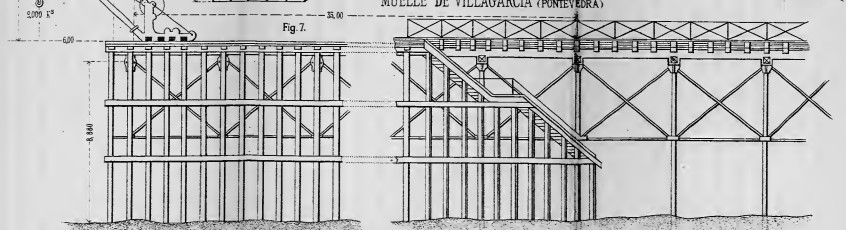
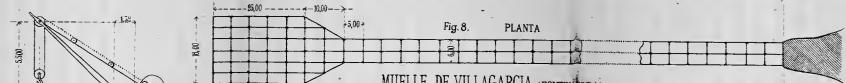
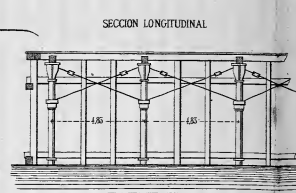
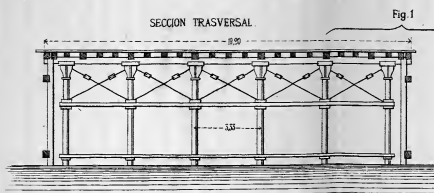
MUELLE DE PUNTALES (CADIZ)



MUELLE DE MAYAGÜEZ (PUERTO RICO)



MUELLE DE LA CORUÑA



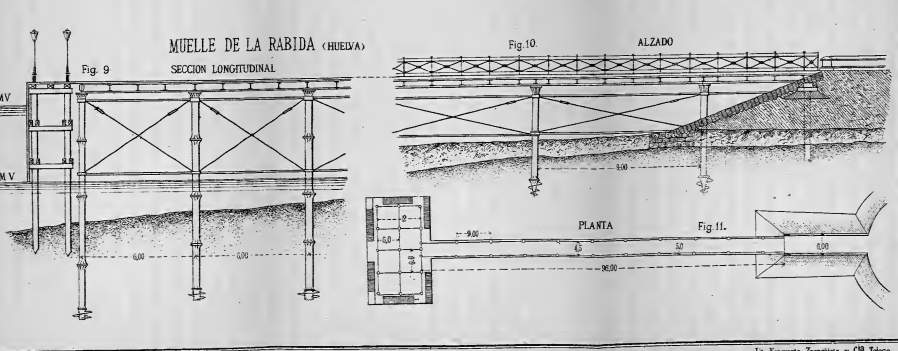
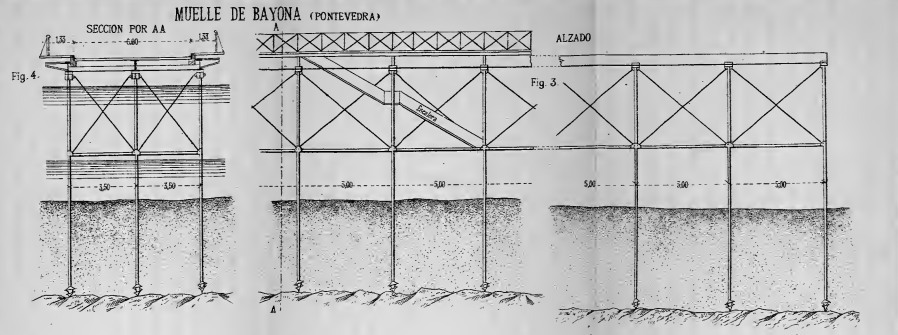
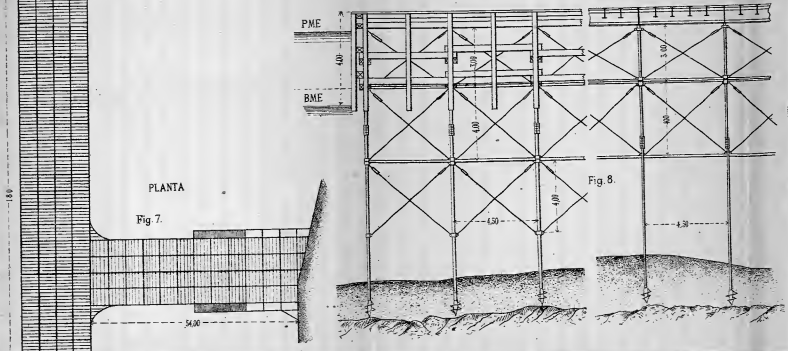
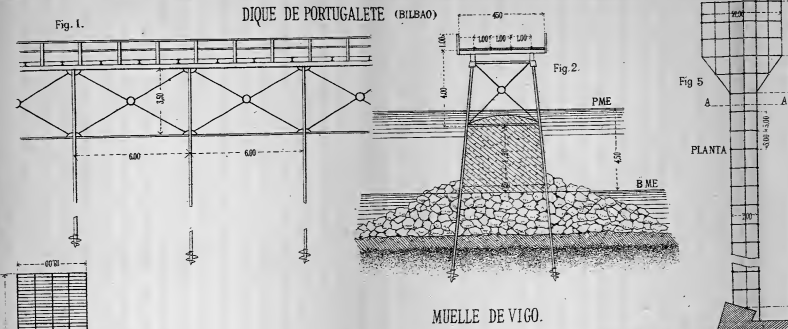
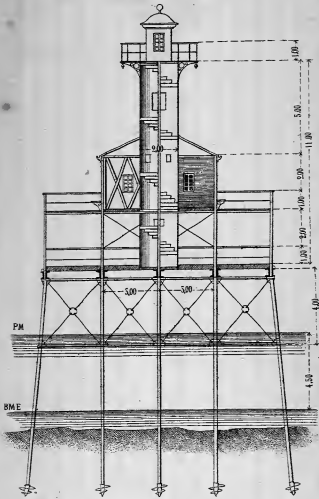


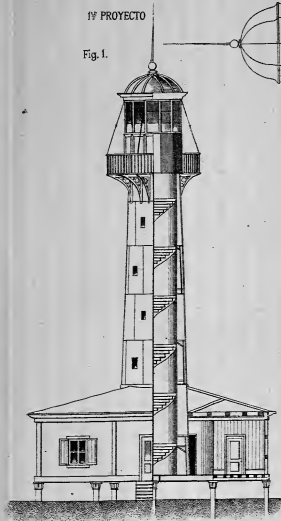
Fig. 6.
TORRE DE SENALES DE PORTUGALETE



FARO DE LA BAÑA

1ª PROYECTO

Fig. 1.



FARO DE BUDA

Fig. 2.

FARO DE LA BAÑA
2ª PROYECTO ADOPTADO



Fig. 3.

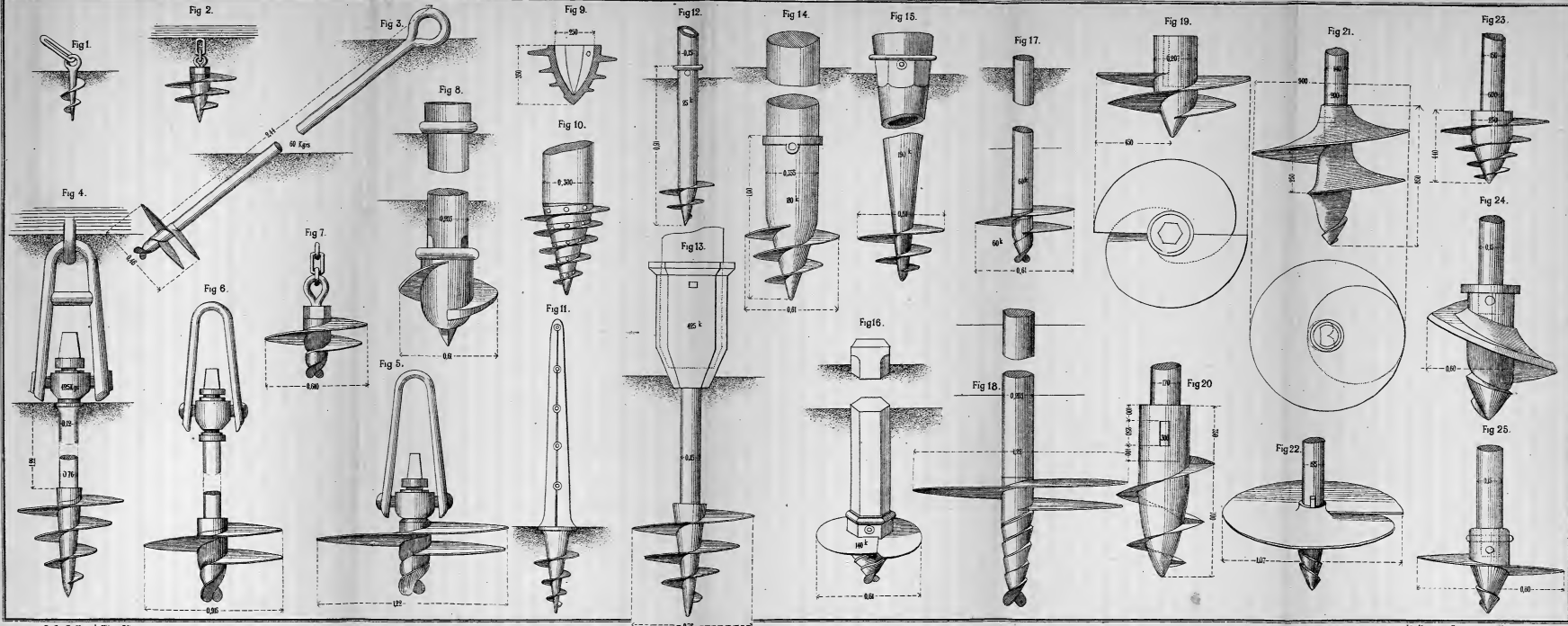
FARO DEL FANGAR
1ª PROYECTO

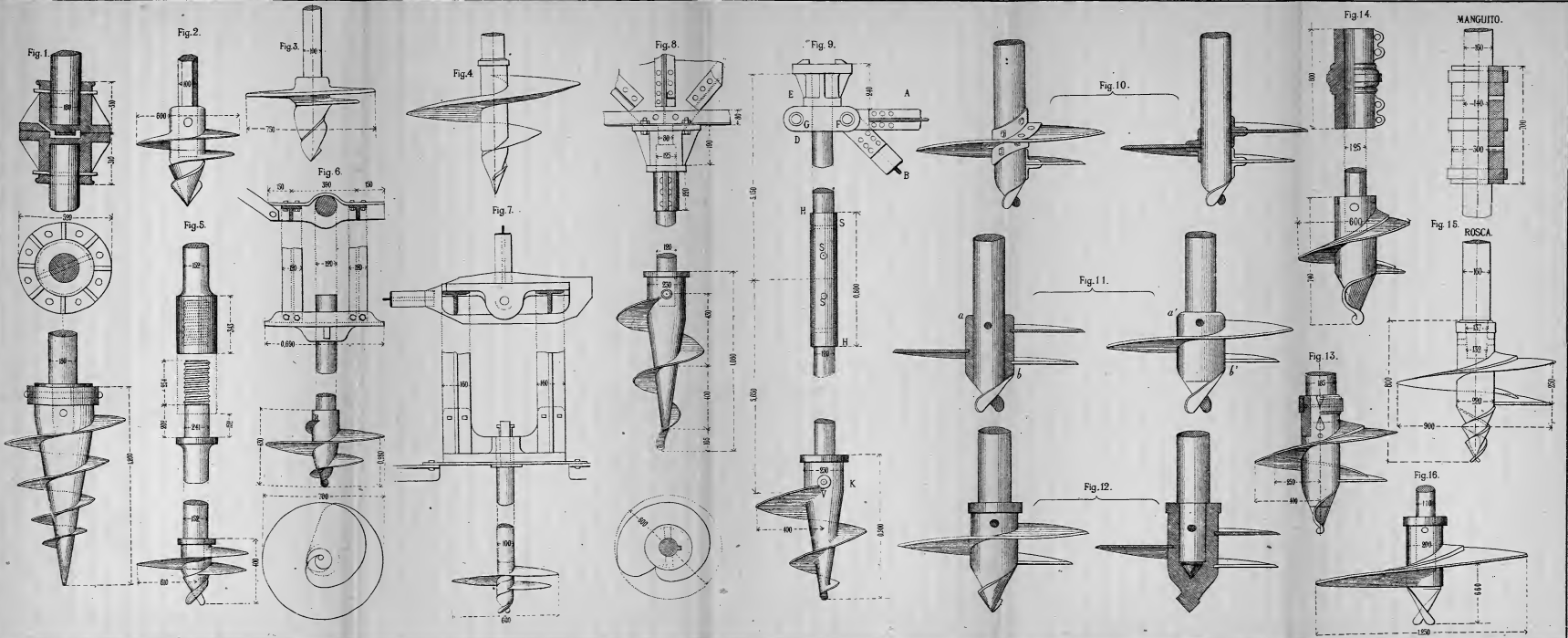


Fig. 4.

2ª PROYECTO ADOPTADO







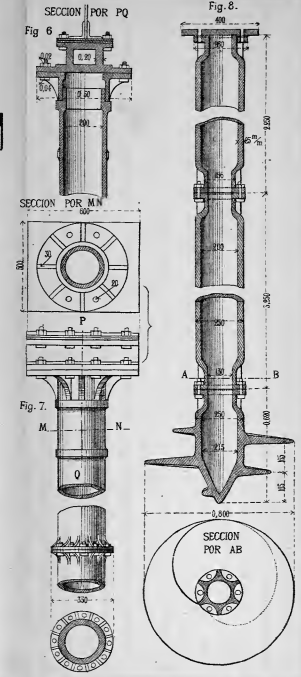
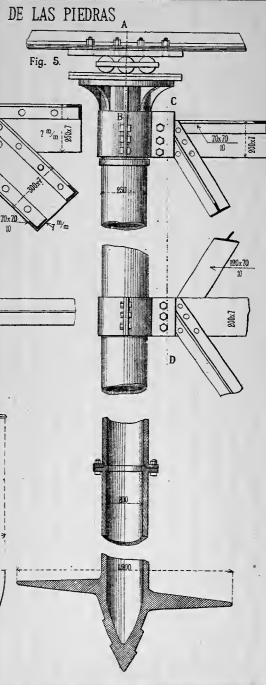
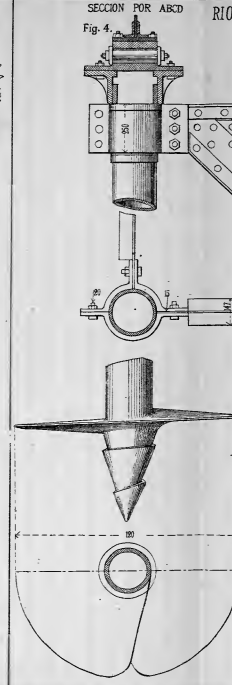
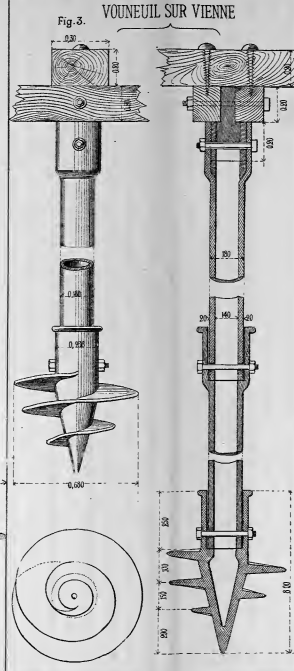
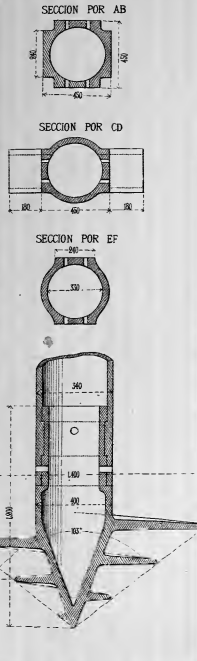
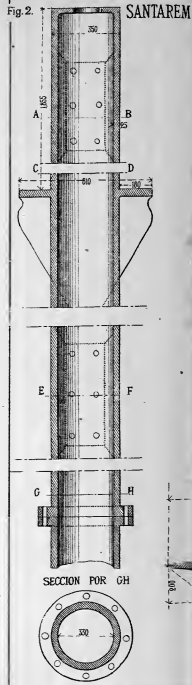
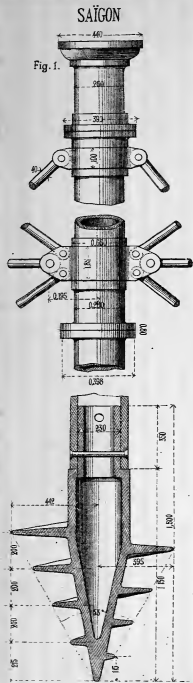


Fig. 1. (MITCHELL)

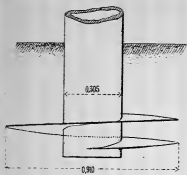


Fig. 2. (AMBERES)

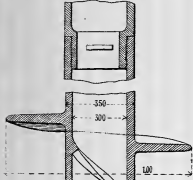


Fig. 3. (MARATECA)

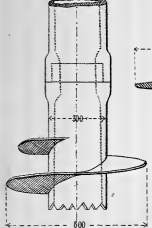


Fig. 4

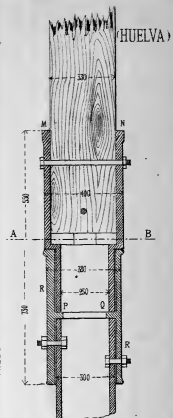


Fig. 5 SECCION POR AB



Fig. 6.

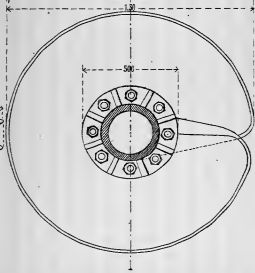
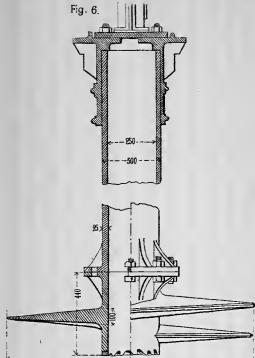


Fig. 7. (ZUMAYA)

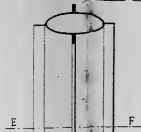


Fig. 8.

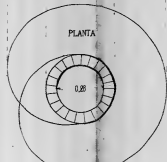
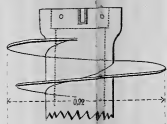


Fig. 9.



Fig. 10.

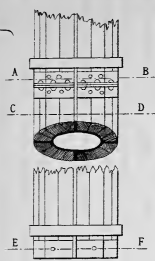


Fig. 11. SECCION POR AB

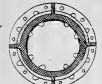


Fig. 12. SECCION POR CD



Fig. 13 SECCION POR EF

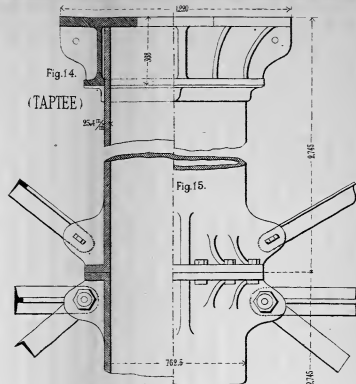
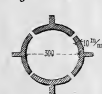


Fig. 16.

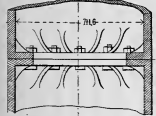


Fig. 17.

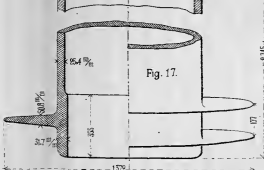
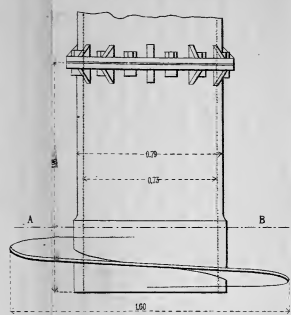
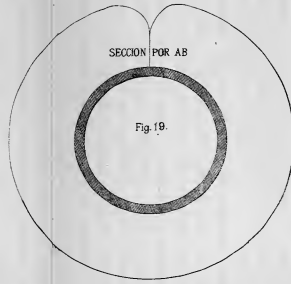


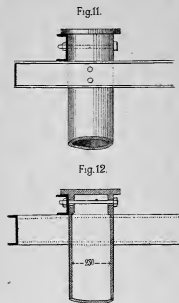
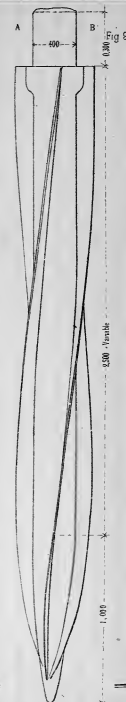
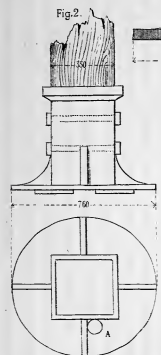
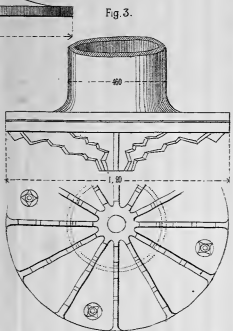
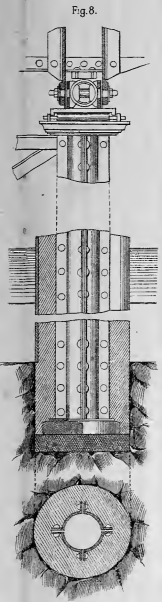
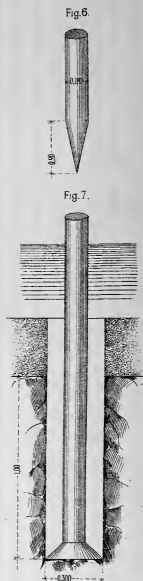
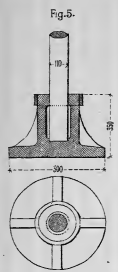
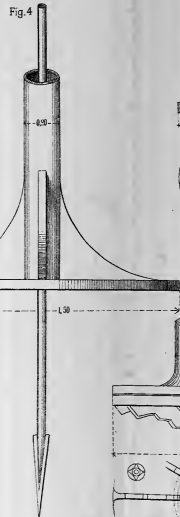
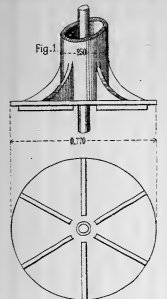
Fig. 18. (KONISBERG)



SECCION POR AB

Fig. 19.

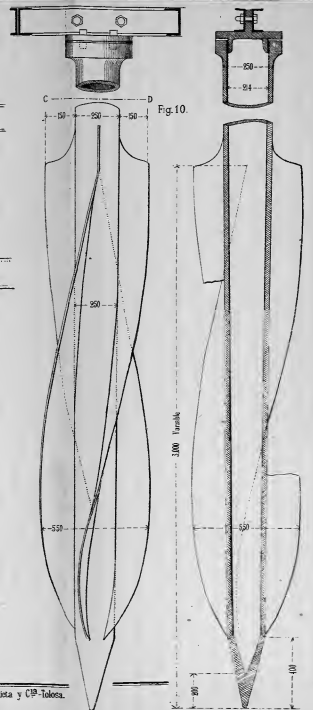
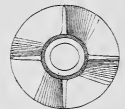




SECCION POR AB



SECCION POR CD



PUENTE SOBRE EL RIO MARATECA.

SECCIÓN TRASVERSAL POR UNA PALIZADA.

Fig. 1.

EJE DEL PUENTE.

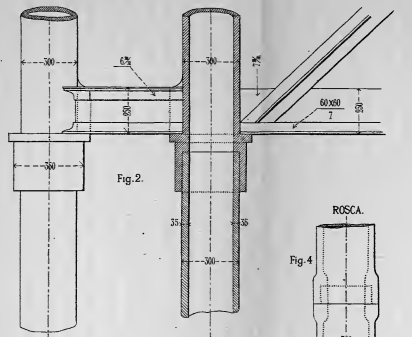
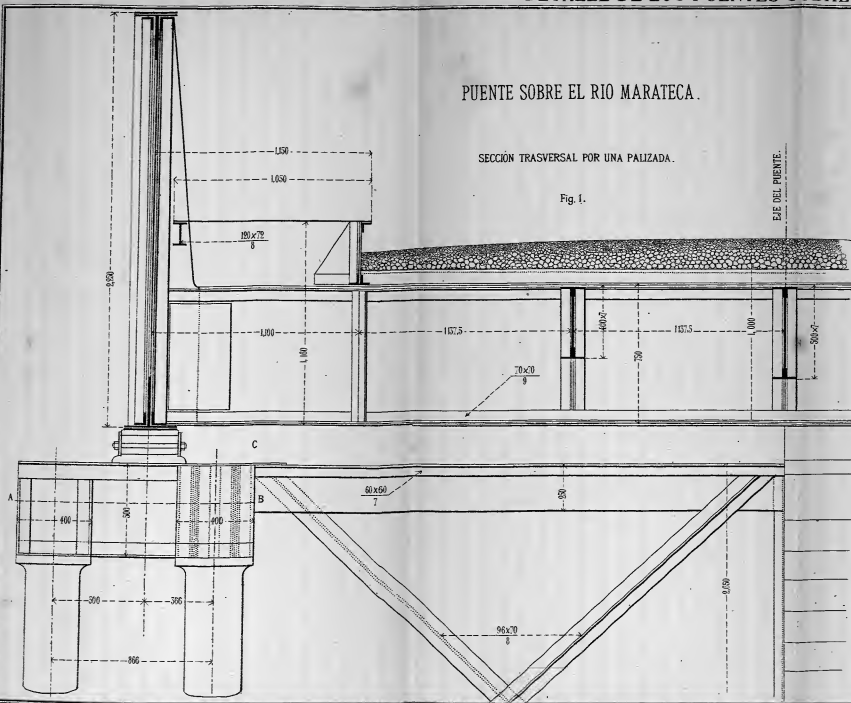


Fig. 2.

ROSCA.

Fig. 4.

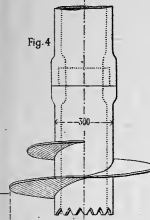
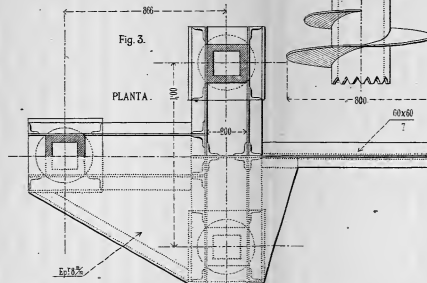


Fig. 3.

PLANTA.



PUENTE DE ZEVIO EN VERONA.

Fig. 5.

ALZADO DE UNA PALIZADA.

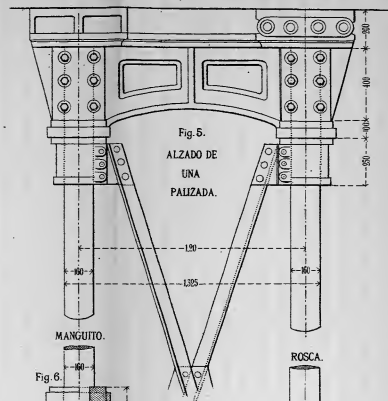
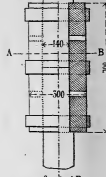


Fig. 6.



Sección A-B

Fig. 7.

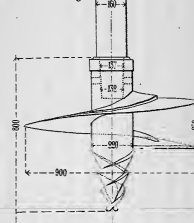
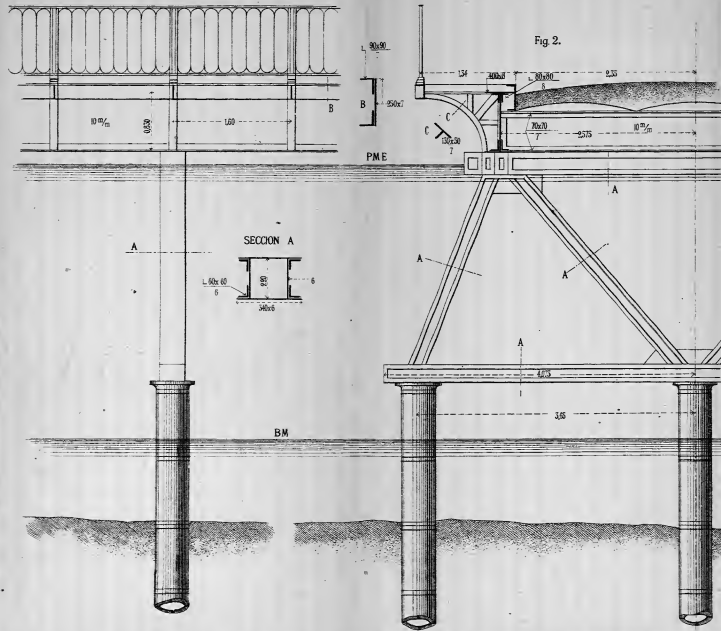


Fig. 1.

PUENTE SOBRE LA REGATA IRUBIDE



PUENTE SOBRE EL RIO UROLA

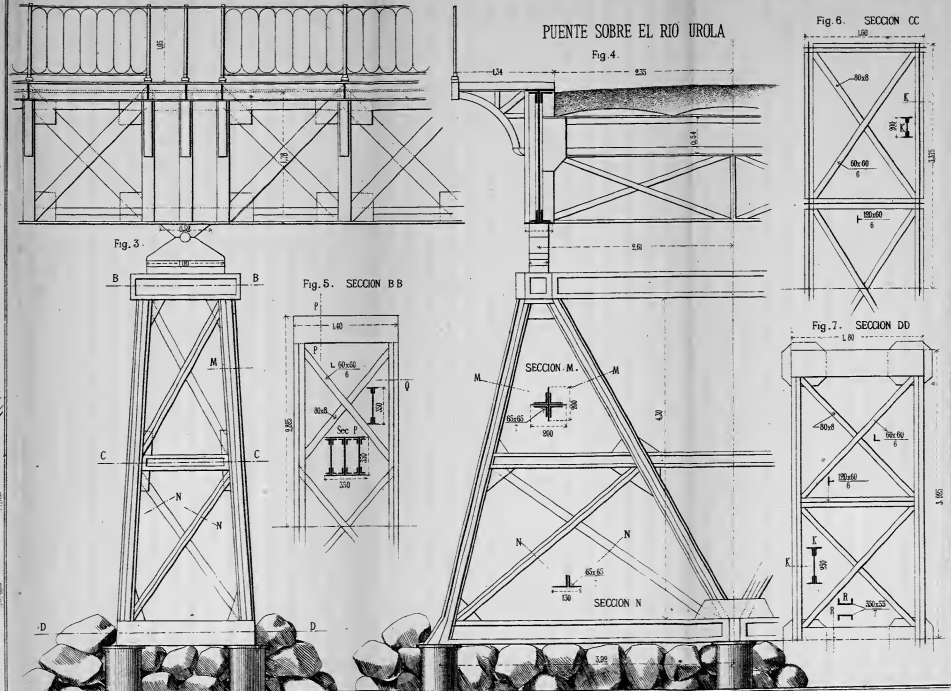


Fig. 6. SECCION CC

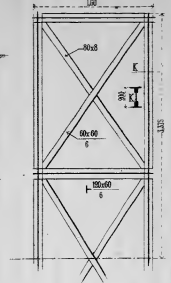
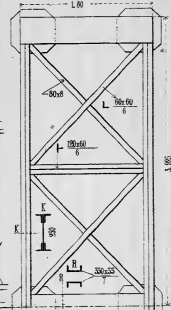
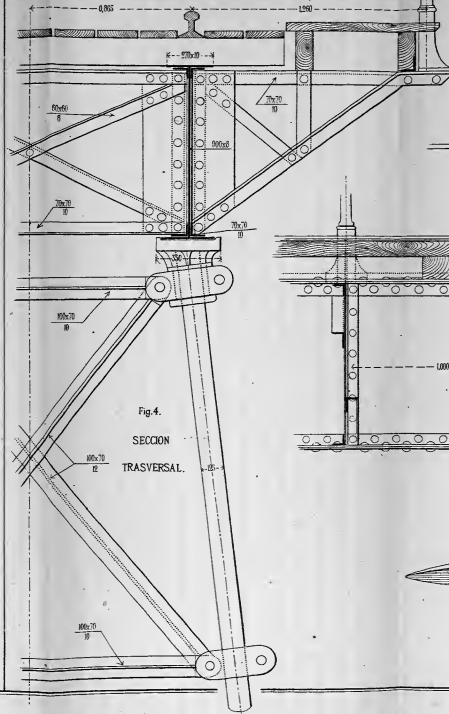
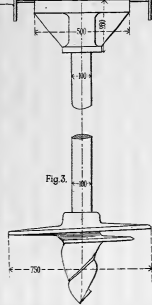
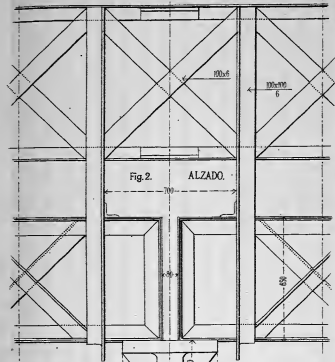
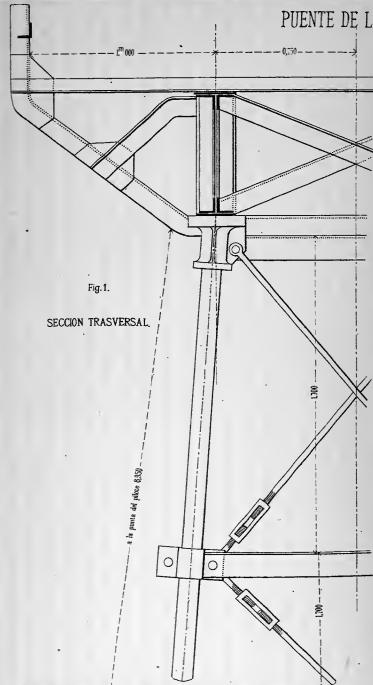


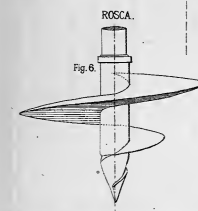
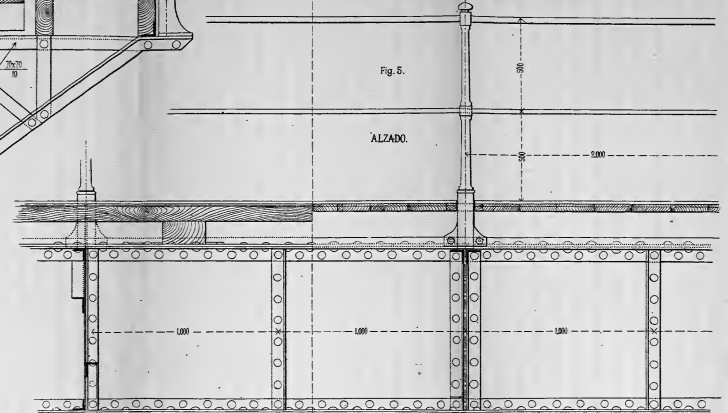
Fig. 7. SECCION DD



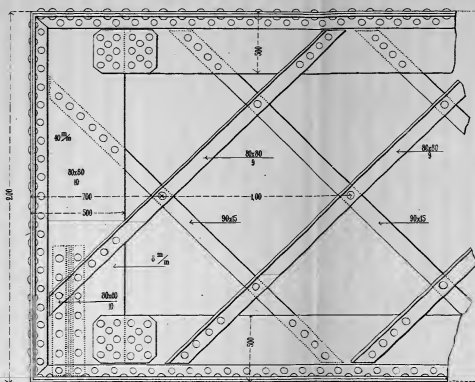
PUENTE DE LEZA - PORTUGAL



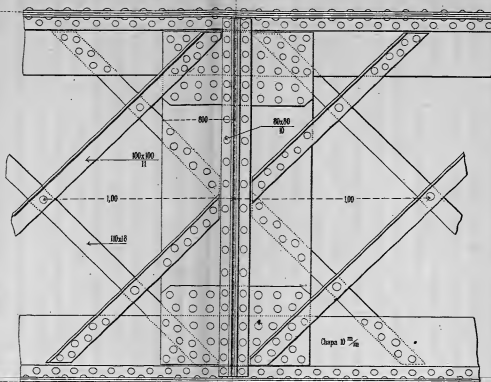
PUENTE SOBRE EL RIO MUGA - GERONA



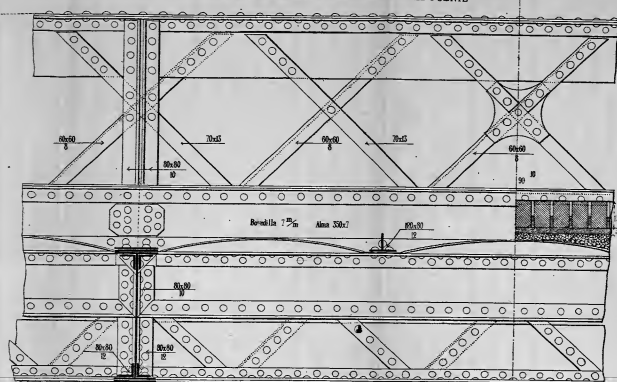
ALZADO DEL ESTREMO DE LA VIGA



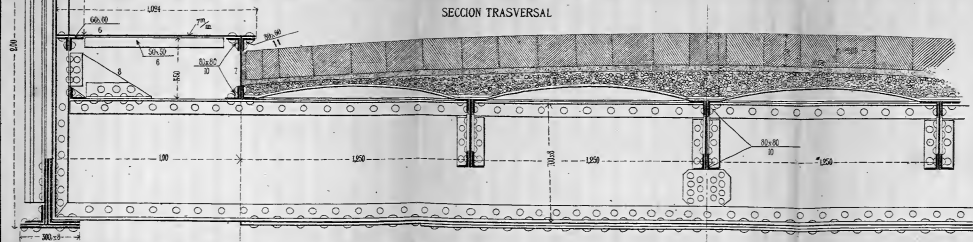
ALZADO EN LA PILA



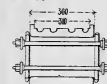
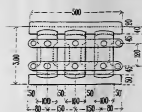
SECCION LONGITUDINAL EN EL CENTRO DEL PUENTE



SECCION TRASVERSAL



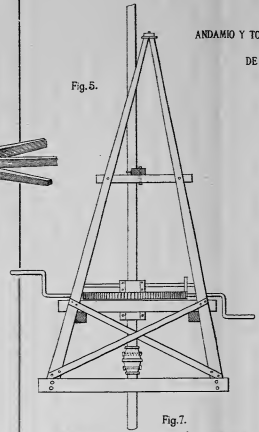
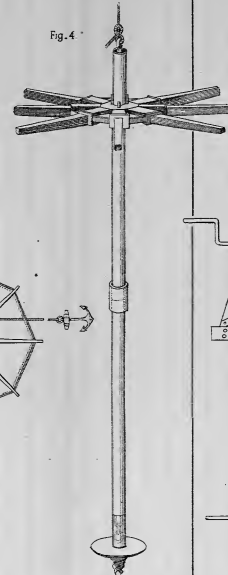
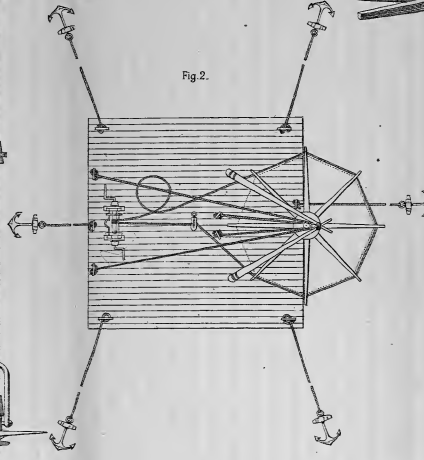
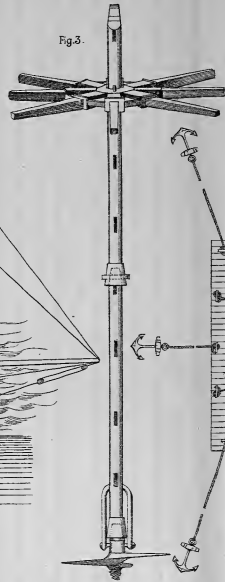
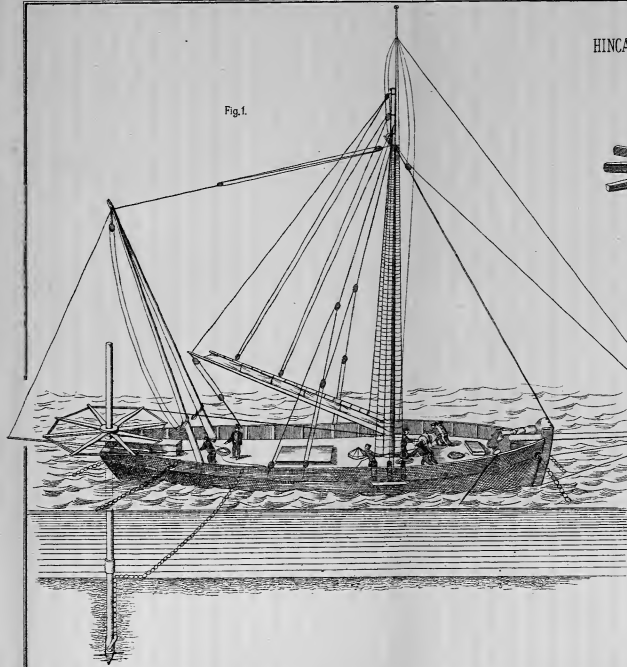
PLACAS APOYOS CON RODILLOS



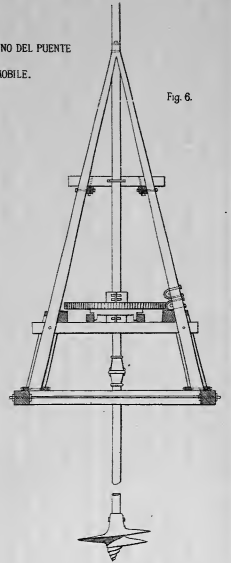
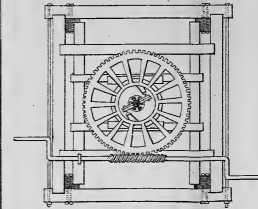
PLACAS FIJAS



HINCA DE LAS ROSCAS PARA BOYAS



ANDAMIO Y TORNO DEL PUENTE DE MOBILE.



ANDAMIO DEL PUENTE SOBRE EL RIO MUGA

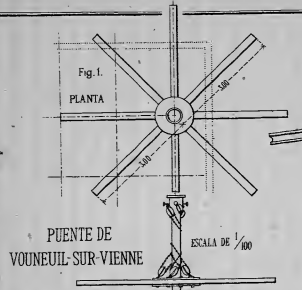


Fig. 4. FRENTE.

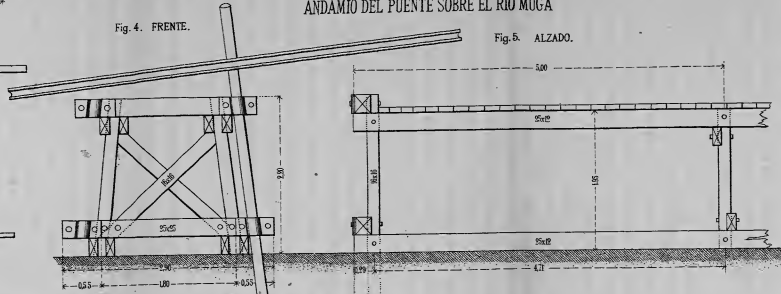


Fig. 5. ALZADO.

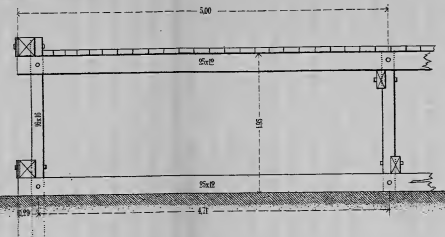
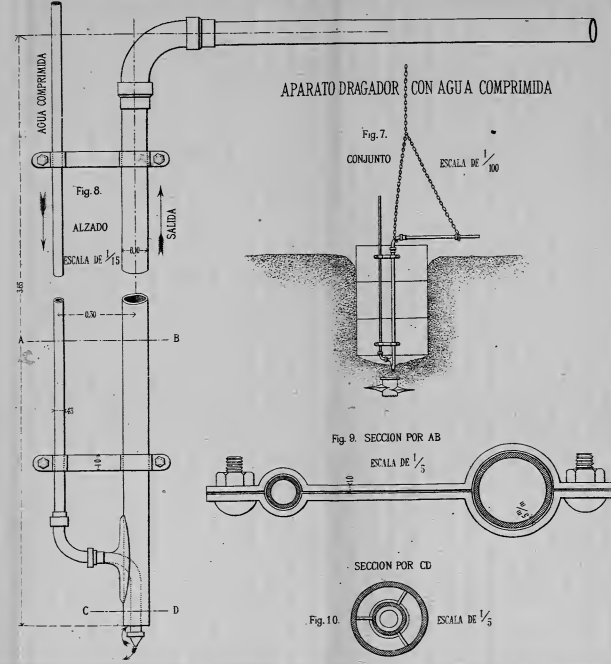
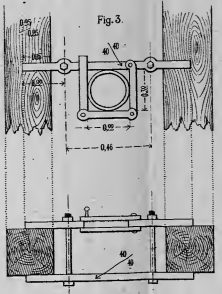
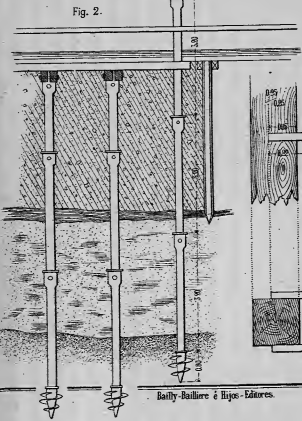
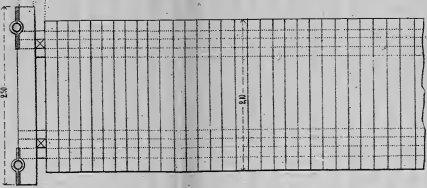


Fig. 6. PLANTA.



MUELLE DE COURTOWN (IRLANDA)

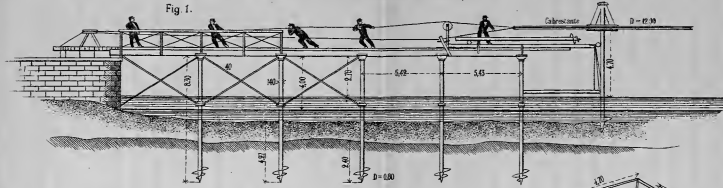


Fig 2

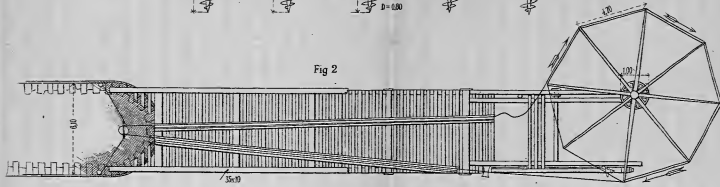


Fig 4

MUELLE DE VIGO
ESCALA DE 1/200

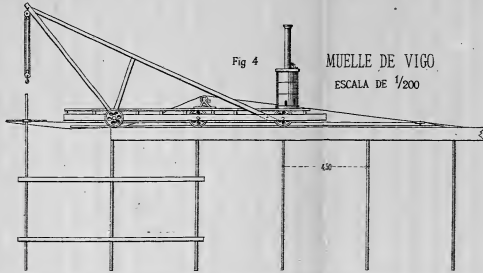


Fig 5

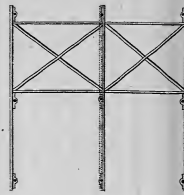
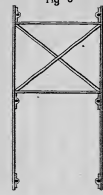


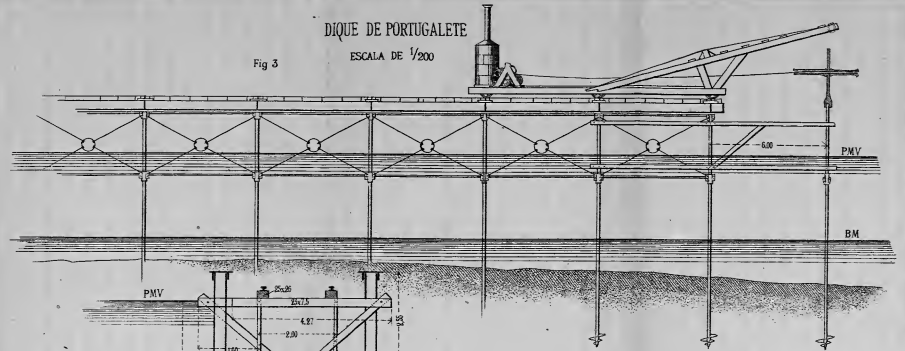
Fig 6



DIQUE DE PORTUGALETE

Fig 3

ESCALA DE 1/200



MUELLE DE LA RABIDA
ESCALA DE 1/100

Fig. 7. PLANTA

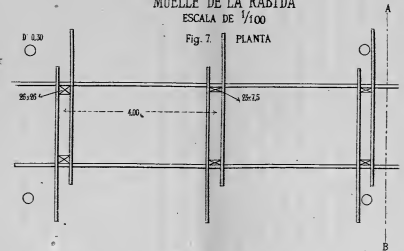


Fig. 8.

SECCION POR AB

