

PERMEABILIDAD
Llenos - vacíos

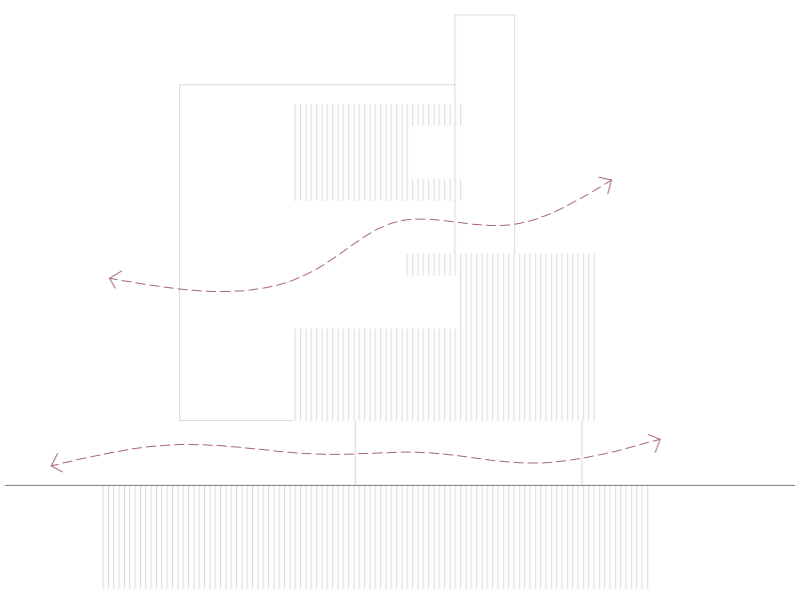

VENTILACIÓN
Natural cruzada y mecánica

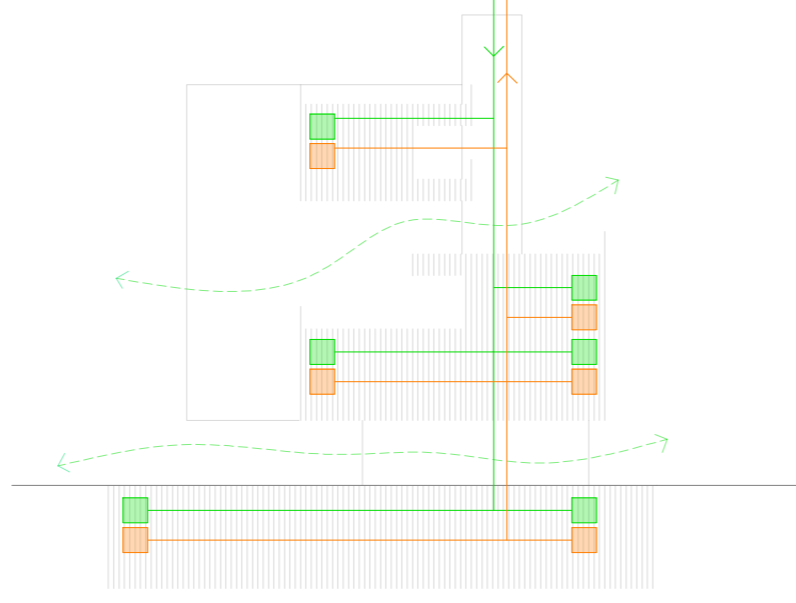

HUERTOS URBANOS
Productos km 0

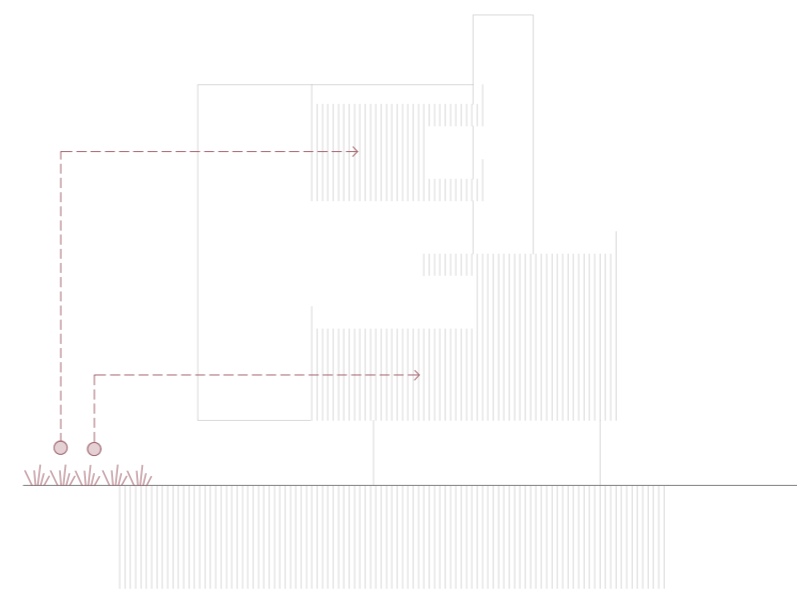

PUESTA A TIERRA
Pararrayos

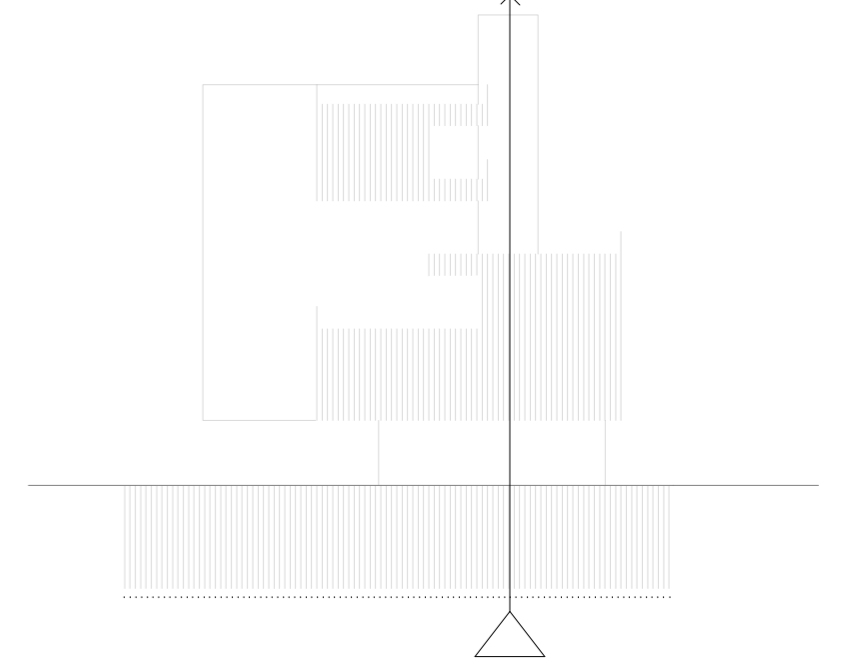

CONTROL SOLAR
Lamas

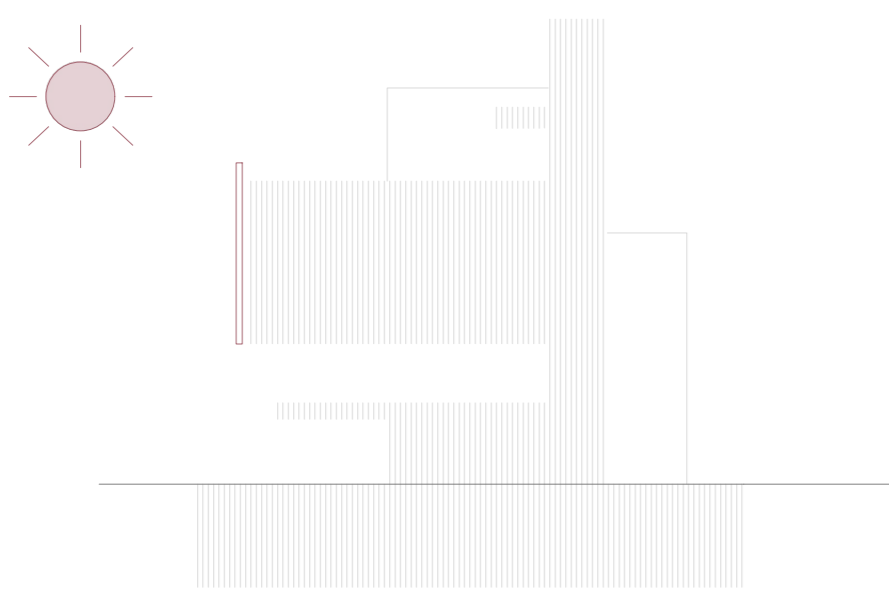

CLIMATIZACIÓN Y ACS
Aerotermia

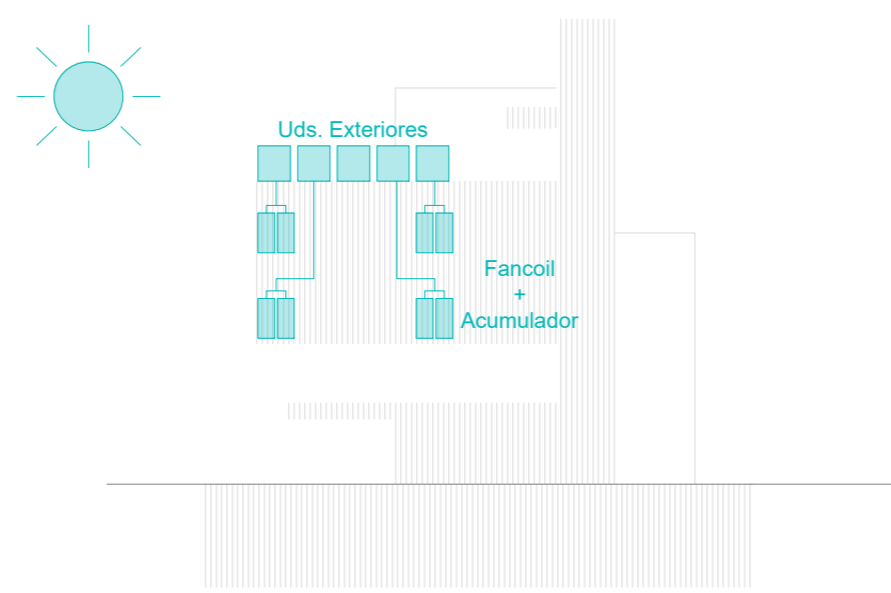

CICLO DEL AGUA
Pluviales

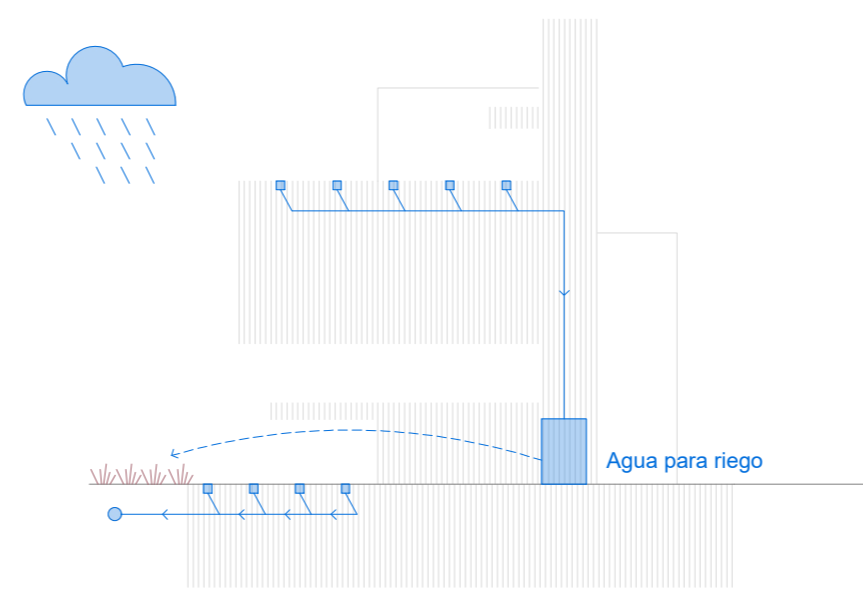

SANEAMIENTO
Residuales

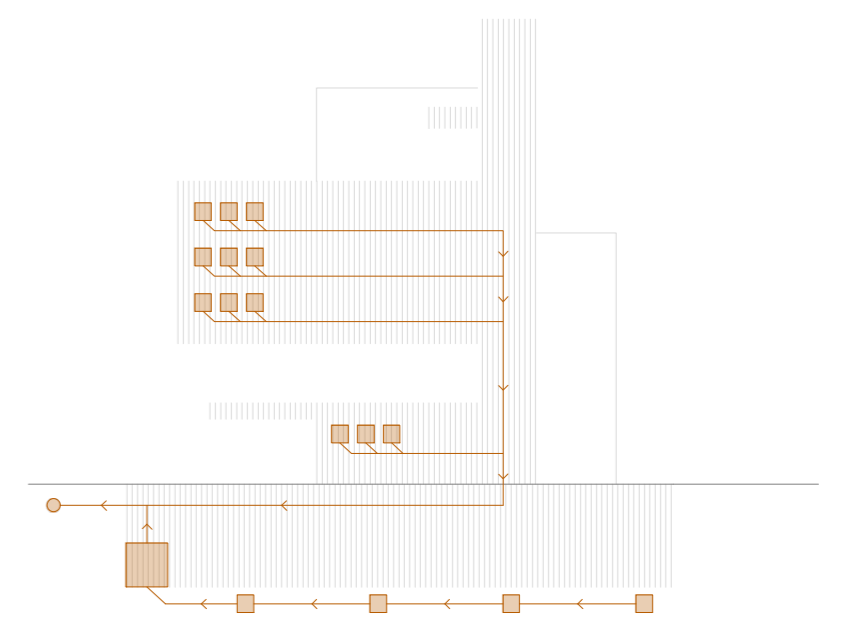

TRAZADO
Patinillos verticales

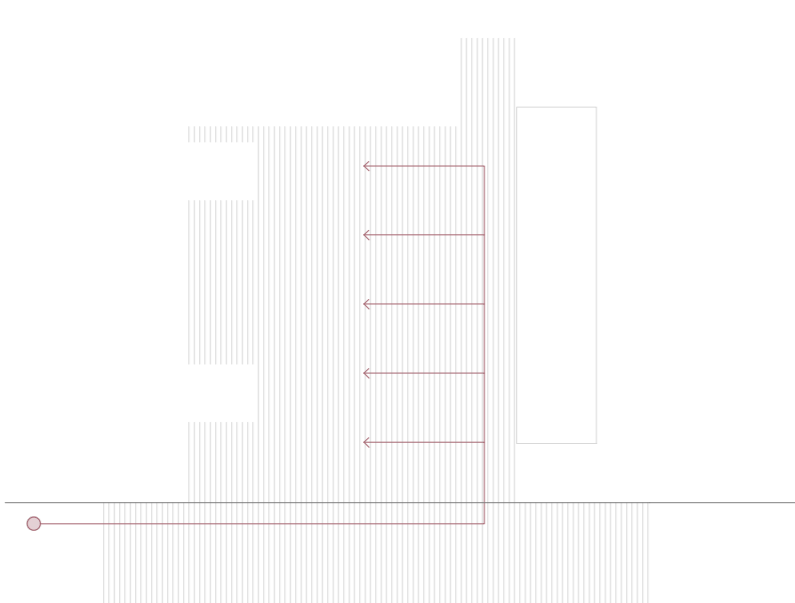

FONTANERÍA
1 Centralización

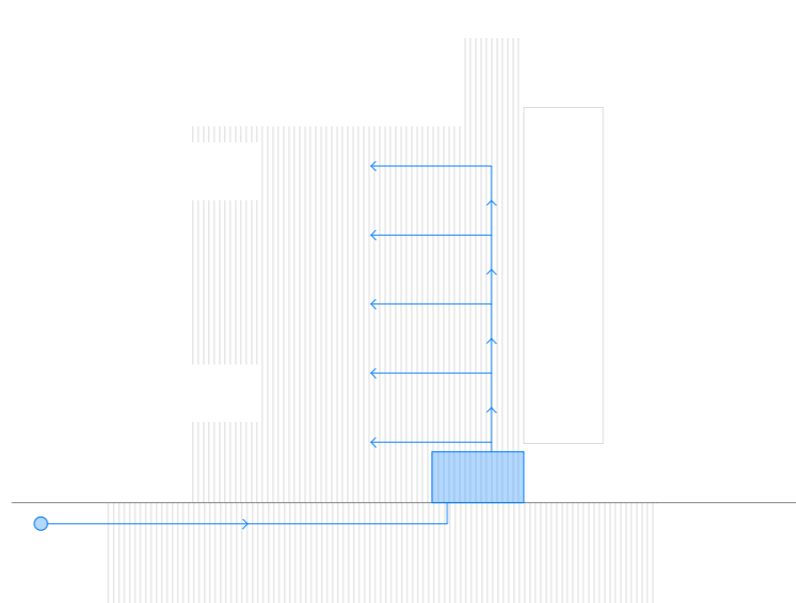

ELECTRICIDAD
2 Centralizaciones

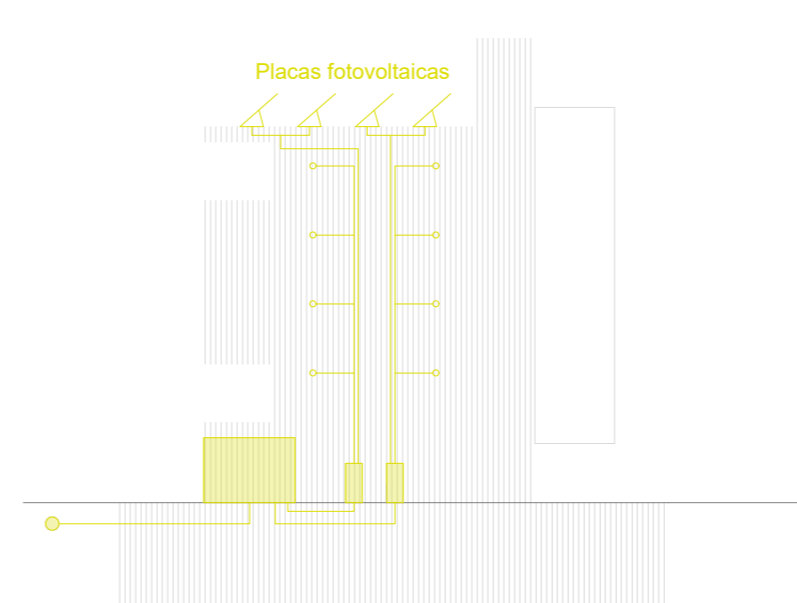

TELECOMUNICACIONES
1 RITI + 1 RITS

