

Monte-Carlo-based simulation and investigation of 230 kV transmission lines outage due to lightning

eISSN 2397-7264

Received on 27th June 2019

Revised 9th October 2019

Accepted on 16th October 2019

E-First on 11th February 2020

doi: 10.1049/hve.2019.0147

www.ietdl.org

Ehsan Karami¹ ✉, Ahmad Khalilinia², Afshar Bali², Kumars Rouzbehi³

¹Electrical Engineering Department, Sharif University of Technology, Tehran, Iran

²West Regional Electric Company, Kermanshah, Iran

³Department of System Engineering and Automatic Control, University of Seville, 41004 Seville, Spain

✉ E-mail: ehsan.karami@ee.sharif.edu

Abstract: Here, using the probabilistic evaluation based on the Monte Carlo method, back-flashover rate and shielding failure flashover rate of 230 kV overhead transmission lines in the western regions of Iran are evaluated. To such an aim, first, the number of thunderstorm days per year is collected from the reported weather information in order to determine the ground flash density. Then, using MRU-200 equipment, the tower-footing resistance of several towers is measured. Matlab® software is used in order to produce lightning surges considering its probabilistic nature and randomly distribution on the ground to evaluate striking distance based on the geometric model. Then, calculated parameters are transferred to EMTP-RV software by establishing a link to perform the transient simulation and report the results for modelled 230 kV transmission line. Finally, considering IEEE-1243 standard, it is shown that due to high ground flash density, using 230 kV tower with one shield wire is not sufficient to protect the line against lightning phenomena.

1 Introduction

Lightning is a well-known source of overvoltage and one of the main reasons for insulation breakdown in both transmission and distribution lines. This can make the operators and customers incur expenses due to the increase in maintenance services, the need for replacement of damaged equipment and the cut of electricity due to line outages [1]. Generally, the shield wires are used in order to protect the transmission lines against overvoltages produced by lightning phenomena. However, in some cases, using shield wires is not enough as there is still a probability of insulation failure following back-flashover on the regions with high ground resistance. Furthermore, there is a probability of shielding failure which can result in flashover across the line insulators causing insulation breakdown [2]. Considering the protection of transmission lines using shield wires, appropriate design of tower, number of shield wires and their location with respect to phase wires is vital.

A review of the literature shows that extensive studies have been carried out on the lightning performance of the transmission lines in order to improve the performance of the lightning protection [3–7]. In [2–5], simple linear or nonlinear resistors have been used to model the grounding system. On the other hand, a systematic approach has been proposed in [8, 9], according to which the inclusion of wideband model of grounding systems into the EMTP-like tools is possible. However, in these research studies, effects of environmental factors are not considered in detail and the statistical nature of the lightning is not included.

Different research studies have focused on the calculation of shielding failure rate and determining the shield angle of shield instruments. To such an aim, an electro-geometric model, which is based upon the striking distance as a function of lightning current, has been created and improved [10–12]. In [13], an improved electro-geometric model based on the consideration of upward corona leader system has been introduced. It is worth noting that the electro-geometric model is the most commonly used technique for determining the shielding failure rate and also the evaluation of lightning protection system designing. However, the electro-geometric model is not suitable for 500 kV and above extra high voltage (EHV)/ultra high voltage (UHV) transmission lines due to neglecting the upward leader from the conductors [14].

As reported by West Regional Electric Company in Iran, 230 kV lines outage due to lightning is a high value. Therefore, in this study, by using the reported statistical weather information regarding the number of thunderstorm days and also measuring tower-footing resistance, the operation of 230 kV transmission lines against lightning is investigated. In order to take into account the statistical features of lightning surges in the produced overvoltages, the Monte Carlo simulation method is employed. Moreover, based on the electro-geometric model, strike distances along with lightning characteristics are generated in Matlab®. By establishing a link, these data are then transferred to EMTP-RV to perform transient simulation and evaluate effects of the lightning on 230 kV transmission lines. Considering the obtained results and recommended values in IEEE-1243, it is shown that due to a high value of ground flash density, using one shield wire does not provide appropriate protection against lightning surges.

The main contributions of the paper are:

- Using weather information to obtain accurate results for ground flash density.
- Measuring tower-footing resistance for evaluating its effects on lightning performance.
- Using the Monte Carlo simulation method to take into account the statistical features of the lightning in a wide range.
- Using the electro-geometric model to determine the striking distance using Matlab® software. Establishing a link and performing the transient simulation in EMTP-RV.
- Comparing the results with IEEE-1243 to investigate the performance of the lightning protection system in the reduction of shielding failure flashover rate (SFFOR).

2 Meteorological studies and determination of isochronic level

West Regional Electric Company in Iran is responsible for the design, operation and maintenance of electrical systems in Kermanshah, Kurdistan and Ilam provinces. The total length of 230 kV transmission lines in these provinces is equal to 2646 km and according to the reports, in the period 2012–2017, the average value of these lines outage due to shielding failure is 1.17/100 km

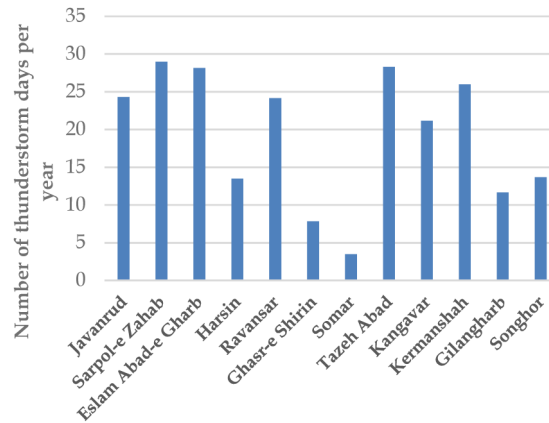

Fig. 1 Average value number of thunderstorm days per year in Kermanshah province (2012–2017)

Table 1 Ground flash density using Eriksson equation

Kermanshah	N_G	Kurdistan	N_G	Ilam	N_G
Javanrud	2.16	Saqquez	1.46	Ilam	2.85
Sarpol-e Zahab	2.69	Sanandaj	2.42	Mehran	0.91
Eslam Abad-e Gharb	2.59	Bijar	1.82	Dehloran	1.28
Harsin	1.03	Zarneh	1.93	Dareh Shahr	0.57
Ravansar	2.14	Marivan	2.99	Ivan	1.24
Ghasr-e Shirin	0.52	Ghorveh	1.75	Lomar	1.26
Somar	0.19	Baneh	4.33	Sarableh	1.01
Tazeh Abad	2.61	Kamyaran	0.89	Abdanan	1.65
Kangavar	1.81	Hezar Kanian	1.61	—	—
Kermanshah	2.35	—	—	—	—

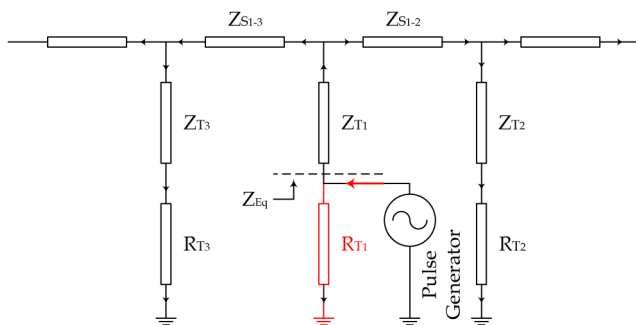

Fig. 2 Measuring tower-footing resistance

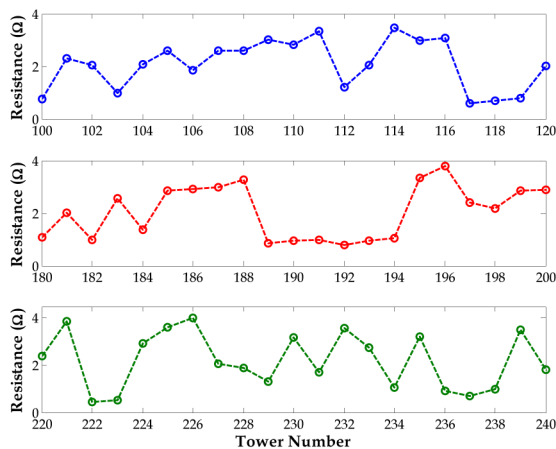

Fig. 3 Measured tower-footing resistance

year. Fig. 1 shows the average value number of thunderstorm days per year in different cities of Kermanshah province during 2012–2017 according to the reported weather information. These data are also available for Kurdistan and Ilam provinces. Considering the

Eriksson equation, the ground flash density is calculated as follows:

$$N_G = 0.04T_d^{1.25} \quad (1)$$

where T_d is the number of thunderstorm days per year. Table 1 lists the ground flash density for different provinces based on (1). As can be seen in Table 1, the ground flash density in ten cities is >2 which is known as a high value [15]. It should be noted that for 230 kV the transmission lines number of outages is 7/year for both Kermanshah and Ilam while this value is equal to 17/year for Kurdistan.

3 Measuring of tower-footing resistance

In order to measure the tower-footing resistance, the four-pole method is used. This method is recommended in the case of measurements of earth resistance with very low values. It permits to eliminate the influence of the test leads resistance over the result of the measurement [16]. The measurements are conducted using MRU-200 device. It is worth noting that since under study 230 kV transmission lines was in operation, earth impedance measurement was used to measure the tower-footing resistance accurately while minimising effects of shield wires. In this case, $4 \mu\text{s}/10 \mu\text{s}$ surge is produced by the device and due to the low impedance path through tower-footing resistance shown in Fig. 2, approximately. All current flows through this path since $R_{T1} \ll Z_{Eq}$. Impedance is measured according to the ratio of peak value of voltage and current. It should be noted that the effect of the parallel paths is negligible since the produced surge is eliminated in shield wires due to damping.

In this study, 63 towers were selected in Sanandaj–Chamran–Cheshmeh Sefid 230 kV transmission line in order to measure the tower-footing resistance. Fig. 3 depicts the numerical measurement results for different towers. According to the measurement results, the maximum value of tower-footing resistance is equal to 4Ω , which is used in the simulations. Moreover, it is worth noting that in IEC 62305-3, it is mentioned that 10Ω is an appropriate earth

Table 2 Lightning parameters [19]

Parameter	Average value	Standard deviation
maximum current (kA)	31.1	0.48
front time (μ s)	3.83	0.55
time to half value (μ s)	77.5	0.58

resistance; however, this value is very general and is not limited to transmission lines.

4 Monte Carlo

Monte Carlo simulation is a type of simulation that relies on the repeated random sampling and statistical analysis in order to compute the results. It should be noted that this simulation method is closely related to random experiments, experiments for which the specific result is not known in advance. In this context, the Monte Carlo simulation can be considered as a methodical way of doing the so-called what-if analysis. In summary, the Monte Carlo simulation is a very useful mathematical technique for analysing uncertain scenarios and providing a probabilistic analysis of different situations [17]. The main assumption is that population mean of $g(X)$ is estimated by a sample mean as follows:

$$E[g(X)] \simeq \frac{1}{n} \sum_{t=1}^n g(X_t) \quad (2)$$

where n is the number of samples and it is under control. If the samples are independent, laws of large numbers ensure that the approximation can be made as accurate as desired by increasing the sample size. In this paper, the Monte Carlo simulation method considering 30,000 samples is used to include the statistical characteristics of lightning phenomena into the performed analysis [18].

5 System modelling

EMTP-RV software as a very powerful and flexible tool is used in order to simulate 230 kV transmission line. It should be noted that 80 MW load with power factor of 0.9 lag flows through the transmission line. Moreover, upstream and downstream networks are modelled using an ideal source with balanced voltages. In addition, a variable uniformly distributed in the range 0–360° simulates the phase angle of the impressed power frequency voltages.

5.1 Lightning surge

In EMTP software, I CIGRE device is used to model the current shape of a lightning stroke for accurate calculations of lightning performance. The current source, which is used to model lightning surge, is in parallel with a 1 k Ω resistance to consider the channel impedance. In this paper, 30,000 lightning surges are produced considering statistical characteristics reported in [19], which are also listed in Table 2.

5.2 Transmission line

The frequency-dependent line model is used to accurately model Sanandaj–Chamran–Cheshmeh Sefid 230 kV transmission line by taking into account the frequency dependence of series resistance and inductance of the line per unit length*** [20]. In this model, the data of phase and shield conductors along with physical distances are used as required input data. It should be noted that the vector fitting method is used for approximating the simulated frequency response with a rational model is as follows:

$$f(s) = \sum_{m=1}^N \left(\frac{r_m}{s - a_m} \right) + d + se \quad (3)$$

Moreover, the frequency representation in the form of (3) is converted to the state-space equation. In (3), d and e are optional

[21]. Unknown coefficients are identified so that the least-squares distance between $f(s)$ and the data samples is achieved, which requires an iterative process by replacing initial poles by the relocated poles until the convergence is reached. It is worth noting that the line span is 402 m and its length is 187.2 km. Conductor type is Canary in which diameter is 29.51 mm and its resistance at 20°C is 0.06332 Ω /km. The same conductor is used for a shield wire.

5.3 Tower

In this paper, each segment of the tower between crossarms (four sections) is represented by using the lossless line model [22]. The used tower in the under-study transmission line is depicted in Fig. 4 in which all numerical values are in metre. Moreover, considering [22], tower surge impedance is calculated by $60 \ln(\sqrt{2} \sqrt{(h/r)^2 + 1})$. According to this equation, noting that h (tower height) and r (tower base radius) are 49.9 and 5.75 m, respectively, the surge impedance of the tower is equal to 150.84 Ω . More details regarding tower grounding system and number of included towers and line lengths at two ends are provided in the Appendix.

5.4 Insulator

One of the most suitable methods for the evaluation of the moment and level of arcing of spark gaps after a lightning strike is the integral method. The insulation is modelled by

$$\int_{t_0}^t [|v_{\text{gap}}(t)| - v_0]^k > D \quad (4)$$

Flashover occurs when the above integral becomes greater or equal to D . t_0 is the time-point from which v_{gap} became greater than v_0 . When the voltage v_{gap} goes below v_0 the integral is reset. The gap is an ideal open switch before flashover and becomes an ideal closed switch after the flashover. More information is provided in [23]. Considering height of the insulator is about 300 cm and modifying the reported values in [24], in the under-study transmission system, numerical values for v_0 , k and D are 1300 kV, 1.02 and 0.036506, respectively.

6 Striking distance

Several researchers have contributed to the electro-geometric model of the last step or striking distance of the lightning flash [25]. As the downward leader approaches the earth, a point of discrimination is reached for a final leader step. The electro-geometric model portrays this concept with the use of striking distances. Other models model the upward-directed leaders from objects. In IEEE-1243 [15], the following striking distance equations are recommended:

$$r_c = 10I^{0.65}$$

$$r_g = \begin{cases} [3.6 + 1.7 \ln(43 - h)]I^{0.65}, & h < 40 \\ 5.5I^{0.65}, & h \geq 40 \end{cases} \quad (5)$$

where r_c is the striking distance to the phase conductor, r_g is the striking distance to the ground, I is the stroke current and h is the average conductor height in metres, given by the height at the tower minus two-thirds of the midspan sag. These distances are depicted in Fig. 5.

If a downward leader (having a prospective current I for which the arcs were drawn) touches the arcs between M and N , the leader

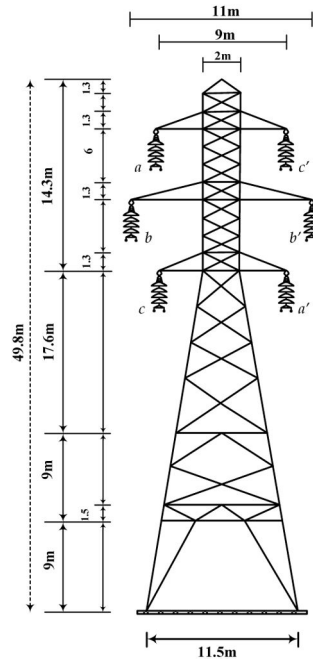

Fig. 4 Used tower in Sanandaj–Chamran–Cheshmeh Sefid 230 kV transmission line

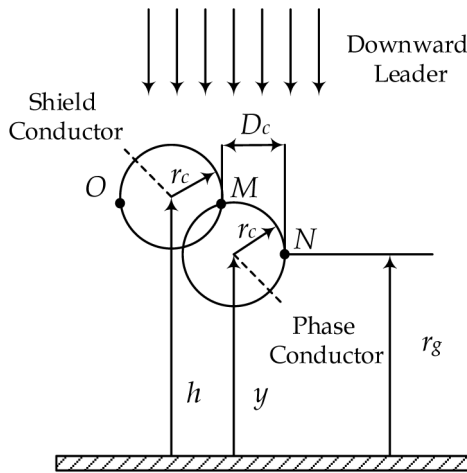

Fig. 5 Exposed distance for final jump in electro-geometric model

will strike the phase conductor. If the leader touches between M and O , it will strike the shield wire. If all leaders are considered vertical, the exposure distance for a shielding failure is D_c . In the two-conductor case shown, there would only be a shielding-failure rate (SFR) on one side equal to $N_G \times D_c \times L$, given for specific value of current for a line of length L .

7 Simulation procedure

In order to investigate the performance of Sanandaj–Chamran–Cheshmeh Sefid 230 kV transmission line against lightning with only one shield wire, a channel with length of 450 m and width of 712 m is used. Moreover, for considering the worst case, it is assumed that all the lightning strokes are present in the channel. Matlab® software is used to produce lightning waveforms with characteristics listed in Table 2, determining the strike distances according to IEEE-1243 and also producing the phase angle of the source. These parameters are then transferred to the EMTP-RV software to perform the transient simulation and investigate the performance of the transmission line against lightning overvoltages considering models described for each equipment in Section 5. The flowchart of the simulation procedure is illustrated in Fig. 6. As shown in this figure, at first, output results of Matlab® are used in EMTP-RV. Then, results of EMTP-RV are analysed to investigate the line outages. It is worth noting that simulation time in EMTP-RV is 1 ms with time step of 1 ns.

8 Calculation of SFFOR and back-flashover rate (BFR)

In this paper, considering the described procedure in Fig. 6, SFFOR per 100 km year is calculated as follows [3]:

$$\text{SFFOR} = N_G \times 100 \times d \times \frac{F_P}{N} \quad (6)$$

N is number of runs and d is the maximum width of impact area that corresponds to the maximum peak current magnitude of the first stroke generated by the Monte Carlo simulation. Moreover, F_P is the number of flashovers caused by strokes to the phase conductor.

In this paper, BFR per 100 km year is calculated as follows [3]:

$$\text{BFR} = N_G \times 100 \times d \times \frac{F_G}{N} \quad (7)$$

In this equation, F_G is the number of flashovers caused by strokes to the shield wire.

9 Tests and results

9.1 Using one shield wire

Considering Fig. 4 and the flowchart in Fig. 6, 30,000 lightning strokes are produced with characteristics listed in Table 2. Under this condition, 6774 lightning strokes strike to shield wire (22.58%), 643 lightning strokes terminate on upper phase conductors (2.14%) and the rest strike to the ground. It is worth noting that the minimum and maximum lightning currents that strike to the shield wire are 5.66 kA and 215.51 kA, respectively. Moreover, the minimum lightning current (or critical current I_C) and maximum current (I_{Max}) that strike to the phase conductors are 8.03 and 48.81 kA, respectively. Analysing these values in EMTP-RV reveals that 936 of 6774 lightning strokes (13.82%) lead to failure. In this case, the minimum value of lightning current that results in back-flashover or critical current (I_C) is 38.84 kA with front time of 2.99 μ s and time to half of 28.17 μ s. These results show that the performance of shielding against the lightning is not good so that 3.12% of the lightning strokes that strike to the considered channel lead to shielding failure. It is worth noting that 641 from 643 (99.69%) lightning strokes which strike on phase conductors cause failure. In this case, the minimum value of lightning current that results in failure or critical current is 8.03 kA

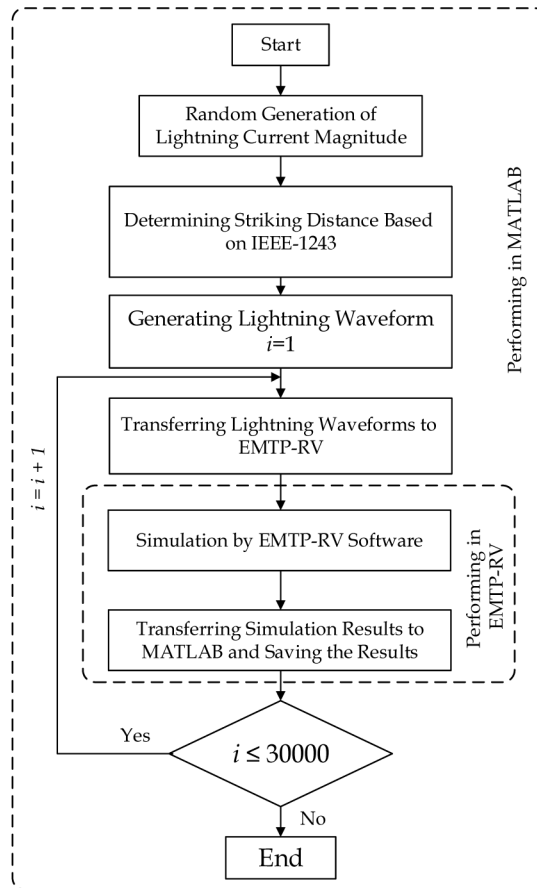

Fig. 6 Simulation procedure

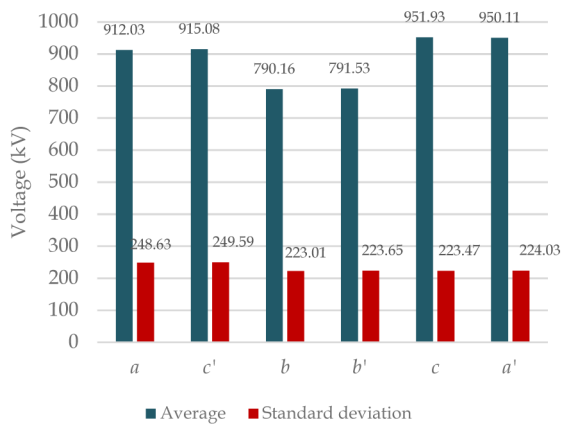

Fig. 7 Average and standard deviation of overvoltages – striking to shield wire

with front time of 1.3 μ s and time to half of 56.03 μ s. Figs. 7 and 8 depict the average value and standard deviation of overvoltages caused by lightning for terminating on shield wire and phase conductors, respectively.

Voltage for upper phases is higher due to the lightning strike; besides, in these phases, induced voltage is also high. However, induced voltage at lower phases is less and therefore, the voltage difference across the insulator could be high which leads to failure that can be seen in Fig. 7 for phase a' . As mentioned before, source at the sending end is assumed to be balanced and the angle of different phases is distributed normally. It is worth noting that for lower values of lightning current with higher probability of occurrence, the effect of a phase angle is more obvious. Regarding Figs. 7 and 8, it should be pointed out that due to symmetry in tower configuration and phase angle of different phases, it can be seen that overvoltages are symmetrical for phases with identical height.

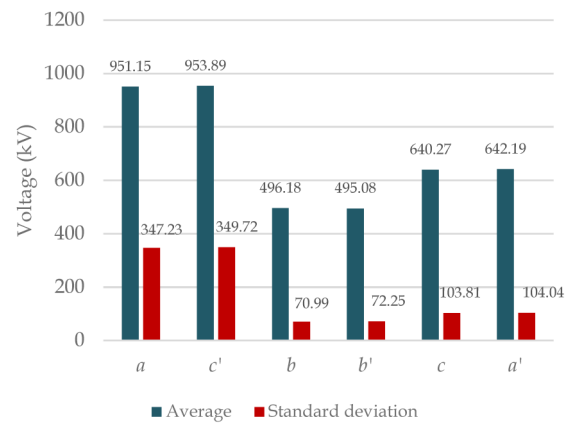

Fig. 8 Average and standard deviation of overvoltages – striking to phase conductors

According to the results, Table 3 is obtained. It should be noted that N_G is considered to be 1.4, which is the average value in under-study regions. It should be noted that with maximum lightning current of 215 kA, according to (5), d is equal to $10 \times 215^{0.65} = 0.328$ km. Based on the number of lightning strokes to phase conductor and shield wire, by using (6) and (7), SFFOR is equal to 0.9602 flashes/100 km year and BFR is 10.12 flashes/100 km year. It is worth noting that the obtained result for SFFOR is close to the reported value by West Regional Electric Company. As mentioned in Section 2, in the period 2012–2017, the average value of 230 kV transmission lines outage due to shielding failure is 1.17/100 km year.

According to IEEE-1243 (see Fig. 9), for $h = 49.9$ m, shielding angle of 34.69° and critical current of 8.03 kA, if N_G is equal to 0.1, SFFOR is close to 0.05/100 km year. However, for Sanandaj–Chamran–Cheshmeh Sefid 230 kV transmission line, SFFOR is 0.9842/100 km year, which is a very high value. This result is

Table 3 Required parameters to calculate line outage (one shield wire)

Parameter	Value	Parameter	Value
I_{CBFR}	38.84 kA	D_{CC}^a	8.0548
I_{CSFFOR}	8.03 kA	I_{max}	48.81 kA
h	49.9 m	isochronic level	26.5
L	182.7 km	N_G	1.4

^a D_{CC} is DC for I_C .

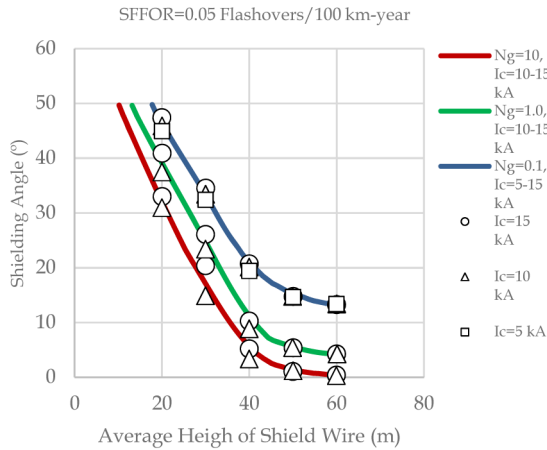
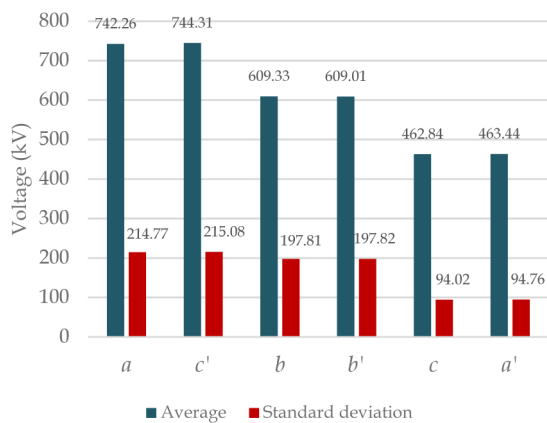
**Fig. 9** Shielding angles for constant SFFOR [15]**Fig. 10** Average and standard deviation of overvoltages – striking to shield wires

expected since due to the high value of N_G , using one shield wire does not provide the appropriate shielding angle for protection against lightning.

9.2 Using two shield wires

As mentioned before, using one shield conductor does not provide the appropriate protection against lightning surges due to a high value of ground flash density in the under-study area. Therefore, one of the best solutions to reduce outages because of lightning is employing more shield wires, which should be considered during the design process. Otherwise, adding new shield wires after the construction is almost impossible and other solutions like reduction of tower-footing resistance (if possible) or using line surge arrester should be considered.

Generally speaking, for constant height of the shield wire, if another shield wire is added to the tower structure, the shielding angle reduces and for the same value of critical current, SFFOR also reduces. In this case, significant reduction in the value of I_{Max} is expected. To such an aim, it is assumed that another shield wire is added to the tower so that the distance between two shield wires is 5.6 m and shielding angle of 14.98° is provided which is much $<34.69^\circ$ [26].

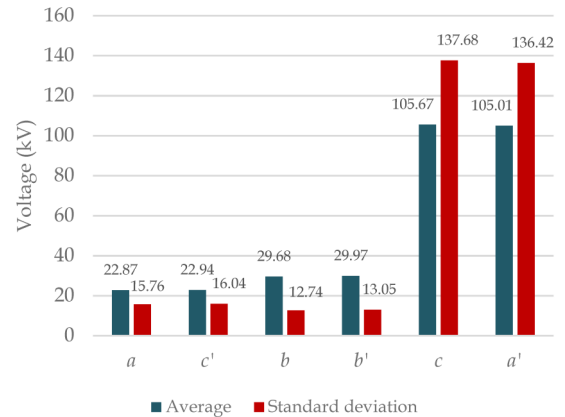
**Fig. 11** Reduction in average and standard deviation of overvoltages – striking to shield conductors

Following the same procedure performed in Section 9.1, it is concluded that 7818 lightning strokes terminate on shield wires (26.06%), 163 lightning strokes terminate on upper phase conductors (0.54%) and the rest strike to the ground which shows significant improvement in the protection of the line against lightning. It is worth noting that in this case, as expected, I_{Max} significantly reduces and is equal to 25.10 kA which shows $>90\%$ reduction in comparison with I_{Max} when only one shield wire is used. Consequently, reduction in overvoltages for striking lightning to the shield wires especially for upper conductors is expected. Fig. 10 depicts the average and standard deviation values of produced overvoltages when two shield wires are used. As can be seen in this figure, reduction in produced overvoltages for terminating on shield wires is obvious due to providing parallel path for lightning current to flow. Further details regarding the mathematical description of reduction in overvoltages are represented in Fig. 11 for each phase individually.

Results are summarised in Table 4. Under this condition, by using (6) and (7), SFFOR is equal; therefore, it is concluded that SFFOR is 0.2494/100 km year which is much less than SFFOR for one shield wire and closer to the recommended value by IEEE-1243.

10 Overvoltage and critical current for different number of shield wires

Obtained results in previous sections are based on failure in the system by considering statistical features of the lightning. This section investigates effects of increasing the shield wires on reducing the overvoltages in different parts and also increasing the lightning magnitude required to cause the flashover.

To examine the effects of shield wire on overvoltages in different phases, a 35 kA 1.2 μ s/50 μ s lightning waveform is terminated on the tower. It should be noted that simulation is started from the steady-state response and lightning strokes at $t=0$ s. Voltage waveforms of shield and phase conductors for both one shield wire and two shield wires are depicted in Figs. 12 and 13, respectively. According to these figures, as expected, it is clear that using two shield wires significantly reduces the produced overvoltages in different conductors. For instance, the peak voltage of shield wire reduces to 1393 kV from 1570 kV.

When only one shield wire is used, the minimum value of lightning magnitude, which causes back-flashover, is 54 kA with

Table 4 Required parameters to calculate line outage (two shield wires)

Parameter	Value	Parameter	Value
I_{CBFR}	91.41 kA	D_{CC}^a	1.7211
I_{CSFFOR}	8.03 kA	I_m	25.10 kA
h	49.9 m	isochronic level	26.5
L	182.7 km	N_G	1.4

^a D_{CC} is DC for I_C .

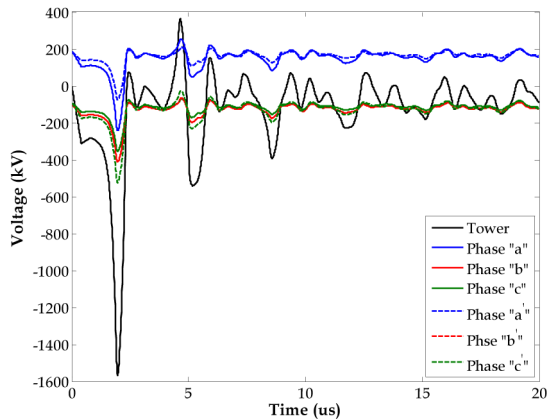
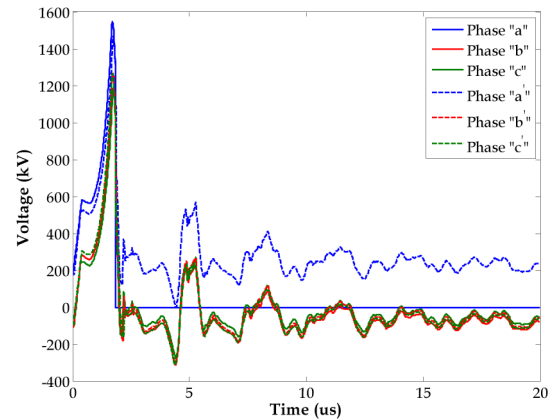
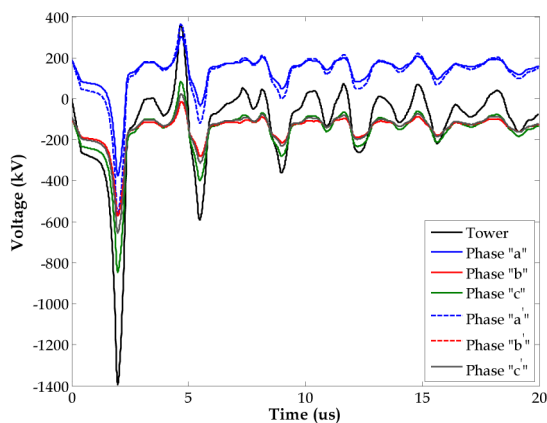
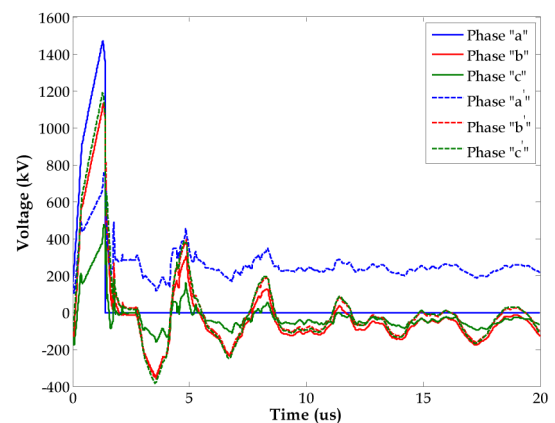
**Fig. 12** Overvoltage of different conductors – 35 kA lightning – one shield wire**Fig. 14** Overvoltage of different insulators – 54 kA lightning – one shield wire**Fig. 13** Overvoltage of different conductors – 35 kA lightning – two shield wires**Fig. 15** Overvoltage of different conductors – 83 kA lightning – two shield wires

probability of 19.11%. Overvoltages of this case are depicted in Fig. 14. As can be seen, at the time of 1.825 μ s, short circuit occurs in phase *a* when its voltage reaches 1545 kV. Consider using two shield wires, the minimum value of lightning magnitude, which causes back-flashover in this case, is 83 kA with probability of 7.17%. The results of this case are shown in Fig. 15. According to this figure, at the time of 1.405 μ s, short circuit occurs in phase *a* when its voltage reaches 1469 kV. It is worth noting that while the required current for flashover significantly increases, the occurrence probability of lightning with bigger magnitude reduces.

According to the results of this section, it is concluded that using two shield wires for under study 230 kV transmission line, significantly reduces overvoltages in different parts of the tower and the required lightning magnitude for leading to line outage considerably increases. The results of this section also emphasise on proper selection of shielding system at the design stage since due to practical limitations, shielding system modification by adding a new shield wire seems impossible especially for long transmission lines.

11 Conclusion

According to the reports by West Regional Electric Company, the average value of 230 kV lines outage due to lightning phenomena

is significant. Since 230 kV lines play an important role in the system stability and also in reliability, it was very important to analyse the shielding performance against lightning. In this paper, by using the Monte Carlo simulation method for considering statistical features of the lightning phenomena, outages of 230 kV transmission line in the western regions of Iran were investigated based on the reported weather information and measured footing resistance of towers using MRU-200 device. According to the reported weather information, the number of thunderstorm days in under-study regions is high which could greatly affect the number of line outages. Moreover, considering the measured tower-footing resistance, it is concluded that grounding system provides appropriate earth resistance.

By determining the strike distances along with characteristics of the lightning surge in Matlab®, results were transferred to EMTP-RV in order to investigate the transient performance of the system against lightning after proper modelling of system components. As expected and according to the reported values and also obtained simulation results, it was concluded that using one shield wire does not provide appropriate protection for 230 kV transmission lines against lightning surges since ground flash density in the under-study regions is a high value. Moreover, the calculated SFFOR was compared with recommended values by IEEE-1243. In addition, the performance of the line considering two shield wires was

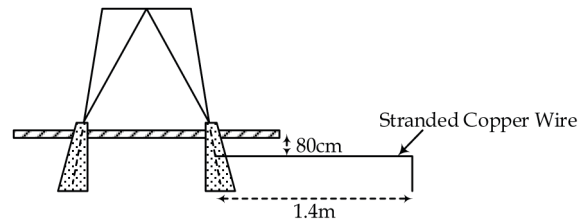

Fig. 16 Tower grounding system

investigated which showed that in this case, reduction in overvoltages and therefore the value of SFFOR is significant and this value is much closer to the recommended value by IEEE-1243.

Obtained results in this study show that the proper selection of number of shield wires along with providing appropriate grounding system is vital to minimise transient overvoltages resulted from lightning. These parameters should be considered in detail according to the under-study region at the design stage. It is worth noting that modifying tower-footing resistance can be done even while system is in operation. However, modifying shielding system, for instance, adding a new shield wire is practically impossible. In this case, surge arresters could be used, which are expensive components and should be properly selected. Therefore, determining the number of shield wires is the first solution for line protection against transient overvoltages.

12 Acknowledgments

This research was supported by the West Regional Electric Company, Iran, Kermanshah. The authors would like to thank their colleagues who provided insight and expertise that greatly assisted the research.

13 References

- [1] Hileman, A.R.: 'Insulation coordination for power systems' (Marcel Dekker, New York, USA, 1999)
- [2] Rahiminejad, A., Vahidi, B.: 'Fractal-based lightning model for shielding failure rate calculation of transmission lines', *IET Sci. Meas. Technol.*, 2018, **12**, (6), pp. 719–725
- [3] Martinez, J.A., Aranda, F.C.: 'Lightning performance analysis of overhead transmission lines using the EMTP', *IEEE Trans. Power Deliv.*, 2005, **20**, (3), pp. 2200–2210
- [4] Napolitano, F., Tossani, F., Borghetti, A., *et al.*: 'Statistical characterization of lightning induced overvoltage waveforms in overhead Lines'. 2019 IEEE Int. Conf. on Environment and Electrical Engineering and 2019 IEEE Industrial and Commercial Power Systems Europe (IEEEIC / I&CPS Europe), Genova, Italy, 2019, pp. 1–6
- [5] Rahiminejad, A., Vahidi, B.: 'Interfacing electromagnetic model of tower-footing impedance with the EMTP software package', *Int. J. Electr. Power Energy Syst.*, 2019, **105**, pp. 394–403
- [6] Banjanin, M.S., Savić, M.S., Stojković, Z.M.: 'Lightning protection of overhead transmission lines using external ground wires', *Electr. Power Syst. Res.*, 2015, **127**, pp. 206–212
- [7] Mahmood, F., Nehmdoh, A.S., Lehtonen, M.: 'Effect of combined AC and lightning-induced overvoltages on the risk of MV insulator flashovers above lossy ground', *Electr. Power Syst. Res.*, 2015, **127**, pp. 101–108
- [8] Sheshyekani, K., Akbari, M., Tabei, B., *et al.*: 'Wide-band modeling of large grounding systems to interface with electromagnetic transient solvers', *IEEE Trans. Power Deliv.*, 2014, **29**, (4), pp. 1868–1876
- [9] Alemi, M.R., Sheshyekani, K.: 'Wide-band modeling of tower-footing grounding systems for the evaluation of lightning performance of transmission lines', *IEEE Trans. Electromagn. Compat.*, 2015, **57**, (6), pp. 1627–1636
- [10] Young, F.S., Clayton, J.M., Hileman, A.R.: 'Shielding of transmission lines', *IEEE Trans. Power Appar. Syst.*, 1963, **S82**, pp. 132–154
- [11] Brown, G.W., Whitehead, E.R.: 'Field and analytical studies of transmission line shielding: part II', *IEEE Trans. Power Appar. Syst.*, 1969, **PAS-88**, (5), pp. 617–626

- [12] Ahmadi, H., Armstrong, M., Tavighi, A.: 'Quantifying the shielding effect of trees against lightning strikes for power transmission lines'. 2018 IEEE Canadian Conf. on Electrical & Computer Engineering (CCECE), Quebec City, Canada, 2018, pp. 1–5
- [13] Hashemian, P., Vahidi, B., Rahiminezhad, A.: 'Improved electro-geometric model for shielding failure analysis of transmission lines', *IET Gener. Transm. Distrib.*, 2018, **12**, (4), pp. 542–547
- [14] CIGRE Working Group C4.26. 'Evaluation of lightning shielding analysis methods for EHV and UHV DC and AC transmission lines', 2017
- [15] IEEE, 1243-1997, 'IEEE guide for improving the lightning performance of transmission lines', December 1997
- [16] <https://www.sonel.pl/en/product/earth-resistance-resistivity-meter-sonel-mru-200/>
- [17] Gilks, W.R., Richardson, S., Spiegelhalter, D.: 'Markov chain Monte Carlo in practice' (CRC Press, UK, 1995)
- [18] Shariatinasab, R., Gholinezhad, J., Sheshyekani, K., *et al.*: 'The effect of wide band modeling of tower-footing grounding system on the lightning performance of transmission lines: a probabilistic evaluation', *Electr. Power Syst. Res.*, 2016, **141**, pp. 1–10
- [19] Chowdhuri, P., Anderson, J., Chisholm, W., *et al.*: 'Parameters of lightning strokes: a review', *IEEE Trans. Power Deliv.*, 2005, **20**, pp. 346–358
- [20] Yang, X., Geng, G., Wang, Y., *et al.*: 'Method for accurately measuring the power-frequency parameters of EHV/UHV transmission lines', *Gener. Transm. Distrib. IET*, 2017, **11**, (7), pp. 1726–1734
- [21] Chen, X., Tang, Q., Tong, M.S.: 'An efficient approximation method for delay-rational model of multiconductor transmission lines', *IEEE Trans. Compon., Packag. Manuf. Technol.*, 2018, **8**, (12), pp. 2130–2139
- [22] Martinez, J.A.: 'Power system transients: parameter determination' (CRC Press, New York, USA, 2009)
- [23] Rioual, M.: 'Short and long air gaps (insulator strings and spark gaps) modelling for lightning studies with EMTP program (EPRI-DCG version 2.0)', Research Project, Final Report, March 88
- [24] Datsios, Z.G., Mikropoulos, P.N., Tsovilis, T.E.: 'Estimation of the minimum shielding failure flashover current for first and subsequent lightning strokes to overhead transmission lines', *Electr. Power Syst. Res.*, 2014, **113**, pp. 141–150
- [25] Wagner, C.F.: 'The relation between stroke current and the velocity of the return stroke', *IEEE Trans. Power Appar. Syst.*, 1963, **82**, (68), pp. 609–617
- [26] 'General technical specification and execution procedures for transmission and subtransmission networks - electrical transmission supports', issue no. 2

14 Appendix

Tower grounding system consisting of four horizontal branches made of strap iron buried at about 0.8 m is shown in Fig. 16. This grounding system is suitable for soil resistivity of 150–250 Ω m.

The used network in EMTP-RV is depicted in Fig. 17. As shown in this figure, seven towers and six spans with the length of 402 m are used to analyse the system performance. Moreover, two 90 km transmission lines are considered to terminate on both ends. It should be noted that since under-study transmission line is double ended, two voltage sources are connected to each end. Moreover, parameters of the voltage sources are determined based on load flow solution. As mentioned in this paper, 80 MW with power factor of 0.9 Lag is transferred through transmission line.

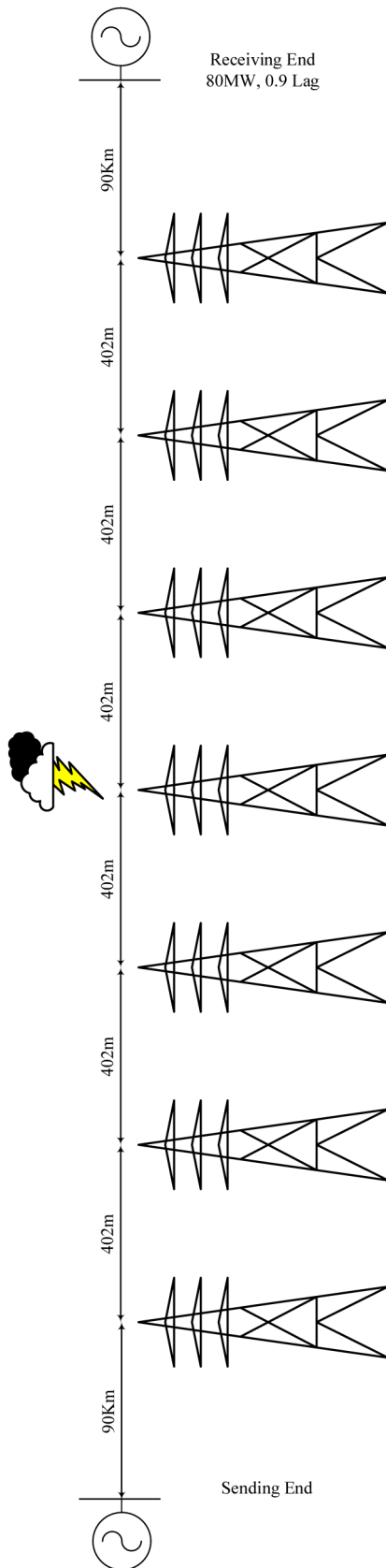

Fig. 17 Used network to simulate lightning