

PAPER

Real-time control of divertor detachment in H-mode with impurity seeding using Langmuir probe feedback in JET-ITER-like wall

To cite this article: C Guillemaut *et al* 2017 *Plasma Phys. Control. Fusion* **59** 045001

View the [article online](#) for updates and enhancements.

Related content

- [Overview of the JET results in support to ITER](#)
- [Experimental estimation of tungsten impurity sputtering due to Type I ELMs in JET-ITER-like wall using pedestal electron cyclotron emission and target Langmuir probe measurements](#)
- [Partial detachment of high power discharges in ASDEX Upgrade](#)

Recent citations

- [The first implementation of active detachment feedback control in EAST PCS](#)
Q.P. Yuan *et al*
- [Correcting for non-periodic behaviour in perturbative experiments: application to heat pulse propagation and modulated gas-puff experiments](#)
M van Berkel *et al*
- [Impurity transport and divertor retention in Ar and N seeded SOLPS 5.0 simulations for ASDEX Upgrade](#)
F Hitzler *et al*



IOP | ebooks™

Bringing together innovative digital publishing with leading authors from the global scientific community.

Start exploring the collection—download the first chapter of every title for free.

Real-time control of divertor detachment in H-mode with impurity seeding using Langmuir probe feedback in JET-ITER-like wall

C Guillemaut^{1,2}, M Lennholm³, J Harrison⁴, I Carvalho², D Valcarcel⁴,
R Felton⁴, S Griph⁴, C Hogben⁴, R Lucock⁴, G F Matthews⁴,
C Perez Von Thun⁵, R A Pitts⁶, S Wiesen⁵ and JET contributors⁷

¹EUROfusion Consortium, JET, Culham Science Centre, Abingdon, OX14 3DB, United Kingdom

²Instituto de Plasmas e Fusão Nuclear, Instituto Superior Técnico, Universidade de Lisboa, P-1049-001, Lisboa, Portugal

³European Commission, B-1049 Brussels, Belgium

⁴CCFE, Culham Science Centre, Abingdon OX14 3DB, United Kingdom

⁵Forschungszentrum Jülich GmbH, Institut für Energie- und Klimaforschung—Plasmaphysik, D-52425 Jülich, Germany

⁶ITER Organization, Route de Vinon-sur-Verdon, CS 90 046, F-13067 St. Paul Lez Durance Cedex, France

E-mail: christophe.guillemaut@ukaea.uk and cguillemaut@ipfn.ist.utl.pt

Received 14 September 2016, revised 6 January 2017

Accepted for publication 13 January 2017

Published 14 February 2017



CrossMark

Abstract

Burning plasmas with 500 MW of fusion power on ITER will rely on partially detached divertor operation to keep target heat loads at manageable levels. Such divertor regimes will be maintained by a real-time control system using the seeding of radiative impurities like nitrogen (N), neon or argon as actuator and one or more diagnostic signals as sensors. Recently, real-time control of divertor detachment has been successfully achieved in Type I ELMy H-mode JET-ITER-like wall discharges by using saturation current (I_{sat}) measurements from divertor Langmuir probes as feedback signals to control the level of N seeding. The degree of divertor detachment is calculated in real-time by comparing the outer target peak I_{sat} measurements to the peak I_{sat} value at the roll-over in order to control the opening of the N injection valve. Real-time control of detachment has been achieved in both fixed and swept strike point experiments. The system has been progressively improved and can now automatically drive the divertor conditions from attached through high recycling and roll-over down to a user-defined level of detachment. Such a demonstration is a successful proof of principle in the context of future operation on ITER which will be extensively equipped with divertor target probes.

Keywords: magnetic confinement fusion, real-time control, divertor detachment, Langmuir probes, impurity seeding, H-mode, JET-ILW

(Some figures may appear in colour only in the online journal)

⁷ See the appendix of Romanelli F and on behalf of JET Contributors 2015 *Nucl. Fusion* **55** 104001

1. Introduction: necessity of real-time detachment control on ITER

Deuterium–tritium discharges with 500 MW of fusion power on ITER will rely on partially detached divertor operations to keep target heat loads at manageable levels [1]. The baseline operation mode for burning plasmas on ITER is the Type I ELMy H-mode and will be achieved with a tungsten (W) divertor and a beryllium (Be) main chamber wall. Since W and Be are very poor radiators in the scrape-off layer (SOL), the seeding of impurities like nitrogen (N), neon (Ne) or argon (Ar) can be used to dissipate significant amounts of power radiatively. In ITER, $\sim 60\%$ of the SOL power must be radiated to maintain the peak divertor target power flux density at the technologically manageable level of $\sim 10 \text{ MW m}^{-2}$ [2]. Such levels of power dissipation will cool the target plasma electron temperature (T_e) down to values low enough that recombination and transport processes result in a reduction of the target particle flux and hence of the power density [3, 4].

The details of detachment control methods are not yet developed for ITER and it is one of the key issues to be addressed on current tokamaks, for many of which, divertor power flux control is not mandatory. Several devices are in fact now actively exploring different methodologies (see e.g. [5, 6] for ASDEX-Upgrade and [7] for C-mod) and this paper presents a new approach being developed at JET. For all-metal plasma-facing component (PFC) devices such as ASDEX-Upgrade, JET and ITER, seeded impurities are the only practical way to afford a sensitive and rapid enough actuator for detachment control. Indeed, on ITER, rapidity is particularly important given the actively cooled components and the need to avoid overheating at cooling tube/PFC interfaces, where rupture can occur if critical heat flux is exceeded.

Regarding sensors, the use of shunt resistors in the ASDEX-Upgrade divertor [5] or thermocouples embedded in the PFC front surfaces at C-Mod [7] have proven their worth for detachment control. Unfortunately, neither diagnostic will be available on ITER. The latter will, however, like many tokamaks, be equipped with extensive arrays of target Langmuir probes (LP) as well as comprehensive divertor target infer-red thermography, divertor spectroscopy (visible and VUV) and bolometry. The intention at present is to use these diagnostics, probably in combination, as sensors for feedback control of target heat fluxes.

In the case of LP, the degree of detachment, and hence power flux control can be achieved in principle in real time using, for example, ion saturation current (I_{sat}) measurements to detect the point at which roll-over (corresponding to divertor detachment onset, see [8]) in the peak values begins at either divertor target (inner or outer) and then feeding back on the impurity injection rate. It is this technique which has been recently attempted at JET, concentrating on the outer target (OT) where probe coverage is optimum. These proof-of-principle experiments for ITER are the subject of the report in this paper. Mention has to be made that detachment real-time control using LP feedback has already been attempted in JET

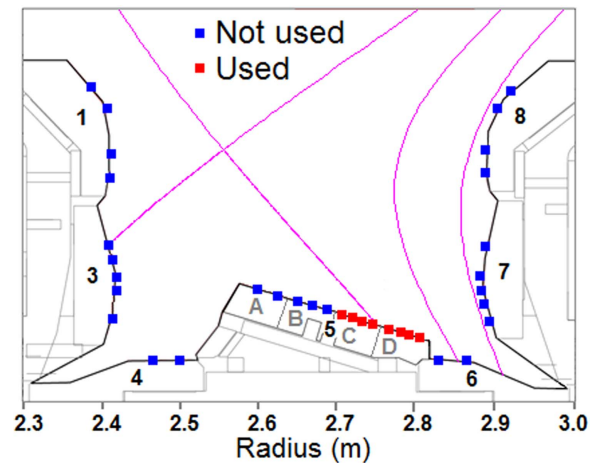

Figure 1. Horizontal outer target magnetic configuration in the JET-ILW divertor with LP locations (squares). Only the probes marked in red are used by the real-time detachment control system reported here.

in L-mode discharges with carbon PFC using deuterium fueling as actuator [9] but never in H-mode with metal PFC where seeding is needed and ELMs can perturbate strongly the real-time LP measurements.

The JET-ITER-like wall (ILW) [10] comprises a W divertor and Be main chamber, matching the material configuration planned for ITER. Real-time detachment control with N seeding and LP feedback has been attempted in several dedicated JET-ILW Type I ELMy H-mode experiments. The discharges have been achieved with a toroidal field of 2.2 T, a plasma current of 2 MA, 8 MW of neutral beam injection heating and 2 MW of ion cyclotron resonance heating. The divertor configuration featured a vertical inner target with a horizontal OT and the detachment real-time control system used 8 of the OT LP (see red squares in figure 1). The system is described in details in section 2 and has gradually evolved in complexity from the first experimental attempts (section 3) to become a nearly fully automated system in the most recent experiments (section 4).

2. Description of the detachment real-time control system on JET

The divertor LP are placed at 36 poloidal locations in three different (toroidally separated) divertor modules, see figure 1. For the real-time detachment control experiments, they are operated in saturation current with a constant voltage bias at $\sim -150 \text{ V}$ interrupted every 20 ms with a brief excursion to $\sim 5 \text{ V}$ (see figure 2) to prevent damage due to arcing. The detachment control system presented here can use up to 16 simultaneous Langmuir probe signals in real-time, but for the experiments described in this paper, only 8 signals have been used from the set of probes located on the low field side of the bulk-W outer divertor Tile 5. As shown in the control schematic diagram in figure 3, I_{sat} measurements are sent to the UXD7 data acquisition unit with a sample frequency of 100 kHz. The signals are first digitalized and then temporarily

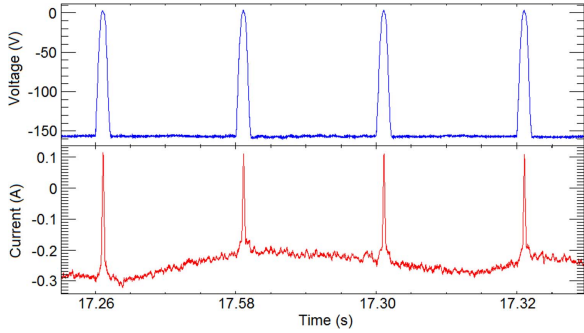

Figure 2. Top: LP voltage wave form used for real-time detachment control; bottom: corresponding I_{sat} measurements.

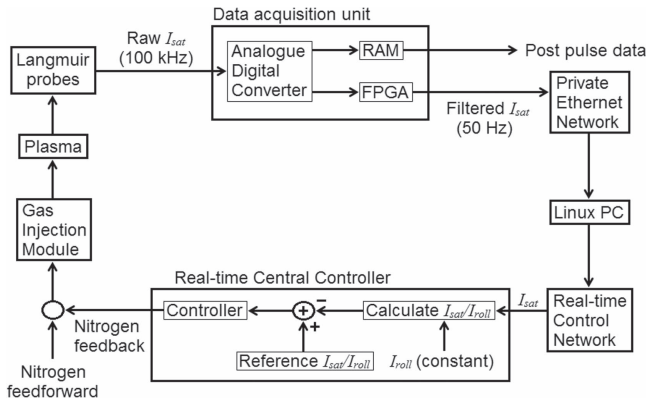

Figure 3. Diagram of the real-time detachment control system with LP feedback.

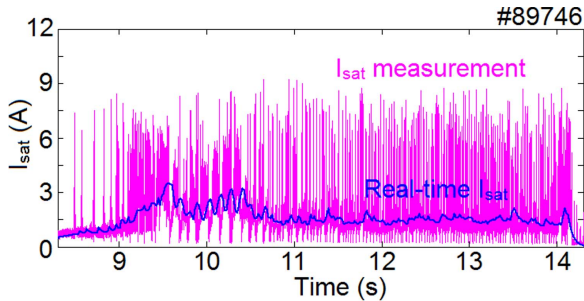

Figure 4. Example of LP I_{sat} measurements (magenta curve) with its corresponding down-sampled and filtered real-time I_{sat} (blue curve).

stored in random access memory during the discharge before being permanently saved as files after the discharge.

As also shown in figure 3, the generation of LP real-time data requires the use of a new channel involving a field programmable gate array (FPGA) to filter and down-sample the I_{sat} data to a much lower frequency in order to be handled by the real-time network. The latter cannot work with a sampling rate higher than 250 Hz. The FPGA is used as a low-pass filter with a cut-off frequency set at 50 Hz to eliminate the anti-arcing ‘blips’ and the ELMs. The filtered signal is averaged over 20 ms periods which reduces the I_{sat} sampling rate down to 50 Hz. The resulting real-time I_{sat} corresponds to inter-ELM conditions (figure 4) and is fast compared to the ~ 1 s response time of the N injection system.

The real-time signals are first sent on a private Ethernet network where the channels can be configured in a Linux PC before being transferred to the general JET real-time control network. The I_{sat} signals can then be used by the real-time central controller (RTCC). At any time t during the discharge, the RTCC creates an $I_{\text{sat}}(t)$ value as the highest saturation current found amongst the 8 real-time signals coming from the red probes in figure 1 and compares it to the peak I_{sat} value found at roll-over of the current I_{roll} , calculating the attachment fraction $A_{\text{frac}}(t)$ such that:

$$A_{\text{frac}}(t) = \frac{I_{\text{sat}}(t)}{I_{\text{roll}}} \quad (1)$$

I_{roll} can be set before the experiments using data from previous similar detachment discharges without controller or it can be found automatically by the controller. These features will be discussed in sections 3 and 4 below.

The JET-ILW real-time detachment control experiments described here start with an attached plasma. In the first phase of the discharge the N seeding is controlled to reach the roll-over at a time t_{roll} when:

$$\max(I_{\text{sat}}(t_{\text{roll}})) = I_{\text{roll}} \quad (2)$$

and then the controller continues the N seeding until the attachment fraction A_{ref} requested before the discharge is achieved such that:

$$\frac{\max(I_{\text{sat}}(t))}{I_{\text{roll}}} = A_{\text{ref}}. \quad (3)$$

The RTCC calculates a real-time *Error* as follows:

$$\text{Error}(t) = A_{\text{ref}} - \frac{I_{\text{sat}}(t)}{I_{\text{roll}}} \quad (4)$$

and this error is then sent to a proportional-integral controller in order to generate the percentage of aperture $A(t)$ of the N injection piezo-electric valve using the gains G and the time constant τ as follows:

$$A(t) = G \left(\text{Error}(t) + \frac{1}{\tau} \int_0^t \text{Error}(t') dt' \right), \quad (5)$$

where t' is the time variable of integration.

G controls the sensitivity of the controller to the feedback signal: the higher the gain, the higher the sensitivity. τ weights the integral term (second term) compared to the proportional term (first term) and has been kept constant at $\tau = 2$ s. In the most basic version of the controller, I_{roll} and G are set before the discharge by the user (see section 3 below) while more advanced controllers can calculate these parameters in real-time (see section 4 below).

3. First experimental detachment control attempts with basic controller

3.1. Fixed strike point

The first attempt at detachment real-time control with LP feedback in JET-ILW H-mode discharges has been achieved with fixed outer strike point position, see figure 1. The values

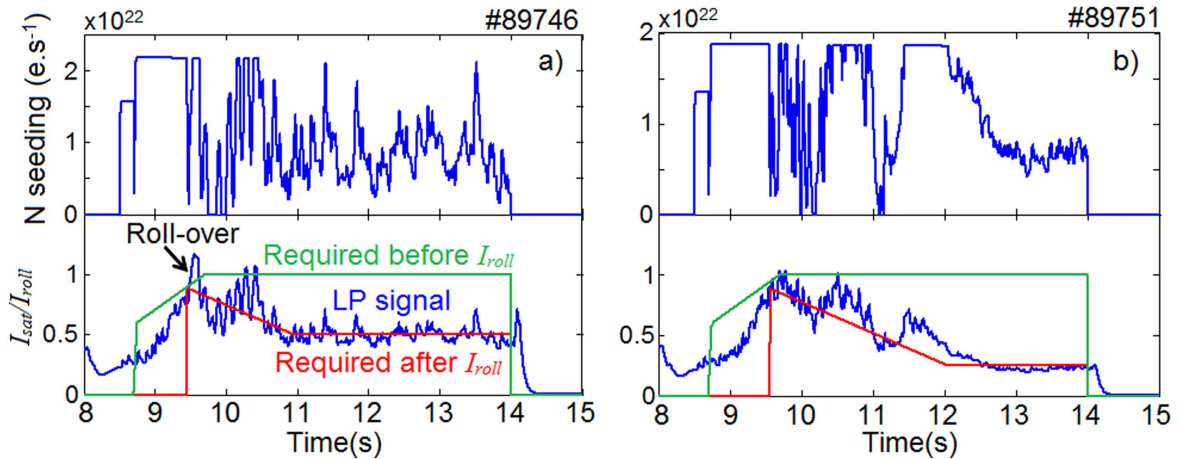

Figure 5. (a) Top: N injection rate time trace. Bottom: real-time attachment fraction time trace (blue curve) with pre-roll-over request (green curve) and post-roll-over request (red curve) for discharge #89 746. (b) Same as (a) for discharge #89 751.

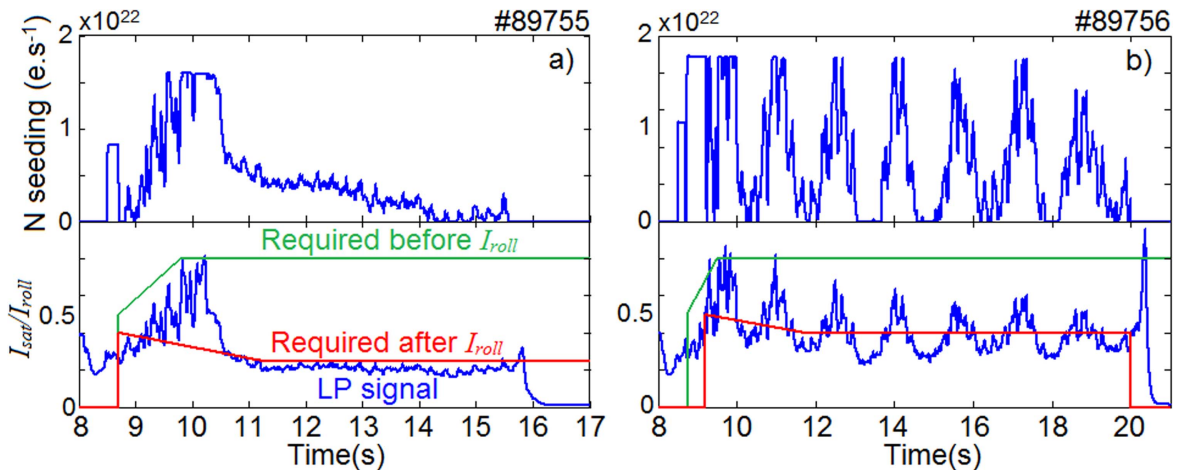

Figure 6. Same as figure 5 for discharges with divertor sweeping: (a) discharge #89 755 and (b) discharge #89 756.

for I_{roll} and G were set before the experiments using data from previous similar detachment discharges without controller. In the first attempt, in discharge #89 746, an increase of A_{frac} from 0.5 to 1 was requested in order to bring the plasma from fully attached conditions to roll-over. At the roll-over the sign of the controller gain has to change, since a further increase in the impurity injection leads to a reduction of I_{sat} . This is handled by ensuring that once $I_{sat} = 0.8I_{roll}$, the controller sign is changed and the requested A_{frac} is set to a value decreasing linearly for 1.5 s and then kept stable at $A_{ref} = 0.5$. The progressive linear decrease of the attachment fraction was necessary to avoid too strong N seeding rates which could have brought A_{frac} lower than A_{ref} . As shown in figure 5(a), in discharge #89 746, $A_{frac} = A_{ref} = 0.5$ has been achieved at 11 s and maintained for 3 s until the end of the discharge at 14 s.

As shown in figure 5(b), a second successful attempt of real-time detachment control has been achieved in #89 751 with $A_{frac} = A_{ref} = 0.25$ maintained for the last ~ 2 s of the discharge. In both discharges #89 746 and #89 751, the level of detachment of the OT plasma appears to be very sensitive

to the N seeding rate just after the roll-over and less sensitive once the required partially detached steady-state is reached. Therefore, G should ideally be variable and have a low value around the roll-over and a high value once the requested detachment level is nearly reached. In #89 746 and #89 751, G was set at a constant high value to facilitate the stabilization of the partially detached phase with the risk of generating oscillations in the A_{frac} signal after the roll-over, as observed in figure 5(b).

3.2. Swept strike point

On JET-ILW Tile 5 (see figure 1) is made up of four separate stacks containing a series of solid W lamellas [11]. For target power load spreading, it is sometimes necessary to sweep the strike point between different stacks of Tile 5 (figure 1) during JET-ILW operations and it may also be a possibility for ITER. Additional real-time detachment control experiments were therefore attempted in H-mode discharges with a swept outer strike point. In pulses #89 755 and #89 756, the outer strike point was swept between stacks C and D

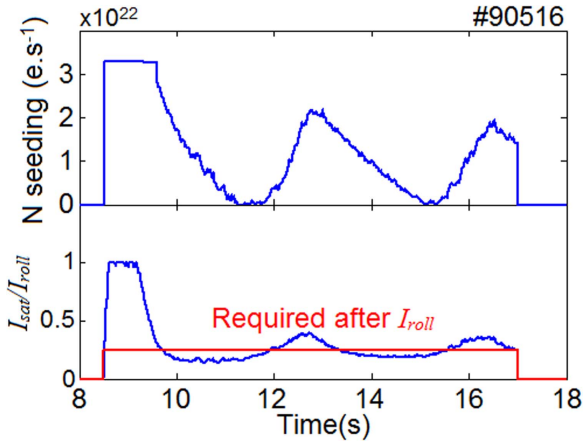

Figure 7. Same as figure 6 for discharge #90 516. No pre-roll-over request was necessary since the controller was using the automatic roll-over search feature.

(figure 1) at a frequency of 4 Hz and G was kept constant (similarly to the experiments described in section 3.1).

Since the OT peak I_{sat} moves from one probe to another during the sweep, it is not measured in between probes on Tile 5 (figure 1). Therefore, the averaging performed after the low-pass filtering in the FPGA reduces the measured roll-over I_{sat} to $\sim 70\%$ – 80% of the reference I_{roll} obtained from fixed strike point detachment experiments. It was thus necessary to adapt the controller to switch from pre-roll-over requirement to post-roll-over requirements (figures 6(a) and (b)) when $I_{\text{sat}} = 0.5I_{\text{roll}}$.

In #89 755 and #89 756 (figure 6), the requested A_{ref} were 0.25 and 0.5, respectively. In #89 756, the modest I_{sat} reduction placed the OT plasma in conditions where A_{frac} is still very sensitive to N seeding. This is why the high gain which was suitable for #89 755 drove strong oscillations in #89 756, see figures 6(a) and (b). It is, however, clear evidence that the real-time detachment control system based on LP feedback works and is very sensitive to divertor target conditions. A more automated system would nevertheless be required to be relevant for JET-ILW and ITER operations.

4. Automation of the detachment real-time controller

4.1. Automatic I_{sat} roll-over search

In a fully automated system, the controller should not have to rely on previous reference detachment experiments or code predictions and should therefore have the ability to find the roll-over on its own. An upgrade of the system containing this new feature has been tested on JET in the same type of H-mode discharge as for the previous real-time detachment control experiments discussed in section 3.

The main requirement of this more evolved controller is to start the control of the N injection valve while the OT plasma is still attached. In the initial attached phase, the controller runs in feedforward and opens the N injection valve to the maximum allowed (45% of full aperture). It continuously compares the instantaneous peak I_{sat} with the maximum reached since the beginning of the controlled period and switches to feedback control once A_{frac} is 10% above the requested A_{ref} . As for the earlier tests of the controller, the gain was fixed during these new experiments to a value chosen before the pulses were run.

This controller has been tested with success in discharge #90 516 where A_{frac} reached 0.25, as requested, see figure 7. However, the gain of the controller was too high and this is the reason for the very clear oscillations that can be seen in figure 7. To avoid this problem, the controller should be able to adapt the value of G automatically depending on the OT conditions.

4.2. Automatic gain adaptation

For a stable, oscillation-free control system, high sensitivity of the plasma to the N valve aperture just after the roll-over should be compensated by a low controller gain. On the other hand, low plasma sensitivity to N injection in deeply detached conditions should be compensated by a higher gain for the controller. Such features have been implemented in another upgraded controller and tested in JET-ILW H-mode experiments.

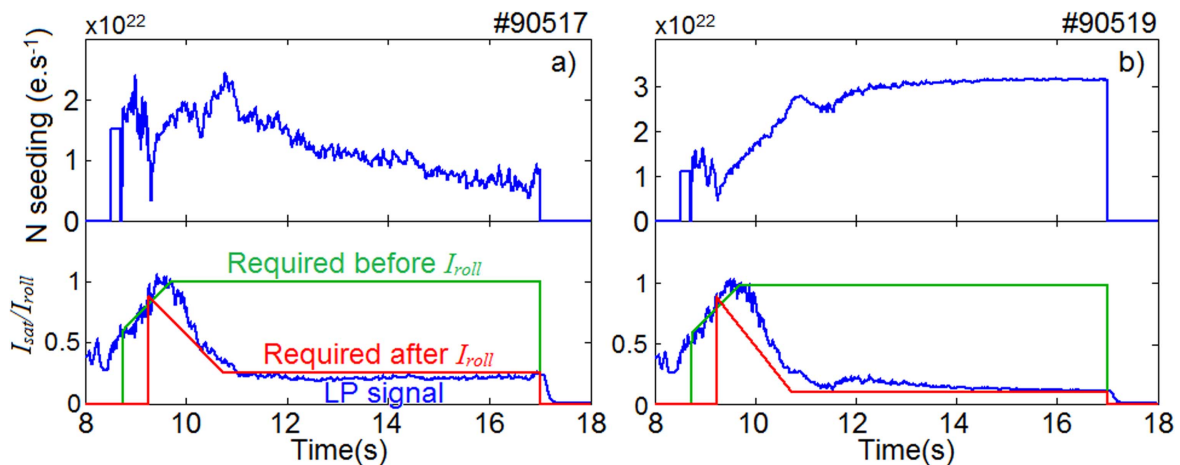

Figure 8. Same as figure 6 for discharges using the variable gain controller: (a) discharge #90 517 and (b) discharge #90 519.

It should be noted that this development is independent of the automatic roll-over search feature discussed in the previous section. Both upgrades have been tested separately and have not yet been merged. Thus, it was still necessary to program a pre-roll-over phase with an I_{roll} value obtained from previous detachment reference experiments. For automatic gain adaptation, it has been found by fitting $G(I_{\text{sat}})$ from previous stable detachment real-time control experiments that G should vary as follows:

$$G = \exp[-1.62(A_{\text{frac}} - 0.5)]. \quad (6)$$

The successful results from discharges #90 517 and #90 519 shown in figures 8(a) and (b) have been obtained by varying G according to (6). Respectively, $A_{\text{frac}} = 0.3$ and 0.1 have been achieved as requested in these discharges, without oscillations.

5. Conclusions

Burning plasmas with 500 MW of fusion power on ITER will rely on partially detached divertor operation to keep heat loads on the actively cooled components at manageable levels. This will require real-time control of the target heat flux, using extrinsic seeding impurities as the principal actuator to control the level of radiative dissipation and one or more diagnostic signals as sensors. One possible sensor, with which ITER will be well equipped, is an array of LP measuring the magnitude and spatial distribution of the particle flux to the target. This can be used as a real-time monitor of the degree of detachment and hence as a control parameter for the throughput of the impurity gas injection system.

To provide a proof of principle for ITER, real-time detachment control with nitrogen seeding and feedback on ion currents measured by an array of target Langmuir probes has been attempted, and successfully achieved, in several dedicated JET-ILW Type I ELMy H-mode experiments. The system developed for JET has demonstrated detachment control with fixed and swept outer strike point in a configuration with horizontal OT and inner vertical target. It has been shown that the ion current roll-over at the OT can be found automatically, providing that the control starts in attached divertor conditions. It has also been demonstrated

that the gain of the controller can be automatically adapted in real-time to avoid oscillations of the system.

This system could be useful for JET operations with impurity seeding and could be coupled with other real-time controllers. Given the success of these first attempts, additional tests are foreseen in different divertor configurations (vertical targets at both inner and outer) and also with other impurities such as Ne, Ar or CD₄. The next trials should involve a fully automatic system capable of driving the divertor plasma from attached conditions down to the requested detached state by coupling the adaptive gain and roll-over search features presented here. The system should also demonstrate that it is robust to changing conditions as it may be expected in ITER.

Acknowledgments

This work has been carried out within the framework of the EUROfusion Consortium and has received funding from the Euratom research. IST activities also received financial support from 'Fundação para a Ciência e Tecnologia' through project UID/FIS/50010/2013. The views and opinions expressed herein do not necessarily reflect those of the ITER Organization or of the European Commission.

References

- [1] Pitts R A *et al* 2011 *J. Nucl. Mater.* **415** S957–64
- [2] Pitts R A *et al* 2009 *Phys. Scr.* **T138** 014001
- [3] Guillemaut C *et al* 2014 *Nucl. Fusion* **54** 093012
- [4] Guillemaut C *et al* 2016 *PSI* (<https://doi.org/10.1016/j.nme.2017.02.010>)
- [5] Kallenbach A *et al* 2010 *Plasma Phys. Control. Fusion* **52** 055002
- [6] Kallenbach A *et al* 2012 *Nucl. Fusion* **52** 122003
- [7] Brunner D *et al* 2016 *Rev. Sci. Instrum.* **87** 023504
- [8] Stangeby P C 2000 *The Plasma Boundary of Magnetic Fusion Devices* (New York: Taylor and Francis)
- [9] JET TEAM 1995 *Proc. 15th Int. Conf. Plasma Physics and Controlled Nuclear Fusion Research 1994* vol 1(Seville, 1994) (Vienna: IAEA) p 527 (presented by D.J. CAMPBELL)
- [10] Matthews G F *et al* 2011 *Phys. Scr.* **2011** 014001
- [11] Mertens P *et al* 2011 *J. Nucl. Mater.* **415** S943–7